

# x530L Series

Stackable Gigabit Layer 3+ Ethernet Switches  
AlliedWare Plus™ v5.5.0-2

- x530L-10GHXm
- x530L-18GHXm
- x530L-28GPX
- x530L-28GTX
- x530L-52GPX
- x530L-52GTX

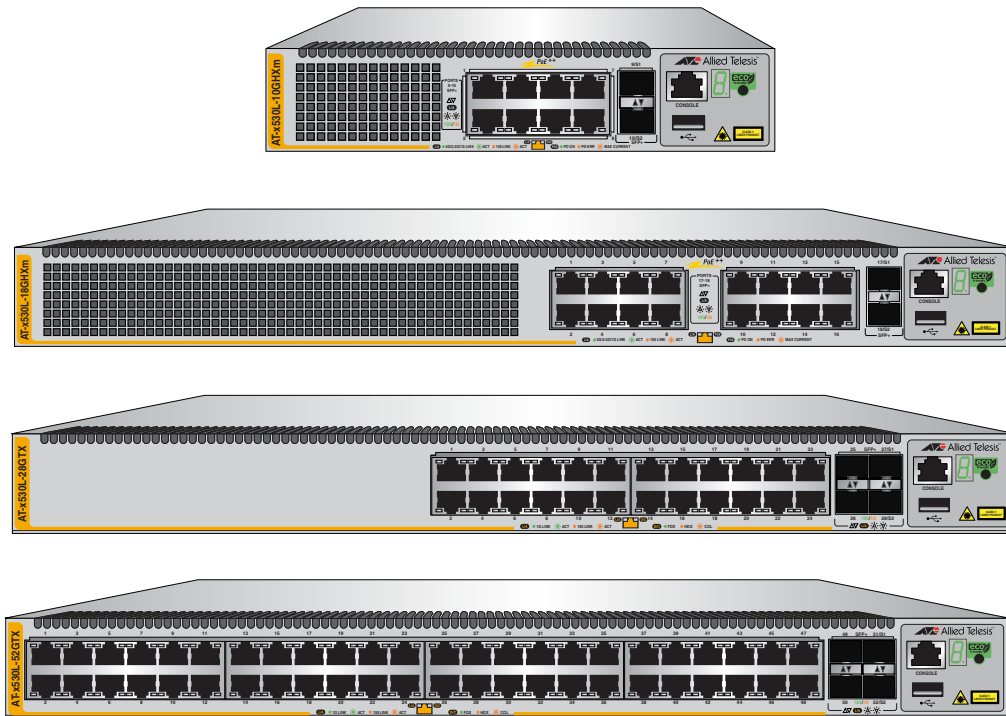

## Installation Guide for Virtual Chassis Stacking

Copyright © 2022 Allied Telesis, Inc.

All rights reserved. No part of this publication may be reproduced without prior written permission from Allied Telesis, Inc.

Allied Telesis, VCStack, and the Allied Telesis logo are trademarks of Allied Telesis, Incorporated. All other product names, company names, logos or other designations mentioned herein are trademarks or registered trademarks of their respective owners.

Allied Telesis, Inc. reserves the right to make changes in specifications and other information contained in this document without prior written notice. The information provided herein is subject to change without notice. In no event shall Allied Telesis, Inc. be liable for any incidental, special, indirect, or consequential damages whatsoever, including but not limited to lost profits, arising out of or related to this manual or the information contained herein, even if Allied Telesis, Inc. has been advised of, known, or should have known, the possibility of such damages.

# Electrical Safety and Emissions Standards

---

This product meets the following standards.

## U.S. Federal Communications Commission

### Radiated Energy

Note: This equipment has been tested and found to comply with the limits for a Class A digital device pursuant to Part 15 of FCC Rules. These limits are designed to provide reasonable protection against harmful interference when the equipment is operated in a commercial environment. This equipment generates, uses, and can radiate radio frequency energy and, if not installed and used in accordance with this instruction manual, may cause harmful interference to radio communications. Operation of this equipment in a residential area is likely to cause harmful interference in which case the user will be required to correct the interference at his own expense.

Note: Modifications or changes not expressly approved of by the manufacturer or the FCC, can void your right to operate this equipment.

## Industry Canada

This Class A digital apparatus complies with Canadian ICES-003.

Cet appareil numérique de la classe A est conforme à la norme NMB-003 du Canada.

RFI Emissions: FCC Class A, EN55032 Class A, EN61000-3-2, EN61000-3-3, VCCI Class A, CE

**Warning:** In a domestic environment this product may cause radio interference in which case the user may be required to take adequate measures.

EMC (Immunity): EN55024

Electrical Safety: EN62368-1 (TUV), UL 60950-1 (cUL<sub>US</sub>)



Laser Safety

EN60825

## Translated Safety Statements

---

**Important:** Safety statements that have the  symbol are translated into multiple languages in the *Translated Safety Statements* document at [www.alliedtelesis.com/library](http://www.alliedtelesis.com/library).

**Remarque:** Les consignes de sécurité portant le symbole  sont traduites dans plusieurs langues dans le document *Translated Safety Statements*, disponible à l'adresse [www.alliedtelesis.com/library](http://www.alliedtelesis.com/library).



# Contents

---

<b>Preface:</b> .....	15
Document Conventions .....	16
Contacting Allied Telesis .....	17
<b>Chapter 1: Overview</b> .....	19
Front and Rear Panels .....	20
Management Panel .....	23
Features .....	24
x530L Models .....	24
Twisted Pair Ports .....	24
Power Over Ethernet .....	25
SFP+ Transceiver Ports .....	27
LEDs .....	28
Installation Options .....	28
Management Software and Interfaces .....	28
Management Methods .....	28
Twisted Pair Ports .....	29
Duplex Mode .....	34
Wiring Configuration .....	35
Cable Requirements .....	35
Port Pinouts .....	35
LEDs .....	36
Power Over Ethernet .....	44
PoE Standards .....	44
Powered Device Classes .....	45
Power Budget .....	45
Port Prioritization .....	46
Wiring Implementation .....	47
SFP+ Transceiver Ports .....	48
1Gbps/10 Gbps SFP or SFP+ Transceivers .....	48
LEDs .....	48
eco-friendly Button .....	50
VCStack Feature .....	51
Switch ID LED .....	52
USB Port .....	54
Console Port .....	55
Power Supply .....	56
Pre-Installed AC Power Supply .....	56
Software and Hardware Releases .....	57
<b>Chapter 2: Virtual Chassis Stacking</b> .....	59
Overview .....	60
Stacking Guidelines .....	61
Stack Trunks .....	63
Stack Trunks of 10Gbps Ports .....	64
Stack Trunks of 5Gbps Ports on the x530L-10GHXm or x530L-18GHXm Switch .....	74
Invalid Stack Trunks .....	77
Example 1 .....	77
Example 2 .....	77
Example 3 .....	78

Example 4.....	78
Master and Member Switches .....	79
Selection of the Master Switch .....	79
Switch ID Numbers .....	81
Optional Feature Licenses .....	82
Mixed Switch Stacks .....	83
Stack Mixed-Mode Licenses.....	84
Stack Mixed-Mode Commands.....	84
Trunk Ports .....	84
Optional Licenses .....	84
AlliedWare Plus .....	84
Guidelines.....	84
Planning the Stack.....	86
Configuring Mixed-Mode VCStacking.....	87
Stacking Worksheet.....	88
<b>Chapter 3: Beginning the Installation .....</b>	<b>91</b>
Reviewing Safety Precautions .....	92
Choosing a Site for the Switch.....	97
Unpacking the x530L-10GHXm Switch.....	98
Unpacking the x530L-18GHXm Switch.....	101
Unpacking the x530L-28GTX, x530L-28GPX, x530L-52GTX, or x530L-52GPX Switch .....	103
<b>Chapter 4: Installing the Switch on a Table .....</b>	<b>105</b>
Installing the Bumper Feet.....	106
<b>Chapter 5: Installing the Switch in an Equipment Rack .....</b>	<b>109</b>
Overview of Installing the x530L-10GHXm Switch in an Equipment Rack .....	110
Installing the x530L-10GHXm Switch in an Equipment Rack with the RKMT-J14 Brackets.....	112
Required Items .....	112
Switch Orientations in the Equipment Rack.....	112
Installing the Switch .....	114
Installing the x530L-10GHXm Switch in an Equipment Rack with the RKMT-J15 Bracket .....	117
Required Items .....	117
Installing the Switch .....	117
Installing the x530L-18GHXm, x530L-28GTX, x530L-28GPX, x530L-52GTX, or x530L-52GPX Switch in an Equipment Rack .....	123
Required Items .....	123
Switch Orientations in the Equipment Rack.....	123
Installing the Switch .....	124
<b>Chapter 6: Installing the Switch on a Wall .....</b>	<b>127</b>
Switch Orientations on a Wall.....	128
Installation Guidelines.....	130
Tools and Material.....	131
Plywood Base for a Wall with Wooden Studs.....	133
Installing a Plywood Base .....	134
Installing the Switch on a Plywood Base .....	135
Installing the Switch on a Concrete Wall.....	140
<b>Chapter 7: Building the Trunk with the Default 10Gbps Stacking Ports .....</b>	<b>143</b>
Introduction .....	144
Installing the Power Cord Retaining Clip(s) .....	145
Powering On the Switches Individually .....	146
Powering On the Switches Simultaneously .....	150
Starting a Local Management Session .....	152
Verifying the Stack.....	155
Adding Ports 25 and 26 on the x530L-28GPX or x530L-28GTX Switch to the Stack Trunk .....	156
Adding Ports 49 and 50 on the x530L-52GPX or x530L-52GTX Switch to the Stack Trunk .....	158
Monitoring the Initialization Processes.....	160
<b>Chapter 8: Building the Stack Trunk with 5Gbps Multi-Speed Ports .....</b>	<b>163</b>
Introduction.....	164

Command Summary .....	165
STACKPORT .....	165
STACK ENABLE .....	166
STACK PRIORITY .....	166
STACK RENUMBER .....	167
SWITCH PROVISION .....	167
Configuring the Master x530L-10GHXm Switch .....	168
General Steps for the Master x530L-10GHXm Switch .....	168
Configuring the Master x530L-10GHXm Switch – Part I .....	169
Configuring the Master x530L-10GHXm Switch – Part II .....	172
Verifying the x530L-10GHXm Master Switch .....	174
Configuring the Master x530L-18GHXm Switch .....	177
General Steps for the Master x530L-18GHXm Switch .....	177
Configuring the Master x530L-18GHXm Switch – Part I .....	178
Configuring the Master x530L-18GHXm Switch – Part II .....	181
Verifying the Master x530L-18GHXm Switch .....	183
What to Do Next .....	186
<b>Chapter 9: Cabling the Networking Ports</b> .....	187
Cabling Twisted Pair Ports .....	188
Guidelines to Handling SFP and SFP+ Transceivers .....	189
Installing SFP or SFP+ Transceivers in the Switches .....	190
Installing SP10TW Direct Connect Twinax Cables in the Switches .....	192
<b>Chapter 10: Troubleshooting</b> .....	195
<b>Appendix A: Technical Specifications</b> .....	199
Physical Specifications .....	200
Environmental Specifications .....	204
Power Specifications .....	205
Certifications .....	207
RJ-45 Twisted Pair Port Pinouts .....	208
RJ-45 Style Serial Console Port Pinouts .....	210
USB Port .....	211



# Figures

---

Figure 1: x530L-10GHXm Front Panel .....	20
Figure 2: x530L-18GHXm Front Panel .....	20
Figure 3: x530L-28GTX Front Panel .....	20
Figure 4: x530L-28GPX Front Panel .....	21
Figure 5: x530L-52GTX Front Panel .....	21
Figure 6: x530L-52GPX Front Panel .....	21
Figure 7: x530L-10GHXm Back Panel .....	22
Figure 8: x530L-18GHXm Back Panel .....	22
Figure 9: x530L-52GPX and x530L-28GPX Back Panel .....	22
Figure 10: x530L-52GTX and x530L-28GTX Back Panel .....	22
Figure 11: Management Panel .....	23
Figure 12: x530L-10GHXm Twisted Pair Ports .....	36
Figure 13: x530L-18GHXm Twisted Pair Ports .....	37
Figure 14: x530L-28GTX Twisted Pair Port LEDs .....	39
Figure 15: x530L-52GTX Twisted Pair Port LEDs .....	40
Figure 16: x530L-28GPX Twisted Pair Ports .....	41
Figure 17: x530L-52GPX Twisted Pair Ports .....	42
Figure 18: Link and Activity LEDs for the 1Gbps SFP/10Gbps SFP+ Ports .....	48
Figure 19: Switch ID LED .....	52
Figure 20: Switch ID LED Description .....	53
Figure 21: Valid Stack Trunk Using Default Stacking Ports 9 to 10 on 10-Port x530L Switches .....	65
Figure 22: Valid Stack Trunk Using Default Stacking Ports 17 to 18 on 18-Port x530L Switches .....	66
Figure 23: Valid Stack Trunk Using Default Stacking Ports 27 to 28 on 28-Port x530L Switches .....	67
Figure 24: Valid Stack Trunk Using Default Stacking Ports 51 to 52 on 52-Port x530L Switches .....	68
Figure 25: Valid Stack Trunks Using Ports 25 to 28 .....	70
Figure 26: Valid Stack Trunks Using a Combination of Ports 25 to 28 and Ports 49 to 52 .....	71
Figure 27: Valid Stack Trunks Using a Combination of Ports 7 to 10 and Ports 15 to 18 .....	72
Figure 28: Valid 10Gbps Stack Trunk with Both Fiber Optic and SP10TW Direct Connect Cables .....	73
Figure 29: Trunks of 5Gbps Ports for Stacks of Two x530L-10GHXm Switches .....	75
Figure 30: Trunks of 5Gbps Ports for Stacks of Three x530L-10GHXm Switches .....	76
Figure 31: Invalid Stack Trunk with an Intermediary Networking Device .....	77
Figure 32: Invalid Stack Trunk with One Port Used Per Switch .....	77
Figure 33: Invalid Stack Trunk with Different Numbers of Links .....	78
Figure 34: Invalid Stack Trunk with Different Port Types .....	78
Figure 35: x530L-10GHXm Switch Shipping Box .....	98
Figure 36: x530L-10GHXm Switch Accessory Kit .....	99
Figure 37: x530L-10GHXm Switch Accessory Kit (Continued) .....	100
Figure 38: x530L-18GHXm Switch Shipping Box .....	101
Figure 39: x530L-18GHXm Switch Accessory Kit .....	102
Figure 40: 28- or 52-Port Switch Shipping Box .....	103
Figure 41: 28- or 52-Port Accessory Kit Items .....	104
Figure 42: Parts of the Bumper Feet .....	106
Figure 43: Holes for Bumper Feet .....	106
Figure 44: Inserting the Rivet Housing into the Bumper Foot .....	107
Figure 45: Placing the Bumper Foot on a Base Corner Hole .....	107
Figure 46: Inserting the Rivet into the Bumper Foot .....	108
Figure 47: RKMT-J14 Brackets and Switch .....	110
Figure 48: RKMT-J15 Bracket .....	110
Figure 49: RKMT-J15 Bracket with Switches .....	111

Figure 50: Bracket Holes .....	112
Figure 51: RKMT-J14 Bracket Holes .....	113
Figure 52: Switch Orientations with the Front Panel Facing the Front of the Equipment Rack .....	113
Figure 53: Switch Orientations with the Rear Panel Facing the Front of the Equipment Rack .....	114
Figure 54: Attaching the Handles to the RKMT-J14 Brackets .....	115
Figure 55: Attaching the RKMT-J14 Brackets to the Switch .....	115
Figure 56: Installing the Switch in an Equipment Rack .....	116
Figure 57: Installing the RKMT-J15 Bracket in the Equipment Rack .....	118
Figure 58: Loosening the Two Thumbscrews on the Front of the RKMT-J15 Bracket .....	118
Figure 59: Sliding Out the Bracket of the RKMT-J15 .....	119
Figure 60: Removing the Plastic Feet from the Bottom Panel of the Switch .....	119
Figure 61: Placing the x530L-10GHXm Switch in the RKMT-J15 Bracket .....	120
Figure 62: Securing the x530L-10GHXm Switch to the RKMT-J15 Bracket .....	120
Figure 63: Sliding in the Bracket .....	121
Figure 64: Tightening the Two Thumbscrews on the RKMT-J15 bracket .....	121
Figure 65: Bracket Holes on the Switch .....	123
Figure 66: Switch Orientations in an Equipment Rack .....	124
Figure 67: Example of Attaching the Brackets to the Switch .....	125
Figure 68: Installing the Switch in an Equipment Rack .....	126
Figure 69: Positioning the x530L-28GTX or x530L-52GTX Switch on the Wall .....	128
Figure 70: Positioning the x530L-10GHXm, x530L-18GHXm, x530L-28GPX or x530L-52GPX Switch on the Wall .....	129
Figure 71: Switch on the Wall with a Plywood Base .....	133
Figure 72: Installing the Plywood Base to the Wall .....	134
Figure 73: Installing Two Brackets on the x530L-28GTX or x530L-52GTX Switch .....	136
Figure 74: Installing Four Brackets on the x530L-10GHXm, x530L-18GHXm, x530L-28GPX and x530L-52GPX Switches .....	137
Figure 75: Securing the x530L-28GTX or x530L-52GTX Switch to the Plywood Base .....	138
Figure 76: Securing the x530L-10GHXm, x530L-18GHXm, x530L-28GPX or x530L-52GPX Switch to the Plywood Base .....	139
Figure 77: Marking the Locations of the Bracket Holes on a Concrete Wall .....	141
Figure 78: Installing the Switch on a Concrete Wall .....	142
Figure 79: Installing the Retaining Clip .....	145
Figure 80: Plugging in the AC Power Cord to the Switch .....	147
Figure 81: Lowering the Power Cord Retaining Clip .....	147
Figure 82: Plugging in the AC Power Cord to an AC Source .....	148
Figure 83: Management Cable Included with Switch .....	152
Figure 84: VT-Kit3 Management Cable .....	152
Figure 85: Management Workstation, VT-Kit3 Management Cable, and Switch .....	153
Figure 86: Connecting the Management Cable to the Console Port .....	153
Figure 87: Switch Initialization Messages .....	160
Figure 88: Switch Initialization Messages (Continued) .....	161
Figure 89: Switch Initialization Messages (Continued) .....	162
Figure 90: Powering Off the Switch .....	186
Figure 91: Installing an SFP Transceiver .....	190
Figure 92: Positioning the SFP or SFP+ Handle in the Upright Position .....	191
Figure 93: Connecting a Fiber Optic Cable to an SFP or SFP+ Transceiver .....	191
Figure 94: Installing SP10TW Cables .....	193
Figure 95: x530L-10GHXm .....	200
Figure 96: x530L-18GHXm .....	201
Figure 97: x530L-28GTX .....	201
Figure 98: x530L-28GPX .....	201
Figure 99: x530L-52GTX .....	202
Figure 100: x530L-52GPX .....	202
Figure 101: RJ-45 Socket Pin Layout (Front View) .....	208

# Tables

---

Table 1: Basic Features .....	22
Table 2: x530L-10GHXm Switch Twisted Pair Port Specifications .....	26
Table 3: x530L-28GTX Switch Twisted Pair Port Specifications .....	27
Table 4: x530L-28GPX Switch Twisted Pair Port Specifications .....	28
Table 5: x530L-52GTX Switch Twisted Pair Port Specifications .....	29
Table 6: x530L-52GPX Switch Twisted Pair Port Specifications .....	30
Table 7: x530L-10GHXm Twisted Pair Ports 1 - 8 LED Functions .....	32
Table 8: x530L-28GTX Twisted Pair Ports 1 - 24 LED Functions .....	34
Table 9: x530L-52GTX Twisted Pair Ports 1 - 48 LED Functions .....	35
Table 10: x530L-28GPX Twisted Pair Ports 1 - 24 LED Functions .....	36
Table 11: x530L-52GPX Twisted Pair Ports 1 - 48 LED Functions .....	37
Table 12: IEEE Powered Device Classes .....	40
Table 13: Link and Activity Status LEDs for the 1Gbps and 10Gbps Ports .....	44
Table 14: Software and Hardware Releases .....	52
Table 15: Default (10Gbps) and Optional (5Gbps) Trunk Ports .....	56
Table 16: Stacking Worksheet .....	79
Table 17: Stacking Worksheet Columns .....	80
Table 18: Adding Ports 25 and 26 to the Stack Trunk on the x530L-28GPX or x530L-28GTX Switch .....	146
Table 19: Adding Ports 49 and 50 to the Stack Trunk on the x530L-52GPX or x530L-52GTX Switch .....	148
Table 20: Configuring the Master x530L-10GHXm Switch for 5Gbps Stacking Ports – Part I .....	159
Table 21: Configuring the Master x530L-10GHXm Switch for 5Gbps Stacking Ports – Part II .....	162
Table 22: Verifying the Master x530L-10GHXm Switch .....	164
Table 23: Configuring Member Switches – Part I .....	169
Table 24: Configuring Member Switches – Part II .....	172
Table 25: Verifying Member Switches .....	173
Table 26: Product Dimensions .....	192
Table 27: Product Weights .....	194
Table 28: Ventilation Requirements .....	194
Table 29: Environmental Specifications .....	195
Table 30: Maximum Power Consumption .....	196
Table 31: Input Voltage .....	196
Table 32: Heat Dissipation .....	197
Table 33: Product Certifications .....	198
Table 34: Pin Signals at 10M/100M .....	199
Table 35: Pin Signals at 1Gbps .....	200
Table 36: RJ-45 Style Serial Console Port Pin Signals .....	201
Table 37: USB Port Pin Signals .....	202





# Preface

---

This guide contains the installation instructions for the x530L Series of stackable Gigabit, Layer 3+ Ethernet switches. This preface contains the following sections:

- “Document Conventions” on page 14
- “Contacting Allied Telesis” on page 15

---

**Note**

This guide explains how to install switches as a stack with Virtual Chassis Stacking (VCStack™). For instructions on how to install the devices as stand-alone switches, refer to the *x530L Series Installation Guide for Stand-alone Switches*.

---

## Document Conventions

---

This document uses the following conventions:

---

**Note**

Notes provide additional information.

---



---

**Caution**

Cautions inform you that performing or omitting a specific action may result in equipment damage or loss of data.

---



---

**Warning**

Warnings inform you that performing or omitting a specific action may result in bodily injury.

---

## Contacting Allied Telesis

---

If you need assistance with this product, you may contact Allied Telesis technical support by going to the Services & Support section of the Allied Telesis web site at **[www.alliedtelesis.com/support](http://www.alliedtelesis.com/support)**. You can find links for the following services on this page:

- ❑ Helpdesk (Support Portal) - Log onto Allied Telesis interactive support center to search for answers to your questions in our knowledge database, check support tickets, learn about Return Merchandise Authorizations (RMAs), and contact Allied Telesis technical experts.
- ❑ Software Downloads - Download the latest software releases for your product.
- ❑ Licensing - Register and obtain your License key to activate your product.
- ❑ Product Documents - View the most recent installation guides, user guides, software release notes, white papers and data sheets for your product.
- ❑ Warranty - View a list of products to see if Allied Telesis warranty applies to the product you purchased and register your warranty.
- ❑ Allied Telesis Helpdesk - Contact a support representative.

To contact a sales representative or find Allied Telesis office locations, go to **[www.alliedtelesis.com/contact](http://www.alliedtelesis.com/contact)**.



# Chapter 1

# Overview

---

This chapter contains the following sections:

- “Front and Rear Panels” on page 18
- “Management Panel” on page 21
- “Features” on page 22
- “Twisted Pair Ports” on page 27
- “Power Over Ethernet” on page 42
- “SFP+ Transceiver Ports” on page 46
- “eco-friendly Button” on page 48
- “VCStack Feature” on page 49
- “Switch ID LED” on page 50
- “USB Port” on page 52
- “Console Port” on page 53
- “Power Supply” on page 54
- “Software and Hardware Releases” on page 55

---

### **Note**

This guide explains how to install switches as a stack with Virtual Chassis Stacking (VCStack™). For instructions on how to install the devices as stand-alone switches, refer to the *x530L Series Installation Guide for Stand-alone Switches*.

---

## Front and Rear Panels

The front panels on the x530L Series switches are shown in Figure 1 through Figure 6 on page 19.

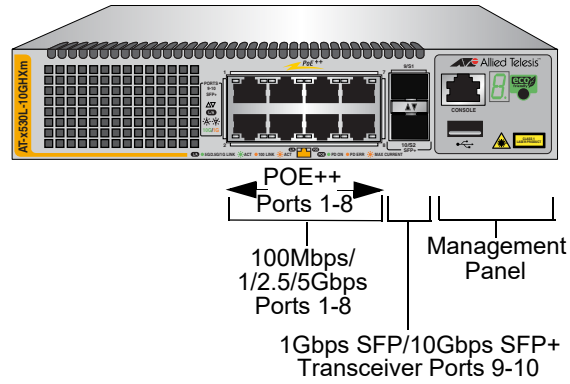

Figure 1. x530L-10GHXm Front Panel

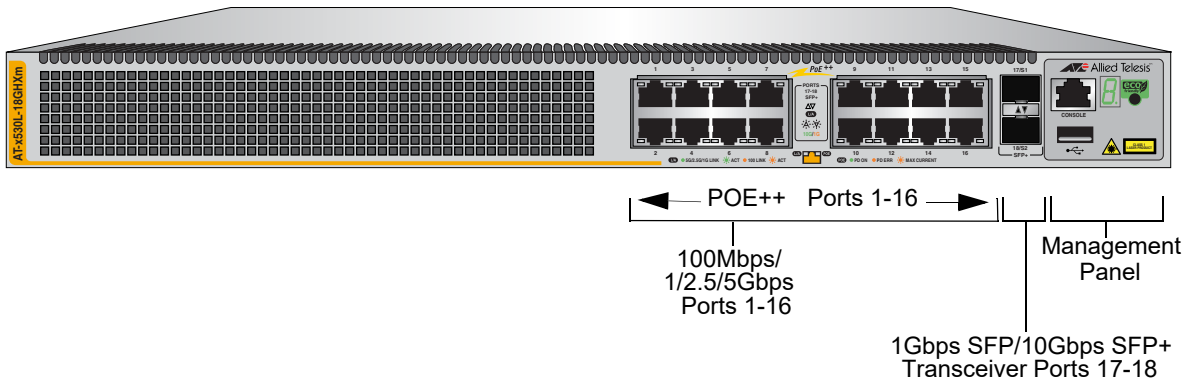

Figure 2. x530L-18GHXm Front Panel

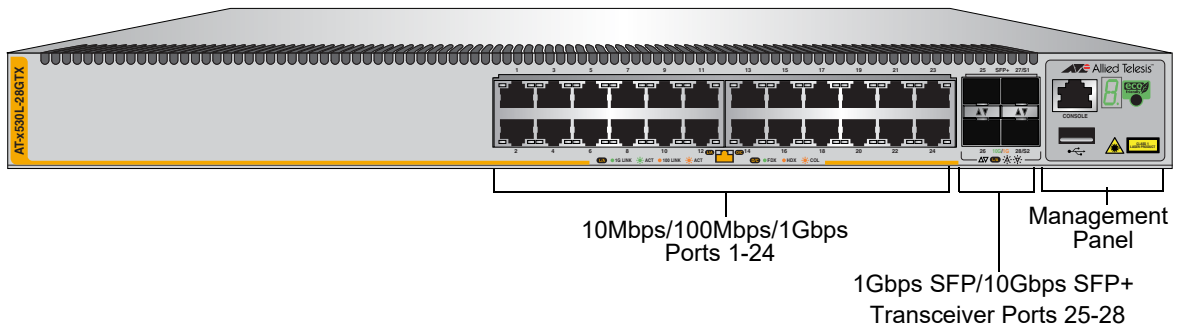

Figure 3. x530L-28GTX Front Panel



The back panels on the x530L Series switches are shown in Figure 7 through Figure 10 on page 20.

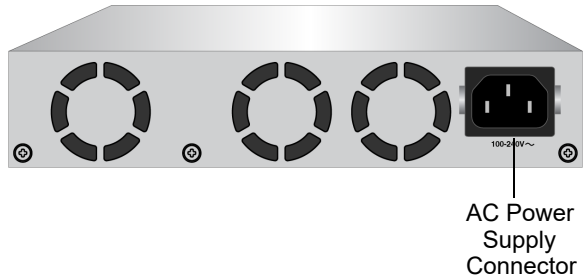

Figure 7. x530L-10GHXm Back Panel

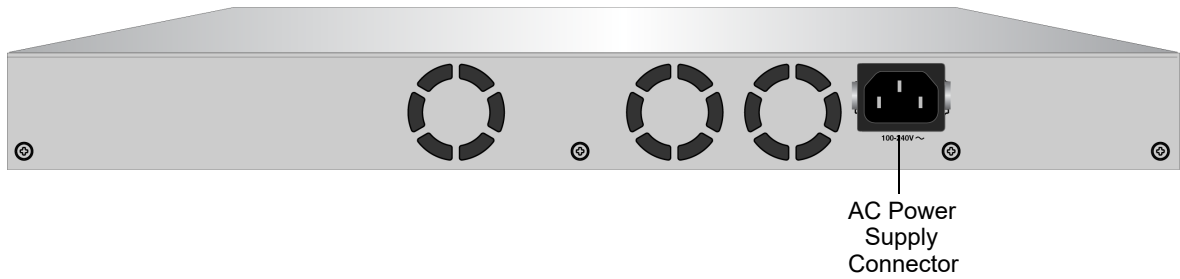

Figure 8. x530L-18GHXm Back Panel

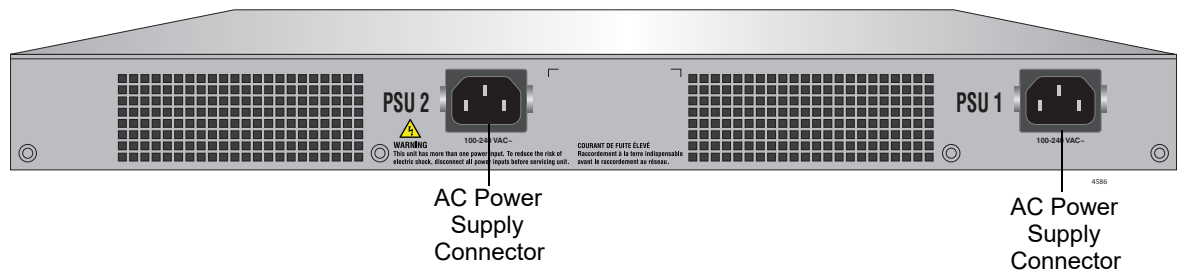

Figure 9. x530L-52GPX and x530L-28GPX Back Panel

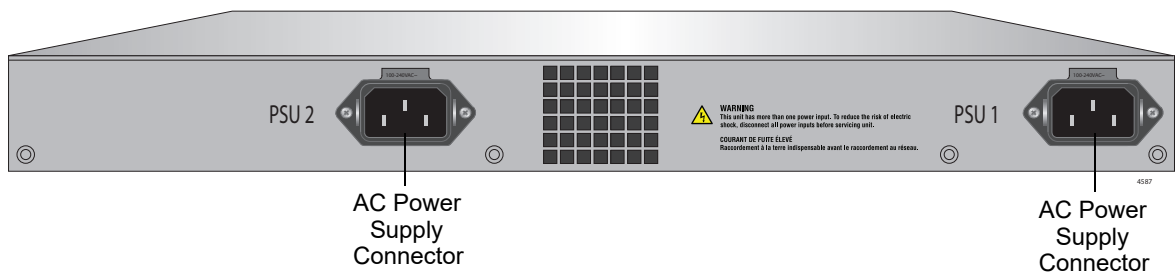

Figure 10. x530L-52GTX and x530L-28GTX Back Panel



## Management Panel

---

Figure 11 identifies the components on the management panel.

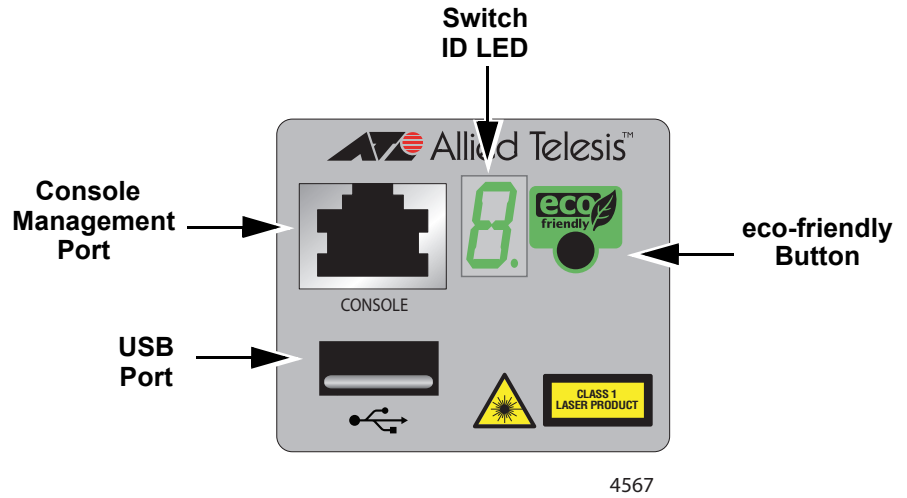

Figure 11. Management Panel

## Features

The Allied Telesis x530L Series switches are stackable Gigabit, Layer 3+ Ethernet switches. The following sections list the features.

**x530L Models** Table 1 lists the basic features for the switch models.

Table 1. Basic Features

Feature	x530L-10GHXm (PoE++)	x530L-18GHXm (PoE++)	x530L-28GTX	x530L-28GPX (PoE+)	x530L-52GTX	x530L-52GPX (PoE+)
100Mbps and 1/2.5/5 Gbps PoE++ Twisted Pair Ports	8	16	-	-	-	-
10Mbps, 100Mbps and 1 Gbps Twisted Pair Ports	-	-	24	-	48	-
10Mbps, 100Mbps and 1 Gbps PoE+ Twisted Pair Ports	-	-	-	24	-	48
1Gbps SFP and 10Gbps SFP+ Transceiver Ports	2	2	4	4	4	4
VCStack	Up to 8	Up to 8	Up to 8	Up to 8	Up to 8	Up to 8
Pre-installed Power Supply (Not field replaceable)	1	1	2	2	2	2

**Twisted Pair Ports** The twisted pair ports on the x530L-10GHXm (1 to 8) and x530L-18GHXm (1 to 16) switches have the following features:

- Supports 100Mbps and 1/2.5/5Gbps operation
- 100 meters (328 feet) maximum operating distance per port
- Auto-Negotiation for speed
- Half-duplex mode at 100Mbps
- Full-duplex mode at 100Mbps and 1/2.5/5Gbps
- Auto-MDI/MDI-X at 100Mbps and 1/2.5/5Gbps
- Port Link/Activity (L/A) and Duplex/Collision (D/C) LEDs

The twisted pair ports on the AT-x530L-28GTX (1 to 24) and AT-x530L-52GTX (1 to 48) switches have these features:

- Supports 10Mbps, 100Mbps and 1 Gbps operation
- 100 meters (328 feet) maximum operating distance per port
- Auto-Negotiation for speed

- ❑ Half-duplex mode at 10/100Mbps
- ❑ Full-duplex mode at 10/100/1000Mbps
- ❑ Auto-MDI/MDI-X at 10/100/1000Mbps
- ❑ Port Link/Activity (L/A) and Duplex/Collision (D/C) LEDs

The twisted pair ports on the AT-x530L-28GPX (1 to 24) switch have these features:

- ❑ Ports 1 to 20 support 10Mbps, 100Mbps and 1 Gbps operation
- ❑ Ports 21 to 24 support 100Mbps and 1/2.5/5Gbps operation
- ❑ 100 meters (328 feet) maximum operating distance per port
- ❑ Auto-Negotiation for speed
- ❑ Full-duplex mode only
- ❑ MDI/MDI-X at 10Mbps/100Mbps
- ❑ Power over Ethernet (PoE+) supported on all 24 ports
- ❑ Port Link/Activity (L/A) and Power over Ethernet (PoE) LEDs

The twisted pair ports on the AT-x530L-52GPX (1 to 48) switch have these features:

- ❑ Ports 1 to 40 support 10/100Mbps and 1 Gbps operation
- ❑ Ports 41 to 48 support 100Mbps and 1/2.5/5Gbps operation
- ❑ 100 meters (328 feet) maximum operating distance per port
- ❑ Auto-Negotiation for speed
- ❑ Full-duplex mode only
- ❑ MDI/MDI-X at 10/100Mbps
- ❑ Power over Ethernet (PoE+) supported on all 48 ports
- ❑ Port Link/Activity (L/A) and Power over Ethernet (PoE) LEDs

## **Power Over Ethernet**

The basic features of PoE++ on the twisted pair ports on the x530L-28GPX and x530L-52GPX switches are:

- ❑ Supported on all ports
- ❑ 740W maximum power budget (370W per power supply):
  - PoE (15.4 watts maximum) for 24 and 48 powered devices on the x530L-28GPX and x530L-52GPX switches, respectively
  - PoE+ (30 watts maximum) for 24 powered devices on the x530L-28GPX and x530L-52GPX switches
- ❑ Supports powered device classes 0 to 4

- ❑ Port prioritization
- ❑ Mode wiring:
  - Classes 0-4 (Type 1 or 2 up to 30W): Mode A (MDI-x)
  - Classes 5-6 (Type 3 up to 45W/60W): Mode A (MDI-x) plus Mode B (MDI-x, MDI)
  - Classes 7-8 (Type 4 up to 75W/90W): Mode A (MDI-x) plus Mode B (MDI-x, MDI)
- ❑ IEEE802.3af/at compliant

The basic features of PoE++ on the twisted pair ports on the x530L-10GHXm switch are:

- ❑ Supported on all ports
- ❑ 500W maximum power budget:
  - PoE (15.4 watts maximum) for 8 powered devices
  - PoE+ (30 watts maximum) for 8 powered devices
  - PoE++ (60 watts maximum) for 8 powered devices
  - PoE++ (90 watts maximum) for 5 powered devices
- ❑ Supports powered device classes 0 to 8
- ❑ Port prioritization
- ❑ Mode wiring:
  - Classes 0-4 (Type 1 or 2 up to 30W): Mode A (MDI-x)
  - Classes 5-6 (Type 3 up to 45W/60W): Mode A (MDI-x) plus Mode B (MDI-x, MDI)
  - Classes 7-8 (Type 4 up to 75W/90W): Mode A (MDI-x) plus Mode B (MDI-x, MDI)
- ❑ IEEE802.3af/at/bt compliant

The basic features of PoE on the twisted pair ports on the x530L-18GHXm switch are:

- ❑ Supported on all ports
- ❑ 720 maximum power budget:
  - PoE (15.4 watts maximum) for 16 powered devices
  - PoE+ (30 watts maximum) for 16 powered devices
  - PoE++ (60 watts maximum) for 12 powered devices
  - PoE++ (90 watts maximum) for 8 powered devices
- ❑ Supports powered device classes 0 to 8
- ❑ Port prioritization

- ❑ Mode wiring:
  - Classes 0-4 (Type 1 or 2 up to 30W): Mode A (MDI-x)
  - Classes 5-6 (Type 3 up to 45W/60W): Mode A (MDI-x) plus Mode B (MDI-x, MDI)
  - Classes 7-8 (Type 4 up to 75W/90W): Mode A (MDI-x) plus Mode B (MDI-x, MDI)
- ❑ IEEE802.3af/at/bt compliant

## SFP+ Transceiver Ports

Examples of SFP 1Gbps transceivers include:

- ❑ SPSX and LR short and long distance transceivers using multi-mode or single mode fiber optic cable.
- ❑ SPEX transceivers with a maximum distance of two kilometers with multi-mode fiber optic cable.
- ❑ SP10BD bidirectional transceivers for single mode fiber optic cable with a maximum distance of 10 kilometers.

Examples of SFP+ 10Gbps transceivers include:

- ❑ SP10SR, LR, ER and ZR series of short or long distance transceivers using multi-mode or single mode fiber optic cable.
- ❑ SP10TW series of direct attach cables in lengths of 1 meter and 3 meters.
- ❑ SP10T transceiver with RJ-45 connector for links up to 20 meters at 10Gbps with Category 6a or better twisted pair cable, or 100 meters at 1Gbps.
- ❑ SP10LRM Long Reach Multimode transceiver for OM1 multi-mode fiber optic links up to 220 meters.

---

### Note

Industrial (-40 to 85° C) and extended (-40 to 105° C) temperature transceivers are available.

---



---

### Note

SFP and SFP+ transceivers must be purchased separately. For a current list of supported transceiver modules refer to the *x530L Series Data Sheet*

---

The following restrictions on SFP+ transceivers apply:

- ❑ 100Mbps transceivers are not supported
- ❑ Supports full-duplex mode only

## **LEDs**

The port LEDs are:

- Link/activity LEDs for the twisted pair ports
- Link/activity LEDs for the SFP and SFP+ transceiver ports
- PoE+ LEDs for the twisted pair ports on the x530L-28GPX and x530L-52GPX switches
- PoE++ LEDs for the twisted pair ports on the x530L-10GHXm and x530L-18GHXm switches
- Full/Half/Collision LEDs for the twisted pair ports on the x530L-28GTX and x530L-52GTX switches
- Switch ID number LED

## **Installation Options**

The installation options are:

- Desk or tabletop
- 19-inch equipment rack
- Wood or concrete wall

## **Management Software and Interfaces**

The management software and interfaces are:

- AlliedWare Plus Management Software
- Command line interface (CLI)

## **Management Methods**

The following methods are used for managing the switches:

- Local management through the Console port
- Remote Telnet or Secure Shell management
- Vista Manager mini
- Autonomous Management Framework (AMF) with Vista Manager EX
- Autonomous Wave Control for wireless networks
- SNMPv1, v2c, and v3

## Twisted Pair Ports

The specifications of the twisted pair ports are listed in Table 2 through Table 7 on page 32.

Table 2. x530L-10GHXm Switch Twisted Pair Port Specifications

Specification	Description
Port Speed	Ports 1 - 8: 100Mbps or 1/2.5/5Gbps. 100Mbps: Set the port speed manually or with Auto-Negotiation. 1/2.5/5Gbps: The port speed is set with Auto-Negotiation only. The default is Auto-Negotiation for all ports.
Duplex Mode	Ports 1 - 8: 100Mbps: Full- or half-duplex mode. 1/2.5/5Gbps: Full-duplex mode only. Supports Auto-Negotiation at 100Mbps.
Maximum Distance	100 meters (328 feet)
Power over Ethernet	<input type="checkbox"/> PoE (15.4W maximum per port) / 8 PDs <input type="checkbox"/> PoE+ (30W maximum per port) / 8 PDs <input type="checkbox"/> PoE++(60W maximum per port) / 8 PDs <input type="checkbox"/> PoE++(90W maximum per port) / 5 PDs
Maximum Power Budget	500W
PoE Mode	<input type="checkbox"/> Classes 0-4 (Type 1 or 2 up to 30W): Mode A (MDI-x) <input type="checkbox"/> Classes 5-6 (Type 3 up to 45W/60W): Mode A (MDI-x) plus Mode B (MDI-x, MDI) <input type="checkbox"/> Classes 7-8 (Type 4 up to 75W/90W): Mode A (MDI-x) plus Mode B (MDI-x, MDI)
Connector	8-pin RJ-45

Table 3. x530L-18GHXm Switch Twisted Pair Port Specifications

Specification	Description
Port Speed	Ports 1 - 16: 100Mbps or 1/2.5/5Gbps. 100Mbps: Set the port speed manually or with Auto-Negotiation. 1/2.5/5Gbps: The port speed is set with Auto-Negotiation only. The default is Auto-Negotiation for all ports.
Duplex Mode	Ports 1 - 16: 100Mbps: Full- or half-duplex mode. 1/2.5/5Gbps: Full-duplex mode only. Supports Auto-Negotiation at 100Mbps.
Maximum Distance	100 meters (328 feet)
Power over Ethernet	<input type="checkbox"/> PoE (15.4W maximum per port) / 16 PDs <input type="checkbox"/> PoE+ (30W maximum per port) / 16 PDs <input type="checkbox"/> PoE++ (60W maximum per port) / 12 PDs <input type="checkbox"/> PoE++ (90W maximum per port) / 8 PDs
Maximum Power Budget	720W
PoE Mode	<input type="checkbox"/> Classes 0-4 (Type 1 or 2 up to 30W): Mode A (MDI-x) <input type="checkbox"/> Classes 5-6 (Type 3 up to 45W/60W): Mode A (MDI-x) plus Mode B (MDI-x, MDI) <input type="checkbox"/> Classes 7-8 (Type 4 up to 75W/90W): Mode A (MDI-x) plus Mode B (MDI-x, MDI)
Connector	8-pin RJ-45



Table 4. x530L-28GTX Switch Twisted Pair Port Specifications

<b>Specification</b>	<b>Description</b>
Port Speed	Ports 1 - 24: 10Mbps, 100Mbps or 1 Gbps. 10Mbps/100Mbps: Set the port speed manually or with Auto-Negotiation. 1Gbps: The port speed is set with Auto-Negotiation only. The default is Auto-Negotiation for all ports.
Duplex Mode	Ports 1 - 24: 10Mbps/100Mbps: Full- or half-duplex mode. 1Gbps: Full-duplex mode only. Supports Auto-Negotiation at 10Mbps and 100Mbps.
Maximum Distance	100 meters (328 feet).
Connector	8-pin RJ-45.

Table 5. x530L-28GPX Switch Twisted Pair Port Specifications

Specification	Description
Port Speed	Ports 1 - 24: 10Mbps, 100Mbps or 1Gbps. 10Mbps/100Mbps: Set the port speed manually or with Auto-Negotiation. 1Gbps: The port speed is set with Auto-Negotiation only. The default is Auto-Negotiation for all ports.
Duplex Mode	Ports 1 - 24: 10Mbps/100Mbps: Full- or half-duplex mode. 1Gbps: Full-duplex mode only. Supports Auto-Negotiation at 10Mbps and 100Mbps.
Maximum Distance	100 meters (328 feet).
Power over Ethernet	PoE (15.4W maximum per port) and PoE+ (30W maximum per port).
Maximum Power Budget	740W (370W per power supply).
PoE Mode	Classes 0 to 4: Mode A
Connector	8-pin RJ-45.

Table 6. x530L-52GTX Switch Twisted Pair Port Specifications

<b>Specification</b>	<b>Description</b>
Port Speed	Ports 1 - 48: 10Mbps, 100Mbps or 1Gbps. 10Mbps/100Mbps: Set the port speed manually or with Auto-Negotiation. 1Gbps: The port speed is set with Auto-Negotiation only. The default is Auto-Negotiation for all ports.
Duplex Mode	Ports 1 - 48: 10Mbps/100Mbps: Full- or half-duplex mode. 1Gbps: Full-duplex mode only. Supports Auto-Negotiation at 10Mbps and 100Mbps.
Maximum Distance	100 meters (328 feet).
Connector	8-pin RJ-45.

Table 7. x530L-52GPX Switch Twisted Pair Port Specifications

Specification	Description
Port Speed	Ports 1 - 48: 10Mbps, 100Mbps or 1Gbps. 10Mbps/100Mbps: Set the port speed manually or with Auto-Negotiation. 1Gbps: The port speed is set with Auto-Negotiation only. The default is Auto-Negotiation for all ports.
Duplex Mode	Ports 1 - 48: 10Mbps/100Mbps: Full- or half-duplex mode. 1Gbps: Full-duplex mode only. Supports Auto-Negotiation at 10Mbps and 100Mbps.
Maximum Distance	100 meters (328 feet).
Power over Ethernet	PoE (15.4W maximum per port) and PoE+ (30W maximum per port).
Maximum Power Budget	740W (370W per power supply).
PoE Mode	Classes 0 to 4: Mode A.
Connector	8-pin RJ-45.

## Duplex Mode

The twisted pair ports can operate in either half- or full-duplex mode at 10 Mbps and 100 Mbps and full-duplex only at higher speeds.

The duplex mode of a port operating at 10Mbps or 100Mbps, like port speed, can be set manually using the management software or automatically with Auto-Negotiation (IEEE 802.3u), the default setting.

The speed and duplex mode settings of a port can be set independently of each other. For example in the case of a 10Mbps or 100Mbps port, it can be configured such that its speed is set manually while its duplex mode is established through Auto-Negotiation.

---

**Note**

Switch ports default to half-duplex mode when connected to 10Mbps or 100Mbps network devices that do not support Auto-Negotiation. If a network device supports full-duplex only, a duplex mode mismatch can occur, resulting in poor network performance. To prevent this, disable Auto-Negotiation and set the duplex mode manually on ports connected to 10Mbps or 100Mbps devices that support full-duplex only.

---

**Wiring Configuration**

The wiring configuration of a port operating at 10/100Mbps can be MDI or MDI-X. The wiring configurations of a switch port and a network device connected with straight-through twisted pair cabling must be opposite, such that one device is using MDI and the other MDI-X. For example, a switch port must be set to MDI-X if it is connected to a network device set to MDI.

The wiring configurations of the ports can be set manually or automatically by the switch with auto-MDI/MDI-X (IEEE 802.3ab-compliant). This feature enables the switch to automatically negotiate with network devices to establish their proper settings.

The MDI and MDI-X settings do not apply when ports are operating at a speed of 1Gbps or higher.

**Cable Requirements**

Minimum twisted pair cable requirements are as follows:

- ❑ 10/100Mbps ports: Standard TIA/EIA 568-B-compliant Category 3 unshielded cabling
- ❑ 1Gbps ports: Standard TIA/EIA 568-A-compliant Category 5 or TIA/EIA 568-B-compliant Enhanced Category 5 (Cat 5e)
- ❑ 2.5/5Gbps ports: Standard TIA/EIA 568-A-compliant Category 6 or TIA/EIA 568-B-compliant Category 6A (Cat 6A) unshielded cabling

**Port Pinouts**

Refer to Table 42 on page 224 and Table 43 on page 225 for the pin signals.

**LEDs** Each twisted pair port has two LEDs that display the port status.

**x530L-10GHXm**

The LEDs indicate Link/Activity (L/A) and PoE (PD ON/PD ERR/MAX CURRENT) information. These LEDs are shown in Figure 12.

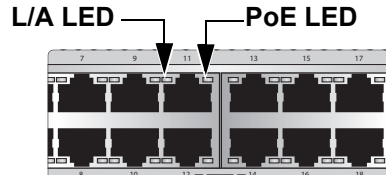

Figure 12. x530L-10GHXm Twisted Pair Ports

The states of the x530L-10GHXm LEDs are described in Table 8.

Table 8. x530L-10GHXm Twisted Pair Ports 1 - 8 LED Functions

LED	Ports	State	Description
L/A	1 - 8	Solid Green	The port has established a 1/2.5/5Gbps link to a network device.
		Flashing Green	The port is transmitting or receiving data at 1/2.5/5Gbps.
		Solid Amber	The port has established a 100Mbps link to a network device.
		Flashing Amber	The port is transmitting or receiving data at 100 Mbps.
		Off	Possible causes of this state are: - The port has not established a link with another network device. - The LEDs are turned off. To turn on the LEDs, use the eco-friendly button.

Table 8. x530L-10GHXm Twisted Pair Ports 1 - 8 LED Functions (Continued)

LED	Ports	State	Description
PoE	1-8	Solid Green	PD On - The switch is delivering power to a powered device connected to the port.
		Solid Amber	PD Error - The switch has shut down PoE on the port because of a fault condition.
		Flashing Amber	PD Max Current - The switch has detected a powered device on the port but is not delivering power to it because doing so would exceed its available power budget.
		Off	No PD - This LED state can result from the following conditions: <ul style="list-style-type: none"> <li>- The port is not connected to a powered device or the device is powered off.</li> <li>- The port is disabled in the management software.</li> <li>- PoE is disabled on the port.</li> <li>- The LEDs are turned off. To turn on the LEDs, use the eco-friendly button.</li> </ul>

**x530L-18GHXm**

The LEDs indicate Link/Activity (L/A) and PoE (PD ON/PD ERR/MAX CURRENT) information. These LEDs are shown in Figure 13.

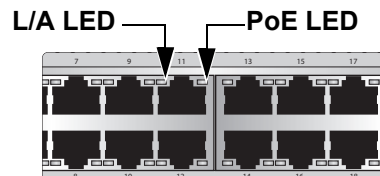

Figure 13. x530L-18GHXm Twisted Pair Ports

The states of the x530L-18GHXm LEDs are described in Table 9.

Table 9. x530L-18GHXm Twisted Pair Ports 1 - 16 LED Functions

LED	Ports	State	Description
L/A	1 - 16	Solid Green	The port has established a 1/2.5/5Gbps link to a network device.
		Flashing Green	The port is transmitting or receiving data at 1/2.5/5Gbps.
		Solid Amber	The port has established a 100Mbps link to a network device.
		Flashing Amber	The port is transmitting or receiving data at 100 Mbps.
		Off	<p>Possible causes of this state are:</p> <ul style="list-style-type: none"> <li>- The port has not established a link with another network device.</li> <li>- The LEDs are turned off. To turn on the LEDs, use the eco-friendly button.</li> </ul>
PoE	1-16	Solid Green	PD On - The switch is delivering power to a powered device connected to the port.
		Solid Amber	PD Error - The switch has shut down PoE on the port because of a fault condition.
		Flashing Amber	PD Max Current - The switch has detected a powered device on the port but is not delivering power to it because doing so would exceed its available power budget.
		Off	<p>No PD - This LED state can result from the following conditions:</p> <ul style="list-style-type: none"> <li>- The port is not connected to a powered device or the device is powered off.</li> <li>- The port is disabled in the management software.</li> <li>- PoE is disabled on the port.</li> <li>- The LEDs are turned off. To turn on the LEDs, use the eco-friendly button.</li> </ul>



**x530L-28GTX**

The LEDs indicate Link/Activity (L/A) and Duplex/Collision (FDX/HDX/ COL) information. These LEDs are shown in Figure 14.

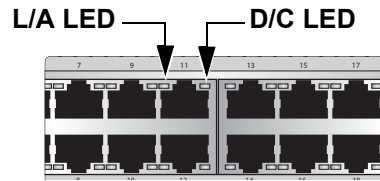

Figure 14. x530L-28GTX Twisted Pair Port LEDs

The states of the x530L-28GTX LEDs are described in Table 10.

Table 10. x530L-28GTX Twisted Pair Ports 1 - 24 LED Functions

LED	Ports	State	Description
L/A	1 - 24	Solid Green	The port has established a 1Gbps link to a network device.
		Flashing Green	The port is transmitting or receiving data at 1Gbps.
		Solid Amber	The port has established a 10Mbps or 100 Mbps link to a network device.
		Flashing Amber	The port is transmitting or receiving data at 10Mbps or 100Mbps.
		Off	Possible causes of this state are: - The port has not established a link with another network device. - The LEDs are turned off. To turn on the LEDs, use the eco-friendly button.
D/C	1 - 24	Solid Green	The port is operating in full-duplex mode.
		Solid Amber	The port is operating in half-duplex mode.
		Flashing Amber	The port is operating in half-duplex mode with collisions.

### x530L-52GTX

The LEDs indicate Link/Activity (L/A) and Duplex/Collision (FDX/HDX/ COL) information. These LEDs are shown in Figure 15.

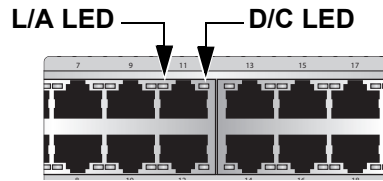

Figure 15. x530L-52GTX Twisted Pair Port LEDs

The states of the x530L-52GTX LEDs are described in Table 11.

Table 11. x530L-52GTX Twisted Pair Ports 1 - 48 LED Functions

LED	Ports	State	Description
L/A	1 - 48	Solid Green	The port has established a 1Gbps link to a network device.
		Flashing Green	The port is transmitting or receiving data at 1Gbps.
		Solid Amber	The port has established a 10Mbps or 100 Mbps link to a network device.
		Flashing Amber	The port is transmitting or receiving data at 10Mbps or 100Mbps.
		Off	Possible causes of this state are: - The port has not established a link with another network device. - The LEDs are turned off. To turn on the LEDs, use the eco-friendly button.
D/C	1 - 48	Solid Green	The port is operating in full-duplex mode.
		Solid Amber	The port is operating in half-duplex mode.
		Flashing Amber	The port is operating in half-duplex mode with collisions.

**x530L-28GPX**

The LEDs indicate Link/Activity (L/A) and PoE (PD ON/PD ERR/MAX CURRENT) information. These LEDs are shown in Figure 16.

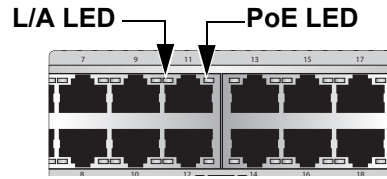

Figure 16. x530L-28GPX Twisted Pair Ports

The states of the x530L-28GTX LEDs are described in Table 12.

Table 12. x530L-28GPX Twisted Pair Ports 1 - 24 LED Functions

LED	Ports	State	Description
L/A	1 - 24	Solid Green	The port has established a 1Gbps link to a network device.
		Flashing Green	The port is transmitting or receiving data at 1Gbps.
		Solid Amber	The port has established a 10Mbps or 100Mbps link to a network device.
		Flashing Amber	The port is transmitting or receiving data at 10Mbps or 100 Mbps.
		Off	Possible causes of this state are: - The port has not established a link with another network device. - The LEDs are turned off. To turn on the LEDs, use the eco-friendly button.

Table 12. x530L-28GPX Twisted Pair Ports 1 - 24 LED Functions (Continued)

LED	Ports	State	Description
PoE	1 - 24	Solid Green	PD On - The switch is delivering power to a powered device connected to the port.
		Solid Amber	PD Error - The switch has shut down PoE on the port because of a fault condition.
		Flashing Amber	PD Max Current - The switch has detected a powered device on the port but is not delivering power to it because doing so would exceed its available power budget.
		Off	No PD - This LED state can result from the following conditions: <ul style="list-style-type: none"> <li>- The port is not connected to a powered device or the device is powered off.</li> <li>- The port is disabled in the management software.</li> <li>- PoE is disabled on the port.</li> <li>- The LEDs are turned off. To turn on the LEDs, use the eco-friendly button.</li> </ul>

**x530L-52GPX**

The LEDs indicate Link/Activity (L/A) and PoE (PD ON/PD ERR/MAX CURRENT) information. These LEDs are shown in Figure 17.

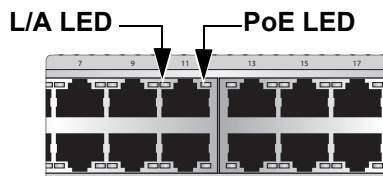

Figure 17. x530L-52GPX Twisted Pair Ports

The states of the x530L-52GPX LEDs are described in Table 13 on page 41.

Table 13. x530L-52GPX Twisted Pair Ports 1 - 48 LED Functions

LED	Ports	State	Description
L/A	1 - 48	Solid Green	The port has established a 1Gbps link to a network device.
		Flashing Green	The port is transmitting or receiving data at 1Gbps.
		Solid Amber	The port has established a 10Mbps or 100Mbps link to a network device.
		Flashing Amber	The port is transmitting or receiving data at 10Mbps or 100 Mbps.
		Off	Possible causes of this state are: <ul style="list-style-type: none"> <li>- The port has not established a link with another network device.</li> <li>- The LEDs are turned off. To turn on the LEDs, use the eco-friendly button.</li> </ul>
PoE	1 - 48	Solid Green	PD On - The switch is delivering power to a powered device connected to the port.
		Solid Amber	PD Error - The switch has shut down PoE on the port because of a fault condition.
		Flashing Amber	PD Max Current - The switch has detected a powered device on the port but is not delivering power to it because doing so would exceed its available power budget.
		OFF	No PD - This LED state can result from the following conditions: <ul style="list-style-type: none"> <li>- The port is not connected to a powered device or the device is powered off.</li> <li>- The port is disabled in the management software.</li> <li>- PoE is disabled on the port.</li> <li>- The LEDs are turned off. To turn on the LEDs, use the eco-friendly button.</li> </ul>

## Power Over Ethernet

---

The x530L-10GHXm, x530L-18GHXm, x530L-28GPX, and x530L-52GPX switches feature PoE on twisted pair ports. With PoE, the switch supplies DC power to network devices over the same twisted pair cables that carry the network traffic.

PoE can make it easier to install networks. The selection of a location for a network device can be limited by whether there is a power source nearby. This often limits equipment placement or requires the added time and cost of having additional electrical sources installed. With PoE, you can install PoE-compatible devices wherever they are needed without having to worry about whether there are power sources nearby.

A device that provides PoE to network devices is referred to as *power sourcing equipment* (PSE). It functions as a central power source for other network devices.

Devices that receive their power from a PSE are called *powered devices* (PD). Examples include wireless access points, IP telephones, webcams, and even other Ethernet switches.

The x530L-10GHXm, x530L-18GHXm, x530L-28GPX, and x530L-52GPX switches automatically determine whether devices connected to their ports are powered devices. Ports that are connected to network nodes that are not powered devices (that is, devices that receive their power from another power source) function as regular Ethernet ports, without PoE. The PoE feature remains activated on the ports but no power is delivered to the devices.

### PoE Standards

The x530L-28GPX, x530L-52GPX, x530L-18GHXm, and x530L-10GHXm switches support these PoE standards:

- ❑ PoE (IEEE 802.3af): This standard provides up to 15.4 watts at the switch port for powered devices that require up to 13.0 watts.
- ❑ PoE+ (IEEE 802.3at): This standard provides up to 30.0 watts at the switch port for powered devices that require up to 25.5 watts.

The x530L-18GHXm and x530L-10GHXm switches support this additional PoE standard:

- ❑ PoE++ (IEEE 802.3bt): This standard provides up to 90.0 watts at the switch ports for powered devices that require up to 71.0 watts.

## Powered Device Classes

Powered devices are grouped into the nine classes listed in Table 14. The classes are based on the amount of power the devices require. The x530L-28GPX and x530L-52GPX switches support classes 0 to 4. The x530L-10GHXm and x530L-18GHXm switches support classes 0 to 8.

Table 14. IEEE Powered Device Classes

Class	Maximum Power Output from a Switch Port	PD Power Range
0	15.4W	0.44W to 12.94W
1	4.0W	0.44W to 3.84W
2	7.0W	3.84W to 6.49W
3	15.4W	6.49W to 12.94W
4	30.0W	12.94W to 25.5W
5	45.0W	40.0W (4-pair)
6	60.0W	51.3W (4-pair)
7	75.0W	62.0W (4-pair)
8	90.0W	71.3W (4-pair)



### Caution

When hot-swapping PoE PD Classes 5-8, the IC device can be damaged when the Ethernet cable is removed while supplying PoE power. To avoid damage, disable the port with the CLI or power off the unit before removing the cable. **E133**

## Power Budget

The x530L-28GPX and x530L-52GPX switches have two power supplies. Each power supply provides 370W for a total PoE of 740W. This is the total maximum amount of power that the switch can supply to powered devices on the 24/48 PoE+ twisted pair ports. The number of powered devices that the switches can support at one time will depend on their power requirements. For instance, under normal operating conditions, the switches can support up to 24 Class 4 powered devices with the maximum 25.5W.

The x530L-10GHXm switch has one power supply. It can supply 500W of PoE power. This is the total maximum amount of power that the switch can supply to powered devices on the eight PoE++ twisted pair ports. The number of powered devices that the switch can support at one time will depend on their power requirements. For instance, under normal operating

conditions, the switch can support up to eight Class 6 powered devices with the maximum 51.35W or up to five Class 8 powered devices with the maximum of 71.3W.

The x530L-18GHXm switch has one power supply. It can supply 720W of PoE power. This is the total maximum amount of power that the switch can supply to powered devices on the sixteen PoE++ twisted pair ports. The number of powered devices that the switch can support at one time will depend on their power requirements. For instance, under normal operating conditions, the switch can support up to twelve Class 6 powered devices with the maximum 51.3W or up to seven Class 8 powered devices with the maximum of 71.3W.

## **Port Prioritization**

The power requirements of the PoE devices determine the maximum number of devices the switch can support at one time. So long as the total power requirements of the power devices is less than the power budget of the switch, the switch can supply power to all the devices. But if the total power requirements exceed the power budget, the switch denies power to one or more ports using a mechanism referred to as port prioritization.

To determine whether the power requirements of the PoE devices you plan to connect to the switch exceed its power budget, refer to their documentation for their power requirements and add the requirements together. The switch should be able to power all the devices simultaneously as long as the total is below its power budget. If the total exceeds the available power budget, you should consider reducing the number of PoE devices so that all of the devices receive power. Otherwise, the switch powers a subset of the devices, based on port prioritization.

There are three priority levels:

- Critical
- High
- Low

Ports set to the Critical level, the highest priority level, are guaranteed power before any of the ports assigned to the other two priority levels. Ports assigned to the other priority levels receive power only if all the Critical ports are receiving power. Ports that are connected to your most critical powered devices must be assigned to this level. If there is not enough power to support all the ports set to the Critical priority level, power is provided to the ports based on port number, in ascending order.

The High level is the second highest level. Ports set to this level receive power only if all the ports set to the Critical level are already receiving power. If there is not enough power to support all of the ports set to the High priority level, power is provided to the ports based on port number, in ascending order.



The lowest priority level is Low. This is the default setting. Ports set to this level only receive power if all of the ports assigned to the other two levels are already receiving power. As with the other levels, if there is not enough power to support all of the ports set to the Low priority level, power is provided to the ports based on port number, in ascending order.

Power allocation is dynamic. Ports supplying power to powered devices can cease power transmission if the switch power budget is at maximum usage and new powered devices, connected to ports with higher priorities become active.

## Wiring Implementation

The IEEE 802.3af standard defines two methods for delivering DC power over twisted pair cable by a switch to powered devices. These methods are known as Modes A and B, and identify the individual wires that carry the DC power within the cable from the switch to powered devices.

Twisted pair cabling typically consists of eight wires. With 100Base-TX devices, the wires connected to pins 1, 2, 3, and 6 on the RJ-45 connectors carry the network traffic while the wires connected to pins 4, 5, 7, and 8 are unused. At higher speeds, all eight wires are used to carry network data.

It takes four wires to deliver DC power to a powered device. With Mode A, power is delivered on pins 1, 2, 3, and 6. These are the same pins in 10Base-T and 100Base-TX devices that carry the network data. With Mode B, power is provided over the spare wires.

The x530L-28GPX and x530L-52GPX switches support powered device Classes 0 to 4 up to 30W, using Mode A.

The wiring modes for the x530L-10GHXm and x530L-18GHXm switches are as follows:

- ❑ Classes 0-4 (Type 1 or 2 up to 30W): Mode A (MDI-x)
- ❑ Classes 5-6 (Type 3 up to 45W/60W): Mode A (MDI-x) plus Mode B (MDI-x, MDI)
- ❑ Classes 7-8 (Type 4 up to 75W/90W): Mode A (MDI-x) plus Mode B (MDI-x, MDI)

Powered devices of Classes 0 to 4 that comply with the IEEE 802.3af standard are required to support both Modes A and B. Legacy devices that do not comply with the standard will work with the switch if they are powered on pins 1, 2, 3, and 6.

## SFP+ Transceiver Ports

---

### 1Gbps/10 Gbps SFP or SFP+ Transceivers

The following ports support 1Gbps/10 Gbps SFP or SFP+ transceivers:

- ❑ x530L-10GHXm switch has two ports (ports 9 - 10)
- ❑ x530L-18GHXm switch has two ports (ports 17 - 18)
- ❑ x530L-28GPX and x530L-28GTX switches have four ports (ports 25 - 28)
- ❑ x530L-52GTX and x530L-52GPX switches have four ports (ports 49 - 52)

See “SFP+ Transceiver Ports” on page 25 for a description and guidelines of the SFP+ transceivers.

---

#### Note

SFP or SFP+ transceivers must be purchased separately. For a list of supported transceivers, refer to the product data sheet on the Allied Telesis web site.

---

### LEDs

Each transceiver port has one LED. The LEDs are located between the ports. Refer to Figure 18.

**Top Transceiver Port LED**      **Bottom Transceiver Port LED**

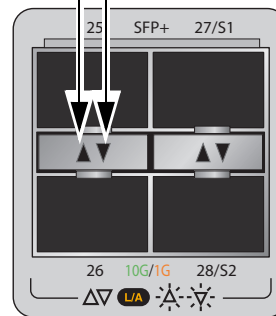

Figure 18. Link and Activity LEDs for the 1Gbps SFP/10Gbps SFP+ Ports

The LEDs display link status and activity. The possible LED states are described in Table 15.

Table 15. Link and Activity Status LEDs for the 1Gbps and 10Gbps Ports

State	Description
Solid Green	The transceiver has established a 10Gbps link to a network device.
Flashing Green	The transceiver is transmitting or receiving data in 10Gbps.
Solid Amber	The transceiver has established a 1Gbps link to a network device.
Flashing Amber	The transceiver is transmitting or receiving data in 1Gbps.
Off	Possible causes of this state are: <ul style="list-style-type: none"> <li>- The port is empty.</li> <li>- The transceiver has not established a link to a network device.</li> <li>- A non-supported module is installed.</li> <li>- The LEDs are turned off. To turn on the LEDs, use the eco-friendly button.</li> </ul>

## eco-friendly Button

---

The eco-friendly button on the front panel of the switch is used to toggle the port LEDs on or off. You can turn off the LEDs to conserve electricity when you are not monitoring the device. You can also toggle the LEDs with the ECOFRIENDLY LED and NO ECOFRIENDLY LED commands in the Global Configuration mode of the command line interface of the AlliedWare Plus management software.

The switch is operating in a low power mode when the LEDs are turned off. Operating the switch in the low power mode does not interfere with the network operations of the device.

The management software on the switch has a command that blinks the LEDs so that you can quickly and easily identify a specific unit among the devices in an equipment rack. It is the FINDME command. The command works on the switch even if you turned off the LEDs with the eco-friendly button or NO ECOFRIENDLY LED command.

---

### **Note**

Before checking or troubleshooting the network connections to the ports on the switch, you must always check to be sure that the LEDs are on by either pressing the eco-friendly button or issuing the ECOFRIENDLY LED and NO ECOFRIENDLY LED commands in the Global Configuration mode in the command line interface.

---

## VCStack Feature

---

You can use the switches as stand-alone units or join up to eight units with the VCStack feature. The switches of a VCStack act as a single virtual unit. They synchronize their actions so that switching operations (such as spanning tree protocols, virtual LANs, and static port trunks) span across all of the units and ports. Two advantages of stacks are:

- ❑ You can manage multiple units simultaneously, which can simplify network management.
- ❑ You have more flexibility in how you configure some of the features. For instance, a static port trunk on a stand-alone switch can consist of ports from the same switch. In contrast, a static trunk on a stack can have ports from different switches in the same stack.

---

### **Note**

This guide explains how to install switches as a stack with Virtual Chassis Stacking (VCStack™). For instructions on how to install the devices as stand-alone switches, refer to the *x530L Series Installation Guide for Stand-alone Switches*.

---

## Switch ID LED

---

The switch ID LED, shown in Figure 19, displays the ID number of the switch. A stand-alone switch has the ID number 0. Switches in a VCStack have the numbers 1 to 8. Chapter 7, “Building the Trunk with the Default 10Gbps Stacking Ports” on page 141 has the procedure for setting the ID numbers of the switches in a stack.

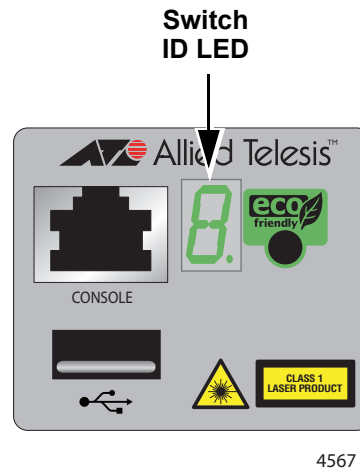

Figure 19. Switch ID LED

The states of the LED when the switch is not operating in the low power mode are shown in Figure 20.

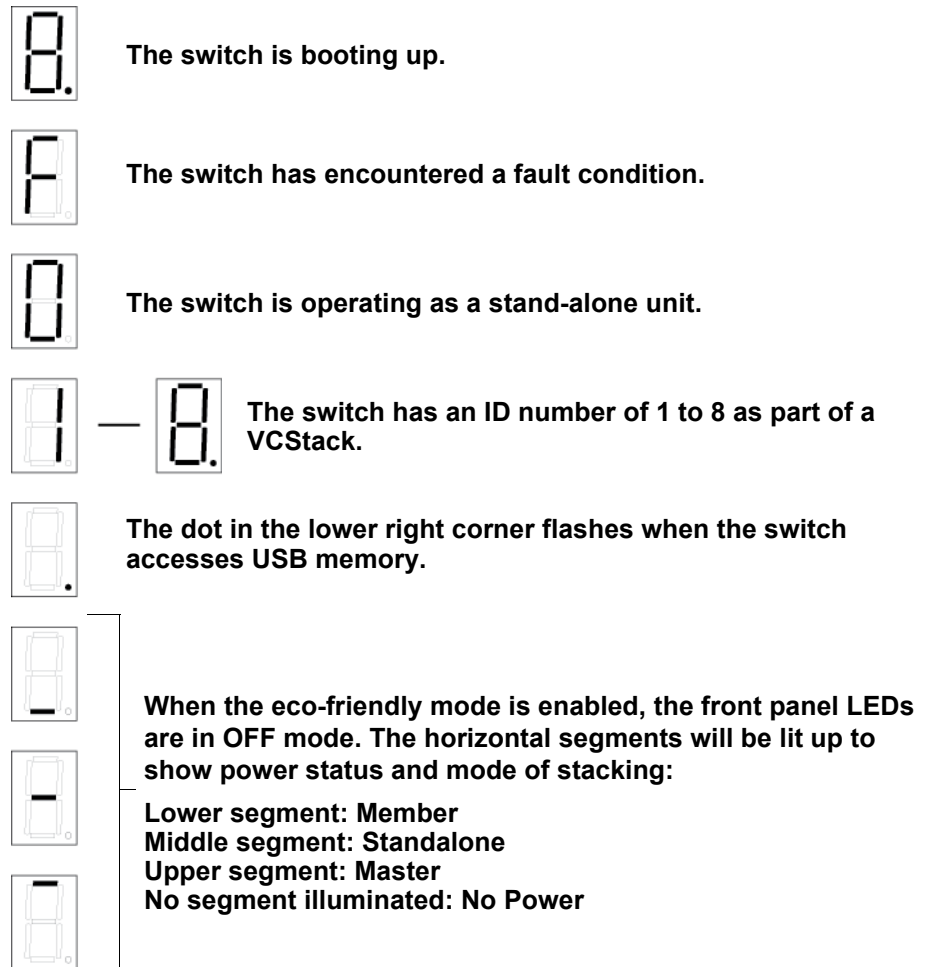

Figure 20. Switch ID LED Description

The switch displays the letter “F” for fault on the ID LED if it detects one of the following problems:

- A cooling fan has failed.
- The internal temperature of the switch has exceeded the normal operating range and the switch may shut down.

---

**Note**

You can use the SNMP or the command line management interface to determine the type of fault or faults.

---

## USB Port

---

The USB port on the management panel is used for the following functions:

- Store configuration files on flash drives.
- Restore configuration files to switches that have lost or corrupted settings.
- Configure replacement units by downloading configuration files from a flash drive.
- Update the management firmware.

The port is USB 2.0-compatible.



## Console Port

---

The Console port is an RS232 serial management port. You use the port to access the AlliedWare Plus management software on the switch to configure the feature settings or monitor status or statistics. This type of management is commonly referred to as local management because you have to be at the physical location of the switch and use the management cable included with the unit. The switch does not have to have an IP address for local management.

To establish a local management session with the switch, use the provided management cable to connect a terminal or a computer with a terminal emulation program to the Console port, which has an RJ-45 style (8P8C) connector. The cable has RJ-45 style (8P8C) and DB-9 (D-sub 9-pin) connectors.

The Console port has the following settings:

- Default baud rate: 9,600 bps (range is 9,600 to 115,200 bps)
- Data bits: 8
- Parity: None
- Stop bits: 1
- Flow control: None

---

**Note**

These settings are for a DEC VT100 or ANSI terminal, or an equivalent terminal emulation program.

---

## Power Supply

---

### Pre-Installed AC Power Supply

The x530L Series switches come with one or two pre-installed AC power supplies depending on the model:

- ❑ Two power supplies: x530L-28GPX, x530L-28GTX, x530L-52GTX and x530L-52GPX
- ❑ One power supply: x530L-10GHXm and x530L-18GHXm

Refer to “Power Specifications” on page 221 for the input voltage ranges.



#### Warning

The power cord is used as a disconnection device. To de-energize equipment, disconnect the power cord(s). ⚡ E3

---

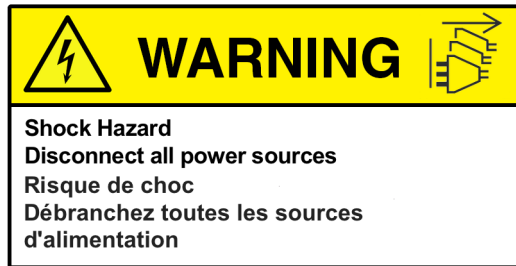

---

#### Note

Power supplies are not field-replaceable.

---

## Software and Hardware Releases

---

Software and hardware releases for the AlliedWare Plus operating software and x530L Series switches are listed in Table 16.

Table 16. Software and Hardware Releases

<b>Software Version</b>	<b>Hardware</b>	<b>VCStack</b>
v5.4.8-2	x530L-28GPX switch x530L-28GTX switch	Allows stacks of up to four switches using the SFP/SFP+ transceiver ports for the stack trunk.
v5.4.9-2	Adds the following switches: x530L-52GPX switch x530L-52GTX switch	Allows stacks of up to eight switches using the SFP/SFP+ transceiver ports for the stack trunk.
v5.5.0-2	Adds the following switches: x530L-10GHXm switch x530L-18GHXm switch	Allows stacks of up to eight switches using the SFP/SFP+ transceiver ports or the 1/2.5/5Gbps ports for the stack trunk.



## Chapter 2

# Virtual Chassis Stacking

---

The following sections are discussed in this chapter:

- ❑ “Overview” on page 58
- ❑ “Stacking Guidelines” on page 59
- ❑ “Stack Trunks” on page 61
- ❑ “Stack Trunks of 10Gbps Ports” on page 62
- ❑ “Stack Trunks of 5Gbps Ports on the x530L-10GHXm or x530L-18GHXm Switch” on page 71
- ❑ “Invalid Stack Trunks” on page 74
- ❑ “Master and Member Switches” on page 76
- ❑ “Switch ID Numbers” on page 78
- ❑ “Optional Feature Licenses” on page 79
- ❑ “Mixed Switch Stacks” on page 80
- ❑ “Planning the Stack” on page 83
- ❑ “Configuring Mixed-Mode VCStacking” on page 84
- ❑ “Stacking Worksheet” on page 85

---

### **Note**

For more information on VCStack, refer to the *Stacking Introduction and Stacking Commands* chapters in the *Command Reference: x530 Series Switches Running AlliedWare Plus Version 5.5.0* at [www.alliedtelesis.com/library](http://www.alliedtelesis.com/library).

---

## Overview

---

The VCStack feature is used to connect multiple x530L Series switches into a single, virtual networking unit. Some of the benefits of the VCStack feature are listed here:

- ❑ Simplifies management - You can manage the devices of the stack as a single unit, rather than individually. Your local and remote management sessions give you management access to all the switches in the stack.
- ❑ Reduces IP addresses - A stack requires only one IP address for remote management access, thereby reducing the number of IP addresses you have to assign to network devices.
- ❑ Adds feature flexibility and resiliency - A stack gives you flexibility in the available configurations of features. For example, you can create port aggregators of ports from different switches in a stack, rather than from only one switch. Distributing the ports of an aggregator across two or more switches in a stack increases its resiliency because it can continue to function, though at a reduced bandwidth, even if one of the switches stops functioning.
- ❑ Reduces protocol requirements - Building a stack might eliminate the need to configure some protocols, such as the Virtual Router Redundancy Protocol or Spanning Tree Protocol.

## Stacking Guidelines

---

This section lists the general guidelines to building a VCStack of x530L Series switches.

- ❑ A stack can have up to eight x530L Series switches.
- ❑ No additional software or licenses are required for stacking within the x530L Series switches.
- ❑ A stack can also have x530, x530DP and x530L Series switches. However, this type of stack, referred to as a mixed stack, requires a license and additional configuration commands. Refer to “Mixed Switch Stacks” on page 80.
- ❑ Stacking is enabled by default on the x530L and x530 Series switches
- ❑ The switches of a stack must be connected with a stack trunk, consisting of a minimum of two ports per switch.
- ❑ Although the ports support both 1Gbps SFP and 10 Gbps SFP+ transceivers, stack trunks require 10Gbps transceivers. Stack trunks are not supported with 1Gbps transceivers.
- ❑ The default stacking SFP+ ports are:
  - x530L-10GHXm: ports 9 and 10
  - x530L-18GHXm: ports 17 and 18
  - x530L-28GPX and x530L-28GTX: ports 27 and 28
  - x530L-52GPX and x530L-28GTX: ports 51 and 52
- ❑ You can increase the bandwidth and resiliency of the stack trunk by using the following additional SFP+ ports for stacking:
  - x530L-28GPX and x530L-28GTX: ports 25 and 26
  - x530L-52GPX and x530L-52GTX: ports 49 and 50
  - x530L-10GHXm and x530L-18GHXm do not have additional stacking SFP+ ports
- ❑ Stack trunks on the x530L-10GHXm and x530L-18GHXmswitches can also be built with the multi-speed 5Gbps ports.
- ❑ A stack of x530L Series switches cannot contain other stacking switches, such as x930 or x950 Series switches.
- ❑ The links of a stack trunk must be direct connections between switches. You cannot install a networking device, such as a media converter or Ethernet switch, between two stacking ports.
- ❑ SFP+ transceivers and direct attach cables used for a stack trunk must be from Allied Telesis. Switches will not form a stack with transceivers from other network equipment providers. For a list of supported transceivers, refer to the product data sheet on the Allied Telesis web site.

- ❑ When using a multi-speed port as a stack port, it supports 1 to 8 links.



## Stack Trunks

---

Stack trunks connect the switches of a stack together. A stack trunk consists of a minimum of two ports on each device. For switches with AlliedWare Plus v5.4.9 or later, you can choose the two ports of the trunk. Your choices are listed in Table 17:

Table 17. Default (10Gbps) and Optional (5Gbps) Trunk Ports

Switch	Optional Trunk Ports (5Gbps twisted pair ports)	Additional Trunk Ports (SFP+ 10Gbps SFP+ transceiver ports)	Default Trunk Ports (SFP+ 10Gbps SFP+ transceiver ports)
x530L-10GHXm	1-8	None	9/S1, 10/S2
x530L-18GHXm	1-16	None	17/S1, 18/S2
x530L-28GPX	None	25, 26	27/S1, 28/S2
x530L-28GTX	None	25, 26	27/S1, 28/S2
x530L-52GPX	None	49, 50	51/S1, 52/S2
x530L-52GTX	None	49, 50	51/S1, 52/S2

The guidelines are discussed in the following sections:

- “Stack Trunks of 10Gbps Ports” on page 62
- “Stack Trunks of 5Gbps Ports on the x530L-10GHXm or x530L-18GHXm Switch” on page 71

---

### Note

The following discussions apply to AlliedWare Plus v5.5.0 or later. Earlier versions of the operating system have different trunk rules and restrictions.

---

## Stack Trunks of 10Gbps Ports

---

You can build stack trunks with 10Gbps SFP+ transceiver ports on the switches. The guidelines are described here:

- ❑ Stacks can have up to eight switches.
- ❑ For stacking ports, you can use:
  - x530L-28GPX and x530L-28GTX ports 25 to 28
  - x530L-52GPX and x530L-52GTX ports 49 to 52
  - x530L-10GHXm ports 9 and 10
  - x530L-18GHXm ports 17 and 18
- ❑ SFP+ transceivers and direct attach cables used for a stack trunk must be from Allied Telesis. Switches will not form a stack with transceivers from other network equipment providers. For a list of supported transceivers, refer to the product data sheet on the Allied Telesis web site.

---

### Note

Transceiver must be purchased separately.

---

- ❑ The 10Gbps stacking ports and transceiver ports can be used as regular networking ports by disabling the stacking feature.
- ❑ A stack trunk can be either linear or ring. Ring is recommended because it adds redundancy. The stack can continue to function even if a trunk link fails.
  - See Figure 21 on page 63 for Valid Stack Trunk Using Default Stacking Ports 9 to 10 on 10-Port x530L Switches.
  - See Figure 22 on page 64 for Valid Stack Trunk Using Default Stacking Ports 17 to 18 on 18-Port x530L Switches.
  - See Figure 23 on page 65 for Valid Stack Trunk Using Default Stacking Ports 27 to 28 on 28-Port x530L Switches.
  - See Figure 24 on page 66 for Valid Stack Trunk Using Default Stacking Ports 51 to 52 on 52-Port x530L Switches.
- ❑ A stack trunk can have fiber optic and SP10TW direct connect cables in the same stack. See Figure 27 on page 70.

Figure 21 shows examples of stack trunks for two, three, and four switches, using the default stacking ports 9 and 10 on 10-port x530L-10GHXm switches.

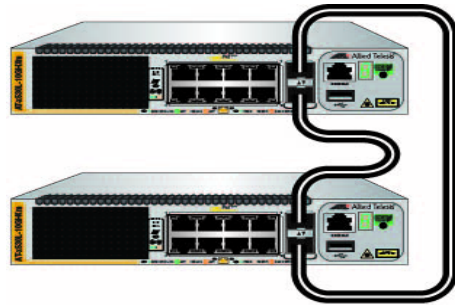

**Stack of Two Switches**

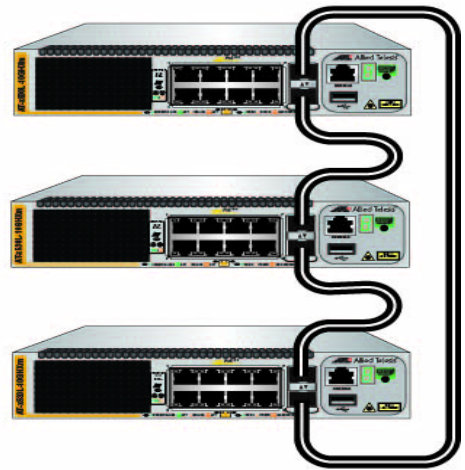

**Stack of Three Switches**

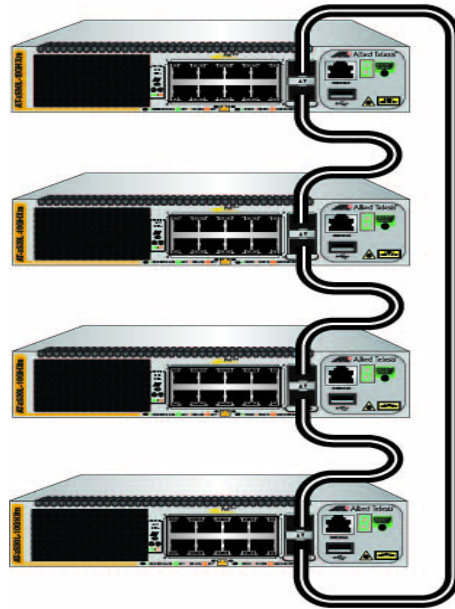

**Stack of Four Switches**

Figure 21. Valid Stack Trunk Using Default Stacking Ports 9 to 10 on 10-Port x530L Switches

Figure 22 shows examples of stack trunks for two, three, and four switches, using the default stacking ports 17 and 18 on 18-port x530L-18GHXm switches.

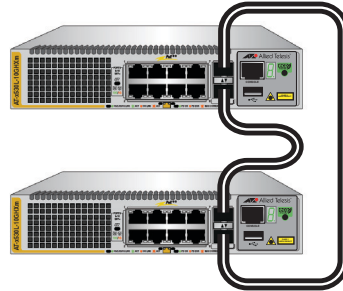

**Stack of Two Switches**

**Stack of Three Switches**

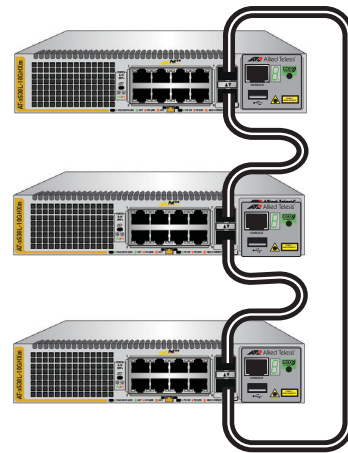

**Stack of Four Switches**

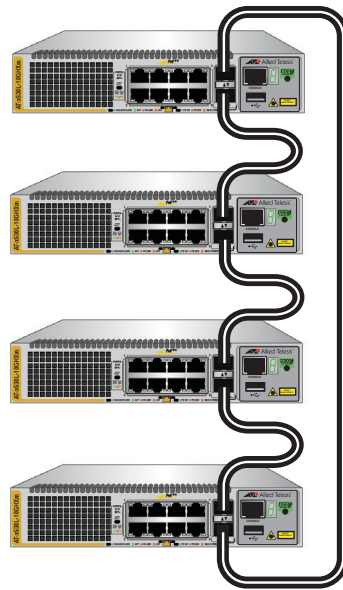

Figure 22. Valid Stack Trunk Using Default Stacking Ports 17 to 18 on 18-Port x530L Switches

Figure 23 shows examples of stack trunks for two, three, and four switches, using the default stacking ports 27 and 28 on 28-port x530L-28GPX and x530L-28GTX switches.

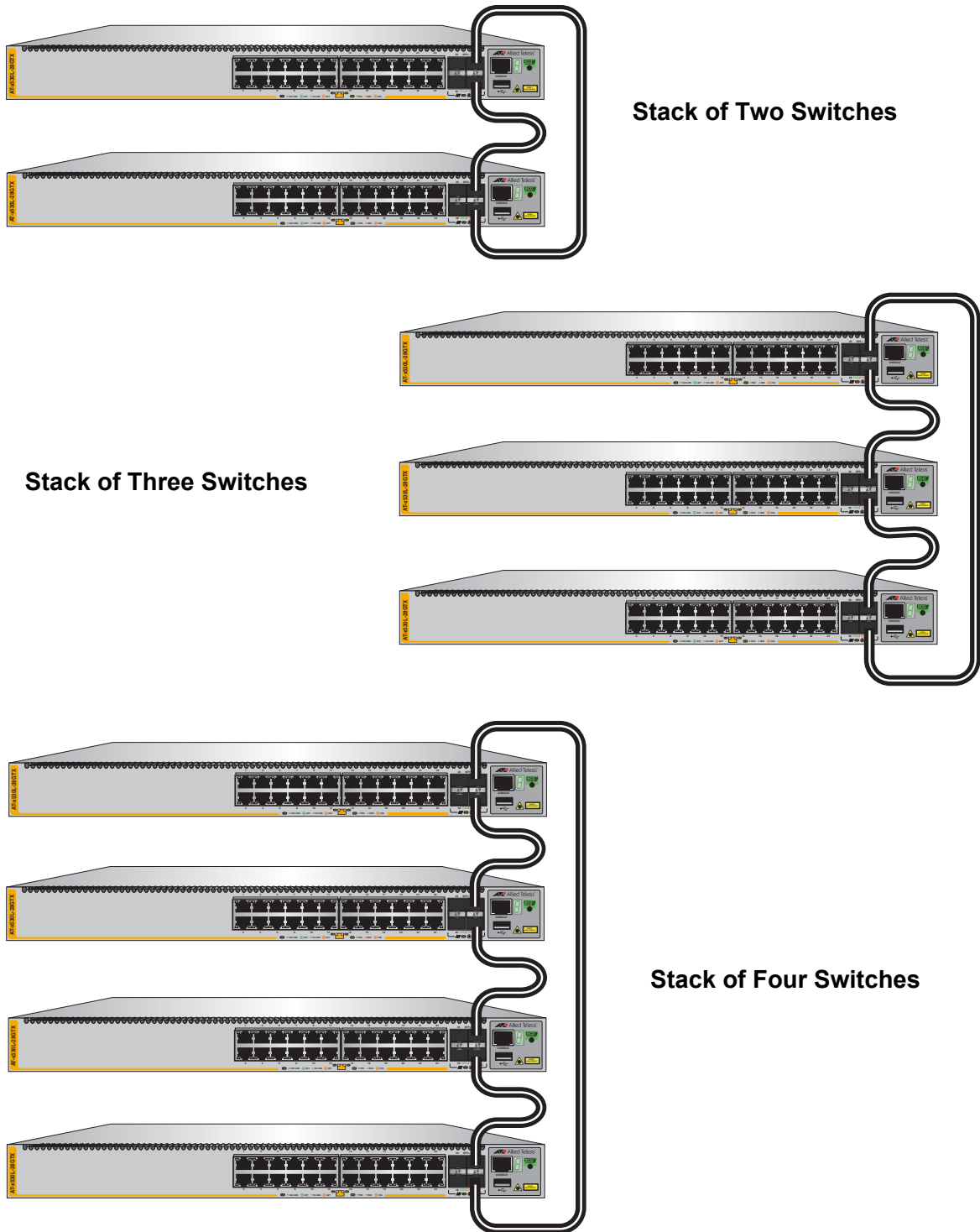

Figure 23. Valid Stack Trunk Using Default Stacking Ports 27 to 28 on 28-Port x530L Switches

Figure 24 shows examples of stack trunks for two, three, and four switches, using the default stacking ports 51 and 52 on 52-port x530L-52GPX and x530L-52GTX switches.

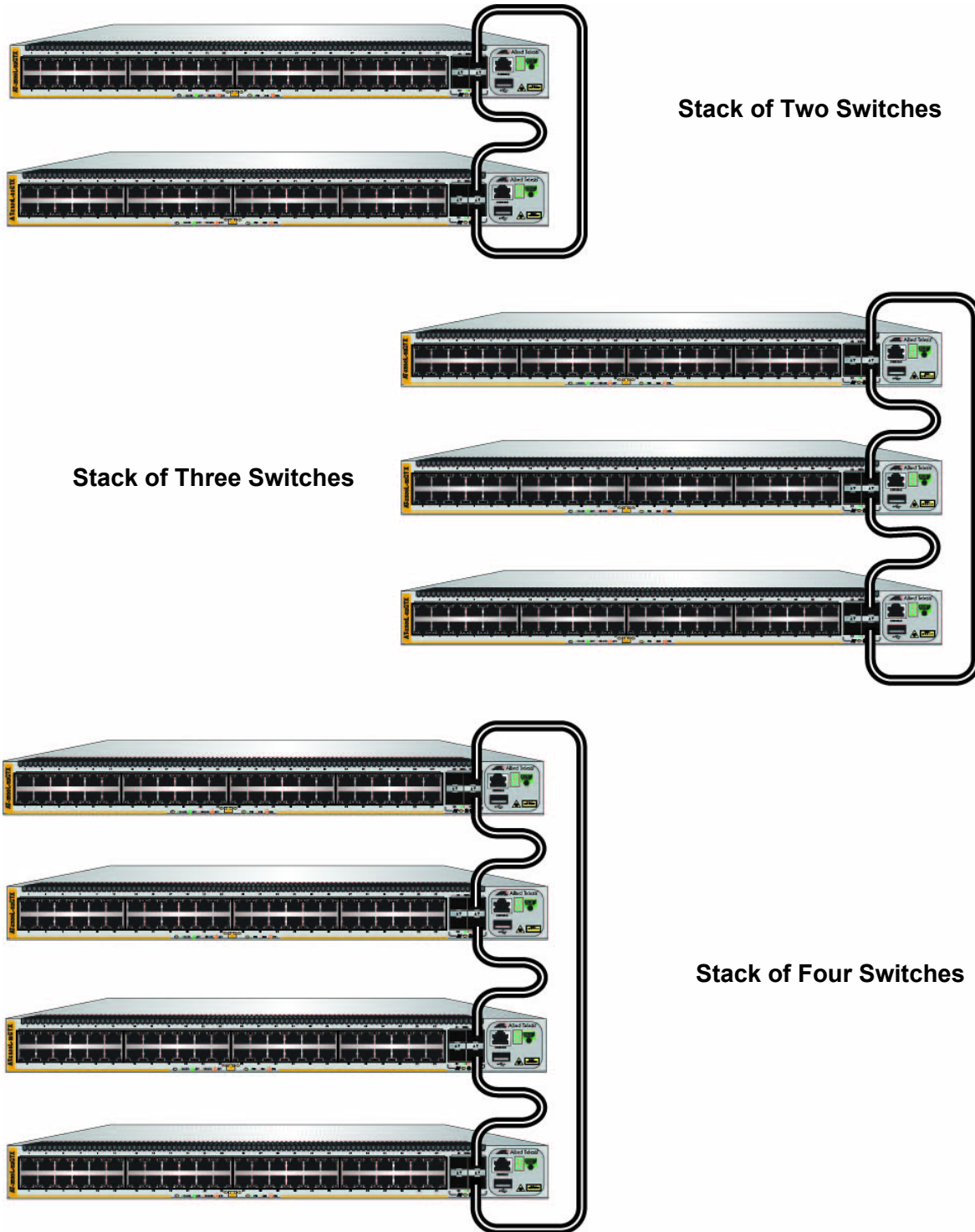

Figure 24. Valid Stack Trunk Using Default Stacking Ports 51 to 52 on 52-Port x530L Switches

In stacks of three or more 28- or 52-port switches the amount of inter-switch network traffic might require a stacking trunk with greater bandwidth than that provided by the default ports of:

- ❑ x530L-28GPX and x530L-28GTX ports 27 and 28.
- ❑ x530L-52GPX and x530L-52GTX ports 51 and 52.

For such situations these additional ports can be used:

- ❑ x530L-28GPX and x530L-28GTX ports 25 and 26.
- ❑ x530L-52GPX and x530L-52GTX ports 49 and 50.

Figure 25 shows examples of stacks of three and four switches using all four SFP+ ports for the stack trunk.

**Stack of Three Switches**

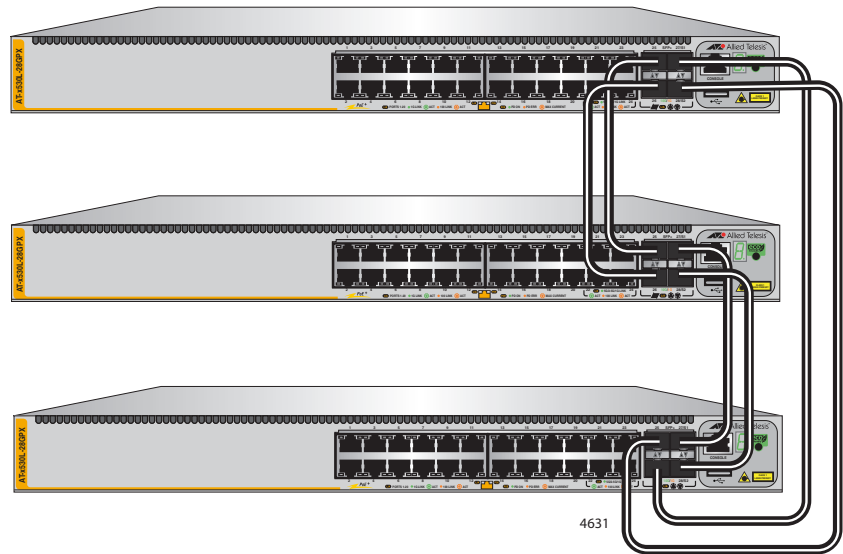

**Stack of Four Switches**

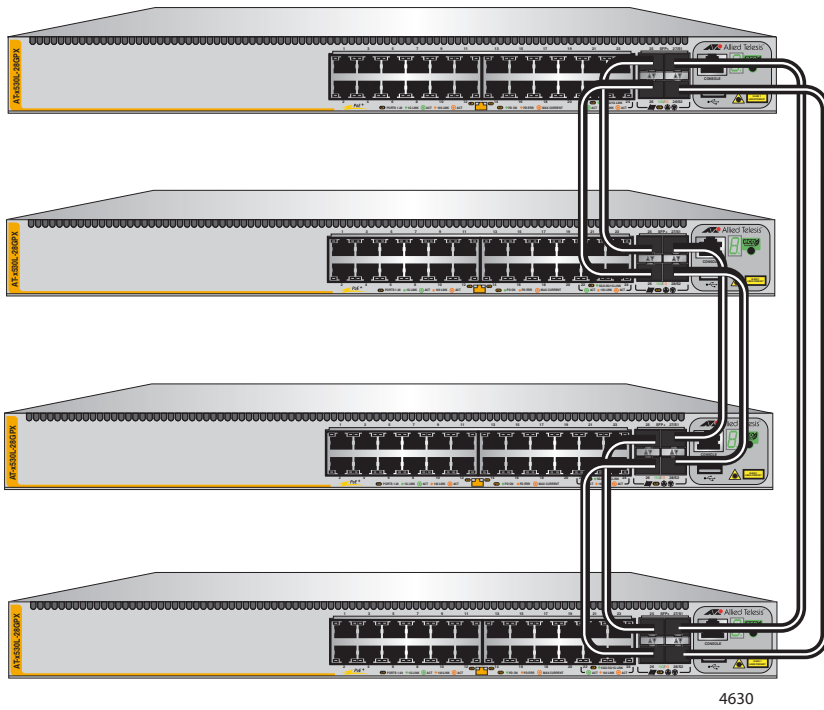

Figure 25. Valid Stack Trunks Using Ports 25 to 28



Figure 26 shows an example of a stack of four switches using all four SFP+ ports for the stack trunk with a combination of 28- and 52-port switches.

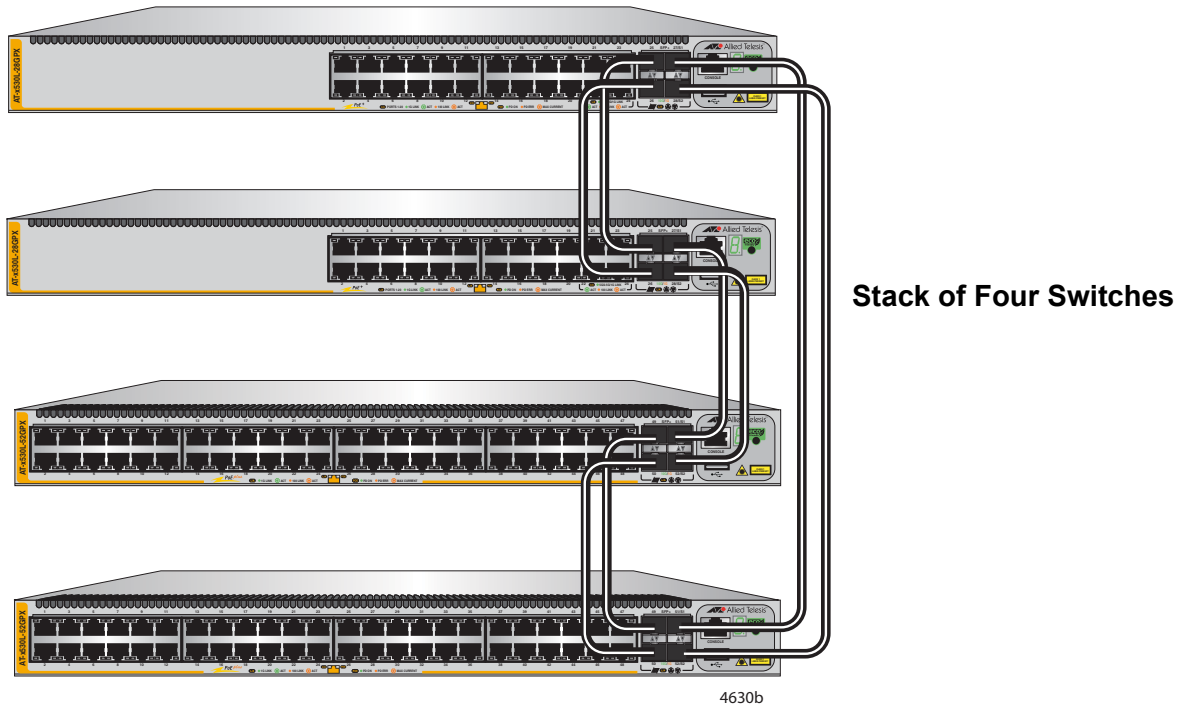

Figure 26. Valid Stack Trunks Using a Combination of Ports 25 to 28 and Ports 49 to 52

10Gbps stack trunks can have a combination of fiber optic transceivers and SP10TW direct attach cables. Figure 27 shows an example of a 10Gbps stack trunk with both fiber optic and SP10TW direct connect cables.

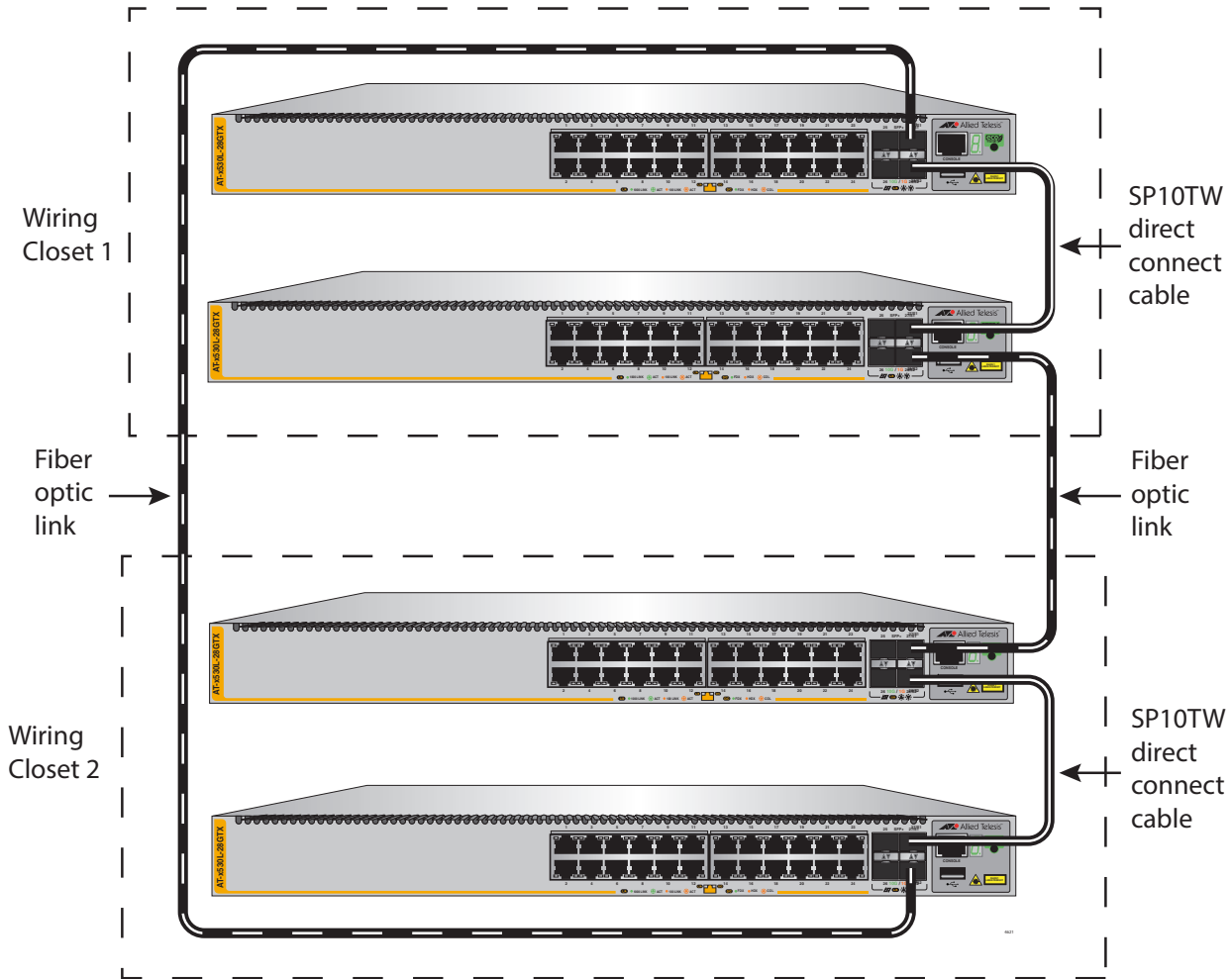

Figure 27. Valid 10Gbps Stack Trunk with Both Fiber Optic and SP10TW Direct Connect Cables

## Stack Trunks of 5Gbps Ports on the x530L-10GHXm or x530L-18GHXm Switch

---

The 10Gbps SFP+ ports on the x530L-10GHXm or x530L-18GHXm switch are not the only ports you can use for a trunk of a stack. If you prefer to use the 10Gbps ports for other functions, you can use the 5Gbps ports for the trunk instead. You can use all 5Gbps ports per switch for a trunk. As with a trunk based on 10 Gbps SFP+ ports, the more 5Gbps ports a trunk has, the greater its bandwidth and resiliency.

The rules and guidelines for a stack trunk of 5Gbps ports are similar to stack trunks of 10Gbps ports.

- ❑ Stacks can have up to eight switches.
- ❑ You can use 5Gbps ports for the trunk:
  - x530L-10GHXm ports 1 - 8
  - x530L-18GHXm ports 1 - 16
- ❑ The trunk can have from two or all 5Gbps ports per switch.
- ❑ A stack of x530L-10GHXm switches with a trunk of 5Gbps ports cannot contain other x530L switches because the other models do not have 5Gbps ports. To build a stack containing x530L-10GHXm or x530L-18GHXm switches and other x530L switches, you have to use 10Gbps ports for the trunk.
- ❑ When possible, you should use the same ports on all the switches of a stack. This is not a requirement, but it can make managing and troubleshooting a stack easier. For example, you might designate ports 5 and 6 and a stack of x530L-10GHXm switches to be the stacking ports.
- ❑ You designate the stack ports with the STACKPORT command.
- ❑ Once ports are designated as trunk ports, you cannot view or change their parameter settings.

A trunk of 5Gbps ports for a stack of two switches can have two or more links per switch. As mentioned previously, the more links in a trunk, the greater its bandwidth and resiliency. Examples are shown in Figure 28.



Figure 28. Trunks of 5Gbps Ports for Stacks of Two x530L-10GHXm Switches

A trunk of 5Gbps ports for a stack of three or more x530L-10GHXm switches can have from two to all 5Gbps ports per switch. Refer to Figure 29.

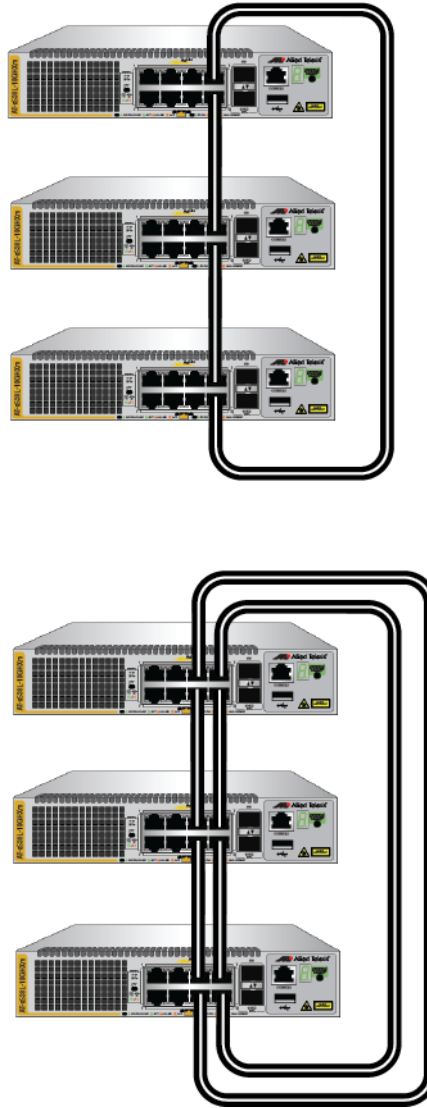

Figure 29. Trunks of 5Gbps Ports for Stacks of Three x530L-10GHXm Switches

## Invalid Stack Trunks

Figure 30 through Figure 33 on page 75 show examples of different types of invalid stack trunks.

**Example 1** Stack trunks must be direct links between trunk ports. There cannot be any intermediary networking devices, such as media converters, Ethernet switches, or routers, between trunk ports. Figure 30 is an example of this type of invalid trunk.

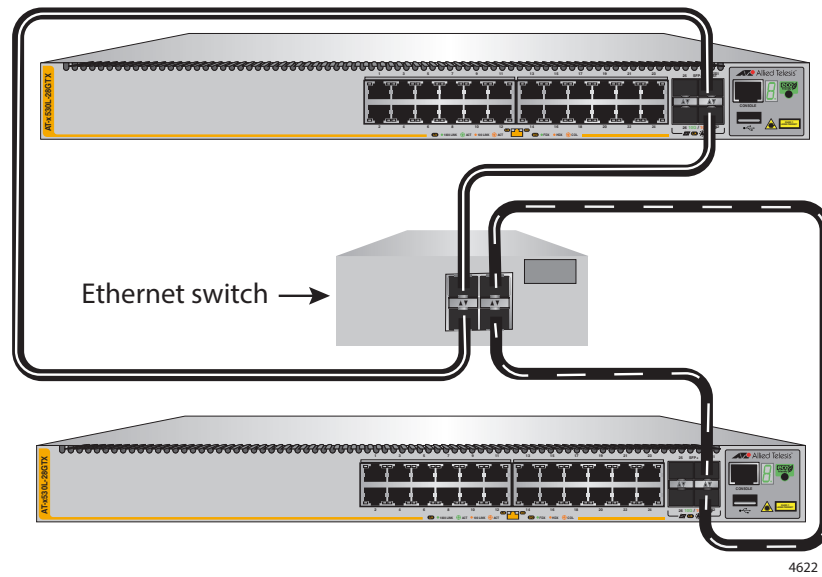

Figure 30. Invalid Stack Trunk with an Intermediary Networking Device

**Example 2** Trunks must have a minimum of two ports used per switch. Figure 31 is an example of an invalid stack trunk with one port used per switch.

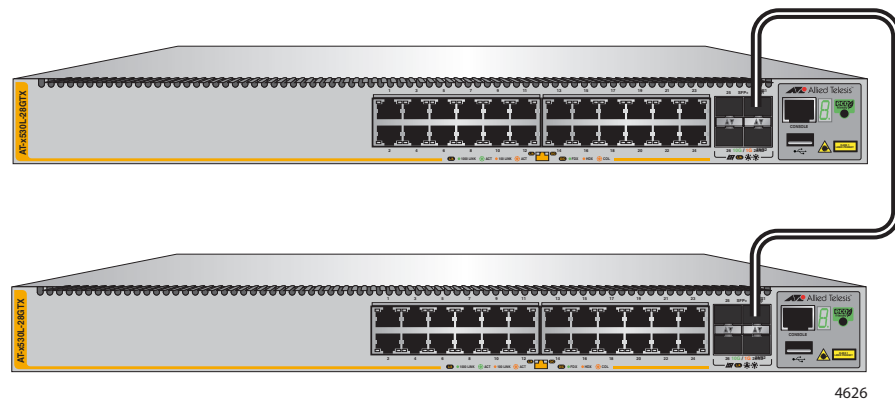

Figure 31. Invalid Stack Trunk with One Port Used Per Switch

**Example 3** Trunks must have the same number of physical links between switches. Figure 32 is invalid because the top and middle switches are connected with two links while the top and middle switches are connected to the bottom switch with only one link each.

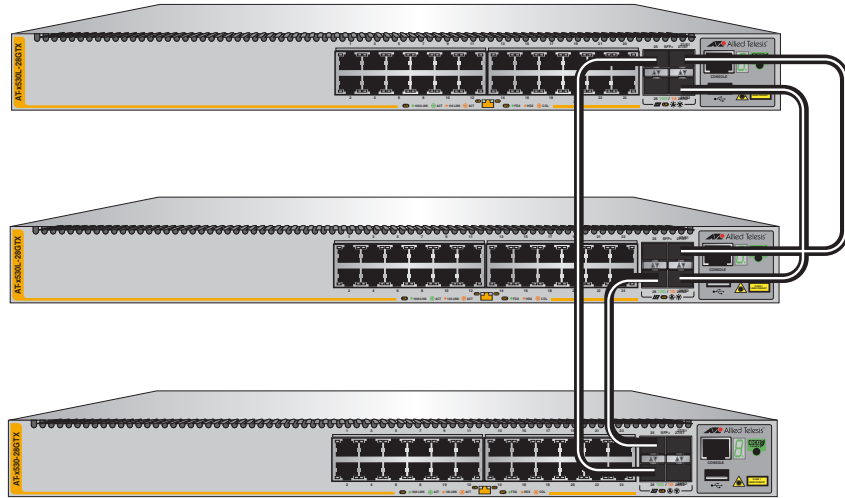
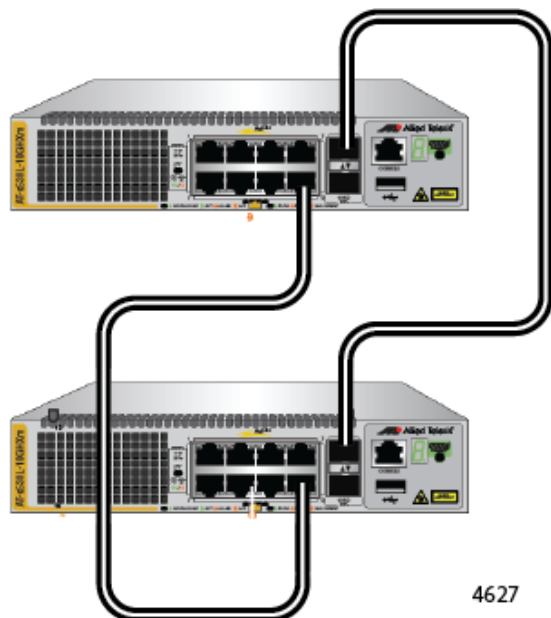

Figure 32. Invalid Stack Trunk with Different Numbers of Links

**Example 4** Trunks cannot contain both 1/2.5/5Gbps twisted pair ports and 10Gbps SFP+ ports. Figure 33 shows an example of an invalid stack trunk because it uses both types of ports.



4627

Figure 33. Invalid Stack Trunk with Different Port Types

## Master and Member Switches

---

A stack has one master switch. The other switches are member switches. The main functions of the master switch are listed here:

- ❑ Coordinate and monitor stack operations.
- ❑ Configure the parameter settings of the switches using its configuration file in flash memory, whenever the stack is reset or powered on.
- ❑ Verify that the switches are using the same version of management software. It automatically downloads its management software to the member switch over the stacking cables if the member switch has a different version of the management software.
- ❑ Verify that the switches have different ID numbers. It automatically assigns new ID numbers to resolve situations where two or more switches have the same ID number.
- ❑ Verify that the stacking transceivers are from Allied Telesis and they are cabled correctly.

The parameter settings of the switches of the stack are stored in configuration files in the flash memories of the master and member switches. Each file contains all the settings for the switches in the stack. The switches update the files with the latest parameter settings whenever you issue the `WRITE` command to save your changes.

When you reset or power on the stack, the master switch uses the configuration file in its flash memory to restore its own parameter settings as well as the parameter settings of the member switches in the stack. A member switch uses its configuration file to restore parameter settings only if the master switch is removed or fails, and it becomes the new master switch of the stack.

### Selection of the Master Switch

The switches of a stack select the master switch during the initialization process, which they perform whenever they are powered on or reset. The master switch is selected using the following parameters:

- ❑ Stack priority numbers
- ❑ MAC addresses

The stack priority number is an adjustable value of 0 to 255. The lower the number, the higher the priority. The switch with the lowest priority number (highest priority) becomes the master switch of a stack. The default priority value is 128.



When switches have the same priority values, they compare their MAC addresses to select the master switch. As with the priority value, the lower the MAC address, the higher the priority. The switch with the lowest MAC address becomes the master switch.

If you power on the stack for the first time without adjusting the priority values, the master switch is selected based on the MAC addresses if the units are powered on simultaneously. If you power on the switches one at a time, the master switch is the first switch to be powered on.

You can set the priority values of the switches either before or after you build the stack. Changing the values after the stack is operating does not change the parameter settings of the stack or the ID numbers of the devices.

It should be noted that the master switch of a stack does not have to have the ID number 1. It can have any ID number.

## Switch ID Numbers

---

Each switch in a stack must have a unique ID number. The possible ID numbers depend on the version number of the AlliedWare Plus management software. The ID numbers 1 to 8 for up to eight switches in a stack with AlliedWare Plus v5.4.9-2 or later. The default is 1.

The ID numbers are displayed on the ID LEDs on the front panels of the units. You can assign the numbers yourself or let the master switch assign the numbers automatically when you initially power on the stack.

Use the ID numbers to identify the individual switches and ports when configuring the devices with the commands in the management software.

The ID numbers are also used to identify the parameter settings of the switches in the configuration files. When the stack is reset or power cycled, the master switch uses the ID numbers to identify the devices to which the parameter settings belong.



### Caution

Do not change the ID numbers of the switches after configuring the parameter settings of the stack. Otherwise, the parameter settings might be applied to the wrong devices when you reset or power cycle the stack. *SR* E79

---

The switches do not use the ID numbers to select the master switch. The selection of the master switch is based on their priority numbers and MAC addresses, as explained in “Selection of the Master Switch” on page 76.

## Optional Feature Licenses

---

The x530L Series switches comes with the AlliedWare Plus operating system and a base set of features that are available as soon as you install the devices. Allied Telesis offers additional features and capabilities for the switches. They come with the AlliedWare Plus operating system, but have to be unlocked before you can use them. Unlocking optional features requires licenses from Allied Telesis. For a list of optional feature licenses for the product, refer to its product sheet on the Allied Telesis web site.

Here are the guidelines to feature licenses for a stack of x530L Series switches:

- ❑ The VCStack feature is part of the base features of the switch. It does not require an additional feature license.
- ❑ You can install feature licenses while the switches are operating as stand-alone units or a stack.
- ❑ When ordering feature licenses for the switches of a stack, you must order one license for each switch.
- ❑ The switches will form a stack even if they have different feature licenses. However, the additional features are only available on those switches that have the necessary licenses. The stack generates a warning message if it detects that the switches do not have the same feature licenses. To resolve the issue, you can use the REMOTE-LOGIN command to log onto the individual switches in a stack to install new licenses. For more information, refer to the *Software Reference for x530L Series Switches, AlliedWare Operating System* from [www.alliedtelesis.com](http://www.alliedtelesis.com).

## Mixed Switch Stacks

---

The x530 family consists of the following series of Gigabit Ethernet switches:

- ❑ x530L
- ❑ x530
- ❑ x530DP

If you have previously worked with other Allied Telesis products that support stacking, than you may already know that the feature is typically not supported across switches from different series. This means that all the switches of a stack usually have to be from the same series.

However, the x530 family of switches does permit stacks of switches from different x530 series. For instance, you might build stacks of both x530 and x530DP switches, or models from all three series.

Building mixed stacks that have x530L and one or more of the x530 or x530DP switches require a special license and several additional configuration steps. This is because x530L switches have different base feature sets in their base licenses than the other switches. Stacks, on the other hand, require that all switches have the same feature sets. The following sections explain how to build mixed stacks of x530L and one or more of the other switches.

---

### Note

The following discussions do not apply to mixed stacks of x530 series and x530DP switches. The feature sets in their base licenses are the same. Consequently, building mixed stacks of those switches does not require a special license or additional configurations steps. Additionally, you can build the trunks using either SFP+ ports or multi-speed 1/2.5/5 twisted pair ports.

---

## Stack Mixed-Mode Licenses

One of the first steps to building a mixed stack of x530L switches and one or more x530 or x530DP switches is to obtain stack mixed-mode licenses from Allied Telesis and install the licenses on the switches. Switches of mixed stacks need the licenses to form the stacks.

The different switch series have different stack mixed-mode licenses. To receive the correct type and number of licenses, be sure to specify the number of x530L, x530, and x530DP switches when ordering the licenses.

## Stack Mixed-Mode Commands

After installing the stack mixed-mode licenses, you have to enter the STACK MIXED-MODE command in the Global Configuration mode of the AlliedWare Plus operating system. The command designates the switches as part of a mixed stack. When you issue this command on x530 series or x530DP switches, they configure their base feature sets to match the feature set in the base licenses in x530L switches.

## Trunk Ports

A key component of a stack is the trunk. These are the ports that link the switches together. With the x530L-10GHXm, x530L-18GHXm, x530, and x530DP switches, you have the choice of selecting the trunk ports from the SFP+ ports or multi-speed 1/2.5/5Gbps twisted pair ports.

The 28- and 52 port x530L switches, however, do not have multi-speed twisted pair ports. Consequently, to build a stack with those switches, regardless of whether it's a mixed stack or not, you have to use the SFP+ ports as the trunk ports. In contrast, the x530L-10GHXm and x530L-18GHXm switches do have multi-speed twisted pair ports. The trunk of a mixed stack of x530L-10GHXm, x530L-18GHXm, x530, or x530DP switches can be either SFP+ or multi-speed twisted pair ports. Refer to "Stack Trunks of 10Gbps Ports" on page 62.

## Optional Licenses

Here are guidelines for optional licenses in mixed stacks of x530L and x530 and/or x530DP switches:

- Mixed stacks do not support premium licenses. Do not install premium licenses on switches in mixed stacks.
- Mixed stacks do support the G8032 ring protection and continuous PoE power licenses.
- All the switches in the stack must have the same optional licenses.

## AlliedWare Plus

Mixed stacks require AlliedWare Plus v5.4.9 and later.

## Guidelines

Here are the guidelines to building mixed stacks of x530L and x530 or x530DP switches:

- For a mixed stack of x530L-10GHXm, x530L-18GHXm, x530 or x530DP switches, you can use either SFP+ or multi-speed twisted pair ports for the trunk.

- ❑ For a mixed stack of 28- or 52-port switches, the trunk ports have to be SFP+ ports.
- ❑ The switches should have AlliedWare Plus v5.4.9 or later.
- ❑ You have to install stack mixed-mode licenses on all the switches.
- ❑ You have to perform the STACK MIXED-MODE command on all the switches so that they operate with the same base set of features.
- ❑ If you break-up a mixed stack or remove the x530L switches, perform the NO STACK MIXED-MODE command on the x530 and x530DP switches to restore their full feature sets.
- ❑ If you break-up a mixed stack or remove the x530L switches, you can leave the stack mixed-mode licenses on the switches. They will not interfere with switch operations.
- ❑ The STACK MIXED-MODE and NO STACK MIXED-MODE commands require rebooting the switch.
- ❑ Mixed stacks do not support premium licenses.
- ❑ Mixed stacks do support the G8032 ring protection and continuous PoE power licenses.
- ❑ If optional licenses are installed on the switches, all the units must have the same licenses. Switches that have different feature licenses might still be able to form the stack, but the feature inconsistencies are logged and appear in the show license output.
- ❑ A mixed stack generates the following log message if the STACK MIXED-MODE command was not performed on all the switches:  

```
16:22:21 awplus VCS[1631]: Member 1 cannot join the stack because of stack mixed mode incompatibility. Enable 'stack mixed-mode'.
```
- ❑ The trunk for a mixed stack can have a minimum of two ports and a maximum of eight ports per switch.
- ❑ Trunk ports are designated with the STACKPORT command in the Port Interface mode.
- ❑ If you designate more than eight ports as trunk ports on a switch, only the first eight ports function as trunk ports.
- ❑ If you designate less than two ports for the trunk on a switch, the default trunk ports are used instead.
- ❑ A trunk should not contain both 5Gbps twisted pair ports and 10Gbps SFP+ ports. Network performance will be unpredictable.
- ❑ A trunk should not connect a switch to more than two other stack members. Building a mesh configuration where a member switch is directly connected to more than two other members is not supported and can cause unpredictable behavior.

## Planning the Stack

---

Here are factors to consider when planning a stack:

- ❑ Have you selected the stack ports for the trunk? The default stack ports are 10Gbps ports. Refer to “Stack Trunks” on page 61.
- ❑ How many x530L switches will be in the stack? The maximum is eight switches.
- ❑ Have you determined the required number of SFP+ transceivers or SP10TW direct attach cables for the trunk? Refer to Figure 23 on page 65 and Figure 25 on page 68.
- ❑ Have you selected a master switch? This can be any switch. If the switches have different versions of the AlliedWare Plus management software, the master switch should have the most recent version. Refer to “Selection of the Master Switch” on page 76.
- ❑ Have you selected ID numbers, in the range of 1 to 8, for the switches? You can control the ID number assignments by the order in which you initially power on the switches, or you can have the switches assign the numbers automatically. Refer to “Switch ID Numbers” on page 78 and “Powering On the Switches Individually” on page 144.
- ❑ If you are building a mixed stack of x530L switches and one or more x530 or x530DP switches, have you obtained stack mixed-mode licenses for the units?
- ❑ Have you already connected network cables to the trunk ports? If so, you should disconnect them before configuring the switches for stacking.

## Configuring Mixed-Mode VCStacking

---

To configure mixed-mode VCStacking, on each unit in the stack you must:

1. Install the mixed-mode stacking license. Once you have downloaded your license, you can transfer it onto the device's Flash storage by any preferred method. For example, you can use the copy command to copy the file from a USB device to your Flash storage.
2. Enter the mixed-mode VCStacking command:

The command is: `awplus (config) # STACK MIXED-MODE`

3. Save the configuration.
4. Re-boot.



## Stacking Worksheet

---

Configuring and maintaining a stack may be easier if you use the worksheet in Table 18.

Table 18. Stacking Worksheet

Switch	Switch Model/ Location	ID	Priority	AW+ Version Number	Trunk Ports
Master		1	1		
Member		2	2		
Member		3	3		
Member		4	4		
Member		5	5		
Member		6	6		
Member		7	7		
Member		8	8		

The table columns are described in Table 19.

Table 19. Stacking Worksheet Columns

Column	Description
Location	<p>You use this column to write down the physical locations of the devices, such as their buildings or equipment rooms. The information can be useful in locating the switches of the stack if they are in different locations.</p>
ID	<p>Each switch in a stack has to have a unique ID number, in the range of 1 to 8. They display the numbers on the ID LEDs on the front panels and you use the numbers to configure the individual ports. Allied Telesis recommends assigning the ID 1, the default value, to the master switch. You should decide ahead of time, before beginning the configuration procedures, the ID assignments of the switches.</p>
Priority	<p>When the switches of a stack are reset or powered on, they perform an initialization process that involves, in part, choosing the master switch. The selection is based on their priority numbers and MAC addresses. The former is an adjustable parameter with a range of 0 to 255 and a default value of 128. The lower the value, the higher the priority. Thus, the switch with the lowest value becomes the stack master.</p> <p>If switches have the same priority number, the master is selected based on their MAC addresses. Again, as with priority numbers, the lower the MAC address, the higher the priority.</p> <p>Allied Telesis recommends setting each switch's priority value to match its ID value. This is to ensure that the switch you have chosen to be the master unit will indeed function in that role. Additionally, it will make it possible for you to know the order in which the switches assume the master role if the primary master should fail or be powered off.</p>

Table 19. Stacking Worksheet Columns (Continued)

<b>Column</b>	<b>Description</b>
AW+ Version Number	This column is for writing down the version numbers of the AlliedWare Plus management software on the switches. The switches might not be able to form the stack if they have different versions. The configuration instructions explain how to view the version numbers. If they have different versions, you should update them to the most recent release before building the stack.
Trunk Ports	This column is for the ports of the trunk. This will be the default ports or the optional trunk ports. If you have not yet chosen the ports yet, you should do so before beginning the configuration procedures.



## Chapter 3

# Beginning the Installation

---

This chapter contains the following sections:

- “Reviewing Safety Precautions” on page 90
- “Choosing a Site for the Switch” on page 95
- “Unpacking the x530L-10GHXm Switch” on page 96
- “Unpacking the x530L-18GHXm Switch” on page 99
- “Unpacking the x530L-28GTX, x530L-28GPX, x530L-52GTX, or x530L-52GPX Switch” on page 101

## Reviewing Safety Precautions

---

Please review the following safety precautions before beginning the installation procedure.

**Important:** Safety statements that have the  symbol are translated into multiple languages in the *Translated Safety Statements* document at <https://www.alliedtelesis.com/en/documents/translated-safety-statements>.

**Remarque:** Les consignes de sécurité portant le symbole  sont traduites dans plusieurs langues dans le document *Translated Safety Statements*, disponible à l'adresse <https://www.alliedtelesis.com/en/documents/translated-safety-statements>.

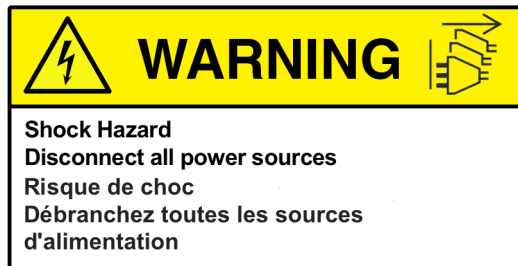

---

**Warning**

Class 1 Laser product.  L1

---



---

**Warning**

Laser Radiation.  
Class 1M Laser product.

---



---

**Warning**

Do not stare into the laser beam.  L2

---



---

**Warning**

Do not look directly at the fiber optic ends or inspect the cable ends with an optical lens.  L6

---

**Warning**

To prevent electric shock, do not remove the cover. No user-serviceable parts inside. This unit contains hazardous voltages and should only be opened by a trained and qualified technician. To avoid the possibility of electric shock, disconnect electric power to the product before connecting or disconnecting the LAN cables. ⚡ E1

---

**Warning**

Do not work on equipment or cables during periods of lightning activity. ⚡ E2

---

**Warning**

Power cord is used as a disconnection device. To de-energize equipment, disconnect the power cord. ⚡ E3

---

**Warning**

Class I Equipment. This equipment must be earthed. The power plug must be connected to a properly wired earth ground socket outlet. An improperly wired socket outlet could place hazardous voltages on accessible metal parts. ⚡ E4

---

---

**Note**

Pluggable Equipment. The socket outlet shall be installed near the equipment and shall be easily accessible. ⚡ E5

---

**Caution**

Air vents must not be blocked and must have free access to the room ambient air for cooling. ⚡ E6

---

**Warning**

Operating Temperatures. This product is designed for a maximum ambient temperature of 50° C. ⚡ E52

---

---

**Note**

All Countries: Install product in accordance with local and National Electrical Codes. ⚡ E8

---



**Warning**

Only trained and qualified personnel are allowed to install or replace this equipment. *↪* E14

---



**Caution**

Circuit Overloading: Consideration should be given to the connection of the equipment to the supply circuit and the effect that overloading of circuits might have on overcurrent protection and supply wiring. Appropriate consideration of equipment nameplate ratings should be used when addressing this concern. *↪* E21

---



**Caution**

Risk of explosion if battery is replaced by an incorrect type. Replace only with the same or equivalent type recommended by the manufacturer. Dispose of used batteries according to the manufacturer's instructions.

**Attention:** Le remplacement de la batterie par une batterie de type incorrect peut provoquer un danger d'explosion. La remplacer uniquement par une batterie du même type ou de type équivalent recommandée par le constructeur. Les batteries doivent être éliminées conformément aux instructions du constructeur. *↪* E22

---



**Warning**

Mounting of the equipment in the rack should be such that a hazardous condition is not created due to uneven mechanical loading. *↪* E25

---



**Warning**

The chassis may be heavy and awkward to lift. Allied Telesis recommends that you get assistance when mounting the chassis in an equipment rack. *↪* E28

---

---

**Note**

Use dedicated power circuits or power conditioners to supply reliable electrical power to the device. *↪* E27

---



**Warning**

This unit might have more than one power cord. To reduce the risk of electric shock, disconnect all power cords before servicing the unit.

 E30

---

**Note**

If installed in a closed or multi-unit rack assembly, the operating ambient temperature of the rack environment may be greater than the room ambient temperature. Therefore, consideration should be given to installing the equipment in an environment compatible with the manufacturer's maximum rated ambient temperature (Tmra).

 E35

---

**Caution**

Installation of the equipment in a rack should be such that the amount of air flow required for safe operation of the equipment is not compromised.  E36

---

**Warning**

Reliable earthing of rack-mounted equipment must be maintained. Particular attention must be given to supply connections other than direct connections to the branch circuits (e.g., use of power strips).

 E37

---

**Warning**

To reduce the risk of electric shock, the PoE ports on this product must not connect to cabling that is routed outside the building where this device is located.  E40

---

**Warning**

This product may have multiple AC power cords installed. To de-energize this equipment, disconnect all power cords from the device.

 E41

---

**Caution**

An Energy Hazard exists inside this equipment. Do not insert hands or tools into open chassis ports or plugs.  E44

---



**Warning**

This equipment must be installed in a Restricted Access location.  
E45

---



**Caution**

The unit does not contain serviceable components. Please return damaged units for servicing. E42

---



**Warning**

The temperature of an operational SFP or SFP+ transceiver may exceed 70° C (158° F). Exercise caution when removing or handling a transceiver with unprotected hands. E43

---

## Choosing a Site for the Switch

---

Observe these requirements when planning the installation of the switch.

- ❑ Before installing the switch in an equipment rack, check that the rack is safely secured so that it will not tip over. Devices in a rack should be installed starting at the bottom, with the heavier devices near the bottom of the rack.
- ❑ Before installing the switch on a table, check that the table is level and stable.
- ❑ The power outlets should be located near the switch and be easily accessible.
- ❑ The site should allow for easy access to the ports on the front of the switch, so that you can easily connect and disconnect cables, and view the port LEDs.
- ❑ The site should allow for adequate air flow around the unit and through the cooling vents on the front and rear panels. (The ventilation direction is from front to back.)
- ❑ The site must not expose the switch to moisture or water.
- ❑ The site must be a dust-free environment.
- ❑ The site must have dedicated power circuits or power conditioners to supply reliable electrical power to the network devices.
- ❑ Do not install the switch in a wiring or utility box because it might overheat and fail from inadequate air flow.



### **Warning**

Switches should not be stacked on a table or desktop. They could present a physical safety hazard if you need to move or replace switches. *↻* E91

---

## Unpacking the x530L-10GHXm Switch

---

Figure 34 shows the shipping box for the x530L-10GHXm Switch.

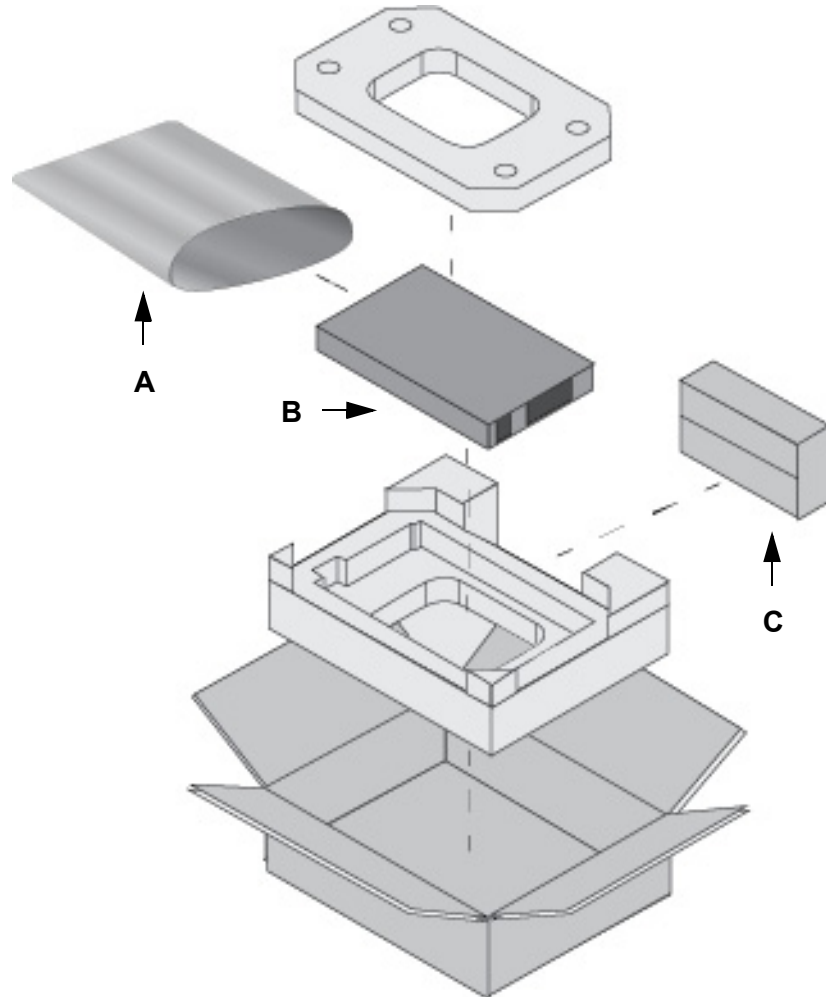

Figure 34. x530L-10GHXm Switch Shipping Box

The items in the box are listed here:

- A - Protective bag
- B - x530L-10GHXm Switch
- C - Accessory kit

---

**Note**

You should retain the original packaging material in case you need to return the unit to Allied Telesis.

---

Figure 35 here and Figure 36 on page 98 list the items in the accessory kit. Contact your Allied Telesis sales representative for assistance if any item is missing or damaged.

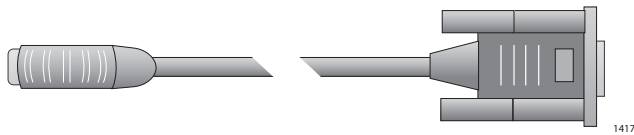

One 2m (6.6 ft) local management cable with RJ-45 (8P8C) and DB-9 (D-sub 9-pin) connectors.

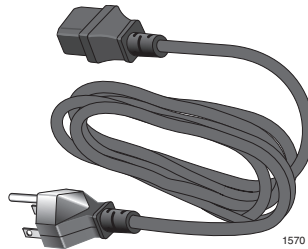

One regional AC power cord

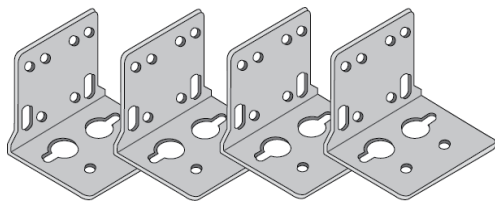

Four BRKT-J24 wall mounting brackets

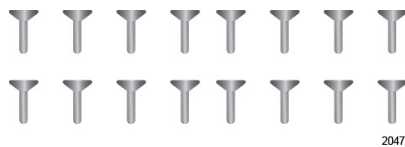

Sixteen screws for attaching the BRKT-J24 wall brackets to the switch.

Length: 6.0mm (0.2 in.)

Diameter: 4.0mm (0.2 in.)

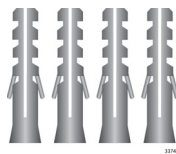

Four anchors for concrete walls:

Length: 29.6mm (1.2 in.)

Diameter: 6.0mm (0.2 in.)

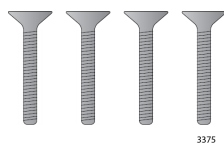

Four screws for wood or concrete walls:

Length: 32mm (1.3 in.)

Diameter: 4mm (0.2 in.)



Power cord retaining clip

Figure 35. x530L-10GHXm Switch Accessory Kit

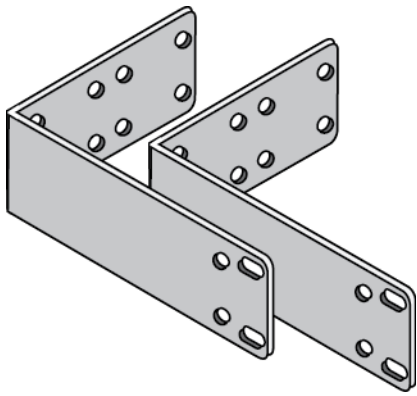

Two RKMT-J14 equipment rack brackets

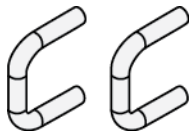

Two handles for the RKMT-J14 equipment rack brackets



Four screws for attaching the handles to the RKMT-J14 equipment rack brackets:

Length: 6.0mm (0.2 in.)

Diameter: 3.0mm (0.1 in.)

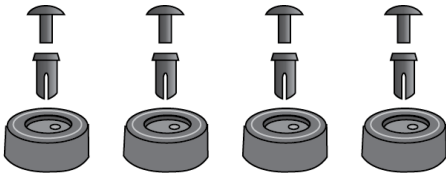

Four rubber bumper feet

Figure 36. x530L-10GHXm Switch Accessory Kit (Continued)

## Unpacking the x530L-18GHXm Switch

Figure 37 shows the shipping box for the x530L-18GHXm Switch.

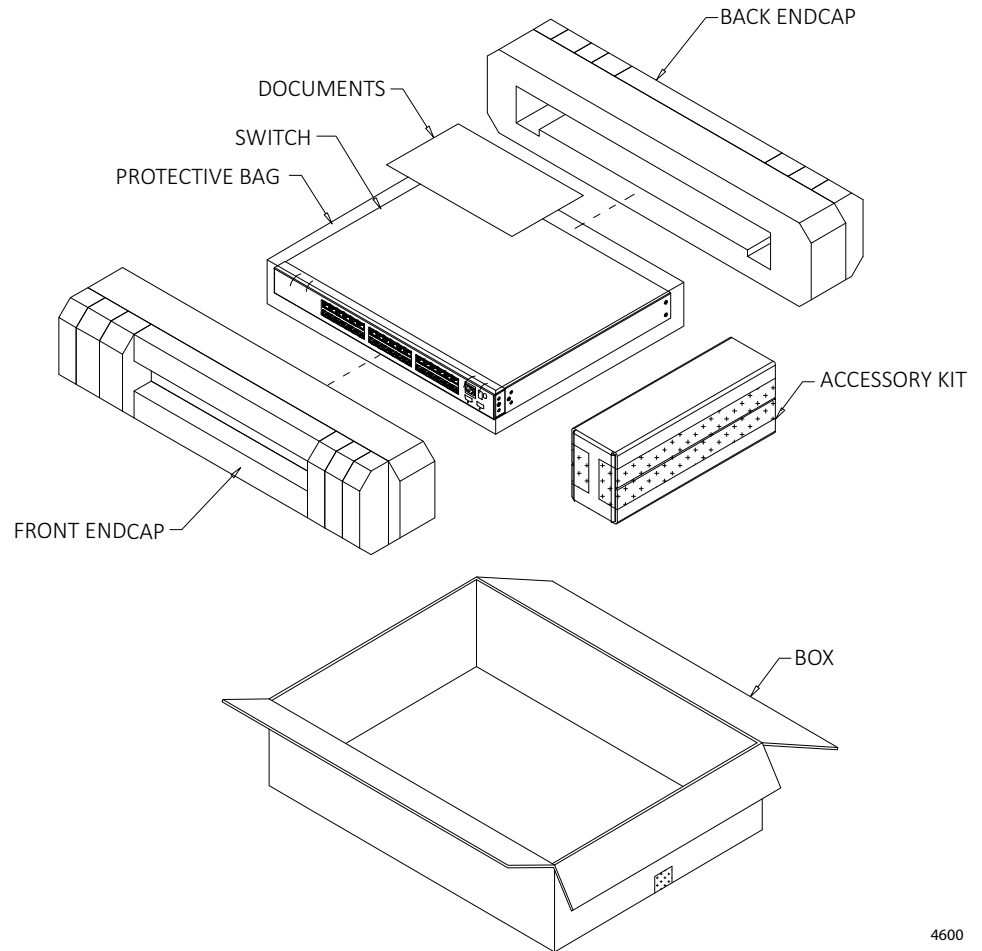

4600

Figure 37. x530L-18GHXm Switch Shipping Box

The items in the box are listed here:

- Protective bag
- x530L-18GHXm Switch
- Accessory kit

---

### Note

You should retain the original packaging material in case you need to return the unit to Allied Telesis.

---

Figure 38 lists the items in the accessory kit. Contact your Allied Telesis sales representative for assistance if any item is missing or damaged.

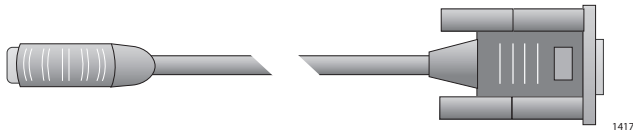

One 2m (6.6 ft) local management cable with RJ-45 (8P8C) and DB-9 (D-sub 9-pin) connectors.

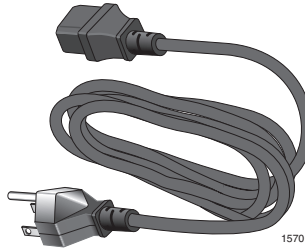

One regional AC power cord

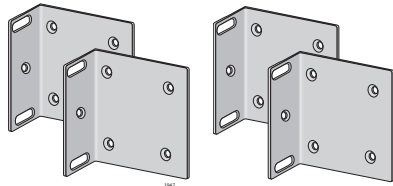

Four wall mounting brackets

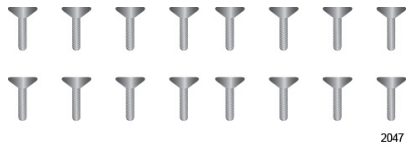

Sixteen screws for attaching the wall/equipment rack brackets to the switch.

Length: 6.0mm (0.2 in.)  
Diameter: 4.0mm (0.2 in.)

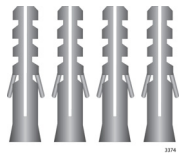

Four anchors for concrete walls:  
Length: 29.6mm (1.2 in.)  
Diameter: 6.0mm (0.2 in.)

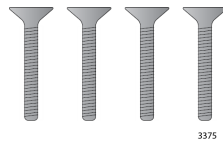

Four screws for wood or concrete walls:  
Length: 32mm (1.3 in.)  
Diameter: 4mm (0.2 in.)



Power cord retaining clip

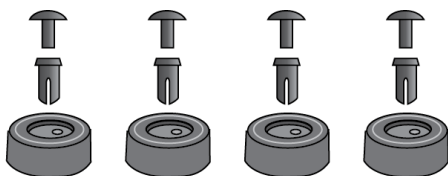

Four rubber bumper feet

Figure 38. x530L-18GHXm Switch Accessory Kit



## Unpacking the x530L-28GTX, x530L-28GPX, x530L-52GTX, or x530L-52GPX Switch

Figure 39 shows the items provided in the shipping box for the switch.

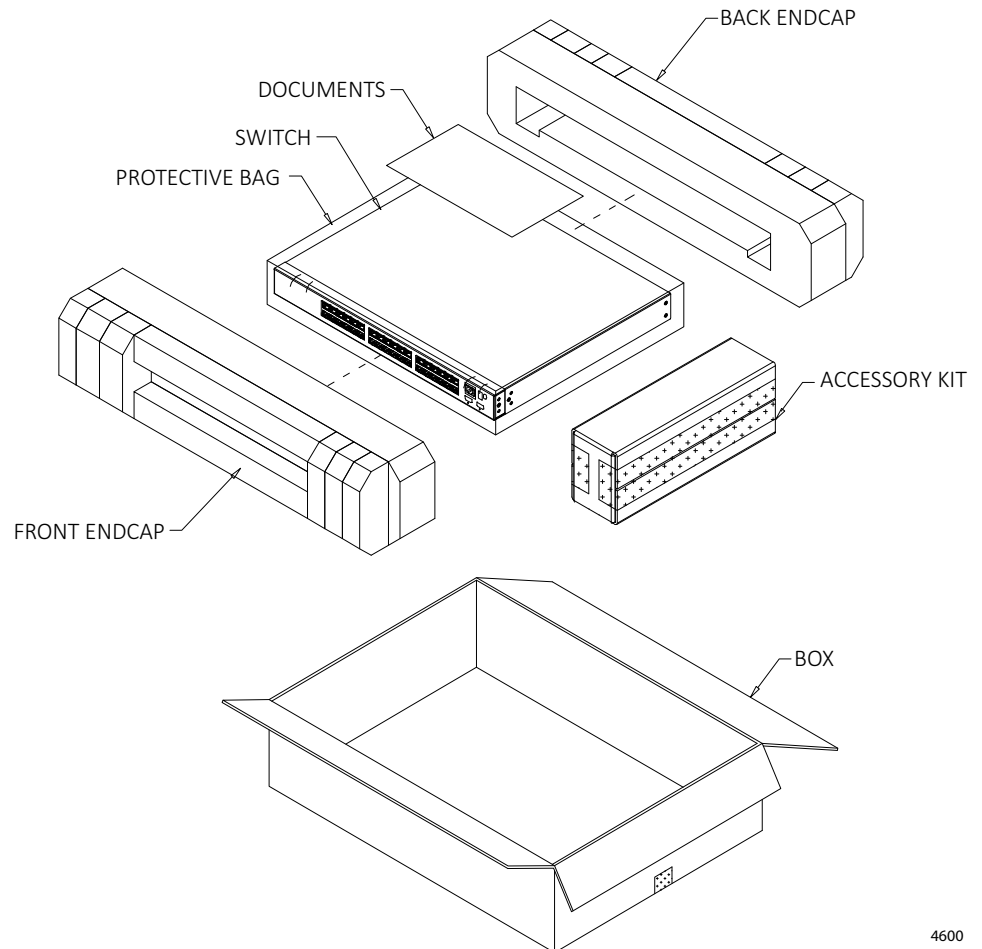

4600

Figure 39. 28- or 52-Port Switch Shipping Box

The main items provided in the shipping box for the switch are:

- Protective bag
- The switch
- Accessory kit (refer to Figure 40 on page 102)

---

### Note

Retain the original packaging material in case you need to return the unit to Allied Telesis.

---

Figure 40 lists the items that are included in the x530L-28GTX, x530L-28GPX, x530L-52GTX, or x530L-52GPX Switch accessory kit. Contact your Allied Telesis sales representative for assistance if any item is missing or damaged.



1 local management cable 2m (6.6 ft) with RJ-45 (8P8C) and DB-9 (D-sub 9-pin) connectors.

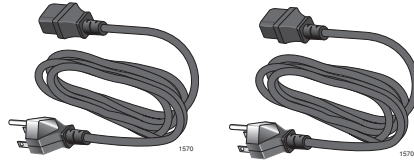

Regional AC power cords:  
2 for x530L-28GTX, x530L-52GTX, x530L-28GPX or x530L-52GPX

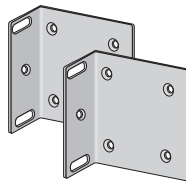

Wall/equipment rack brackets:  
2 for x530L-28GTX or x530L-52GTX  
4 for x530L-28GPX or x530L-52GPX

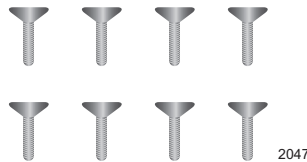

Screws to attach the wall/equipment rack brackets:  
8 for x530L-28GTX or x530L-52GTX  
16 for x530L-28GPX or x530L-52GPX  
Length: 6.0mm (0.2 in.)  
Diameter: 4.0mm (0.2 in.)

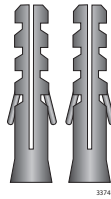

Anchors for concrete walls:  
2 for x530L-28GTX or x530L-52GTX  
4 for x530L-28GPX or x530L-52GPX  
Length: 29.6mm (1.2 in.)  
Diameter: 6.0mm (0.2 in.)

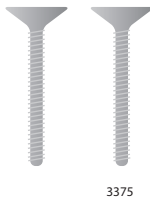

Screws for wood or concrete walls:  
2 for x530L-28GTX or x530L-52GTX  
4 for x530L-28GPX or x530L-52GPX  
Length: 32mm (1.3 in.)  
Diameter: 4mm (0.2 in.)

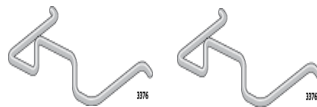

2 power cord retaining clips

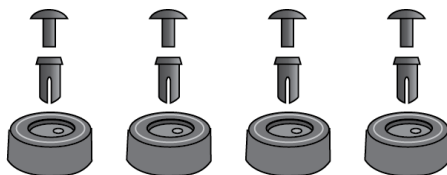

4 rubber bumper feet

Figure 40. 28- or 52-Port Accessory Kit Items

## Chapter 4

# Installing the Switch on a Table

---

This chapter contains the instructions for installing the switch on a table or desktop.



### **Warning**

Switches should not be stacked on a table or desktop. They could present a physical safety hazard if you need to move or replace switches.  E91

---



### **Warning**

The switch is heavy. Always ask for assistance when moving or lifting the device so as to avoid injuring yourself or damaging the equipment.

---

## Installing the Bumper Feet

---

The switch comes with four bumper feet in the accessory kit. The feet, which are reusable, are used when installing the switch on a table. If they are already assembled, disassemble them by removing the rivets and rivet housings from the bumper feet. Refer to Figure 41.

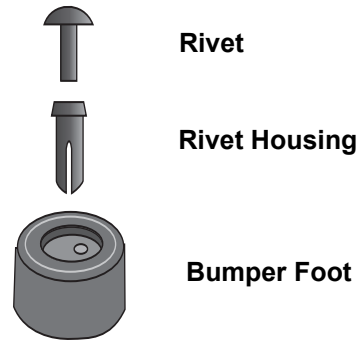

Figure 41. Parts of the Bumper Feet

The holes in the base of the switch for the bumper feet are shown in Figure 42.

---

**Note**

Although you cannot stack the switches on top of each other, they can be placed next to each other.

---

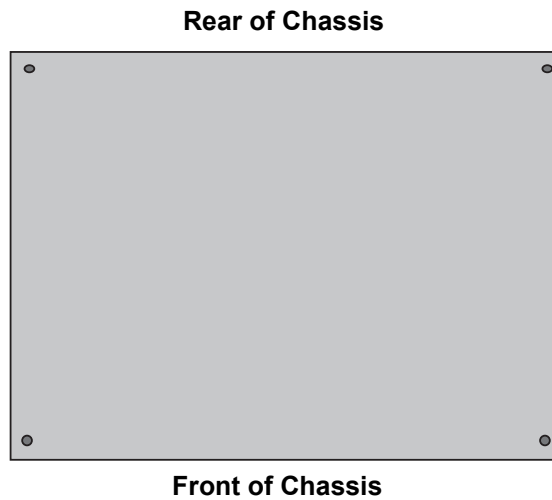

Figure 42. Holes for Bumper Feet

**Note**

The following procedure assumes that you have already reviewed the information and performed the procedures in Chapter 3, “Beginning the Installation” on page 89.

To install the switch on a table, perform the following procedure:

1. Place the switch upside down on a table.
2. Insert a rivet housing into a bumper foot. Refer to Figure 43.

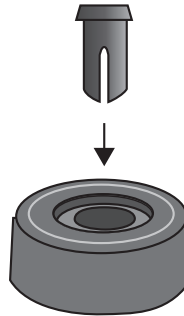

Figure 43. Inserting the Rivet Housing into the Bumper Foot

3. Place the bumper foot with rivet housing onto one of the holes in the base of the switch. Refer to Figure 44.

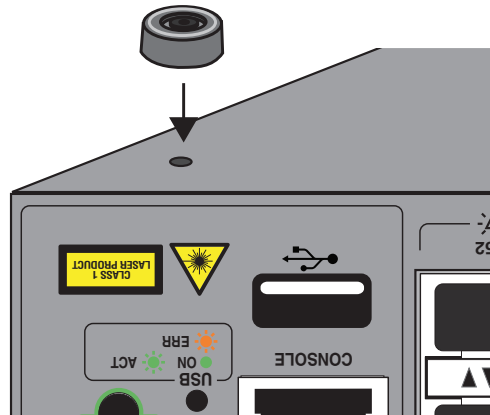

Figure 44. Placing the Bumper Foot on a Base Corner Hole

4. Insert the rivet to secure the bumper foot to the base. Refer to Figure 45 on page 106.

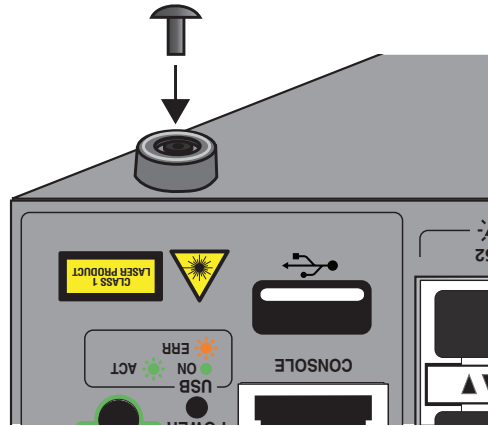

Figure 45. Inserting the Rivet into the Bumper Foot

5. Repeat steps 2 to 4 to install the remaining bumper feet.
6. Turn the switch over and place it on a flat, secure desk or table, leaving ample space around it for ventilation.
7. After installing all the switches of the stack, do one of the following:
  - To build the stack with the default stacking ports, go to Chapter 7, “Building the Trunk with the Default 10Gbps Stacking Ports” on page 141.
  - To build a stack of x530L-10GHXm and x530L-18GHXm switches using 5Gbps ports for the trunk, refer to Chapter 8, “Building the Stack Trunk with 5Gbps Multi-Speed Ports” on page 161.

## Chapter 5

# Installing the Switch in an Equipment Rack

---

This chapter provides instructions for installing the switch in an equipment rack, and contains the following sections:

- ❑ “Overview of Installing the x530L-10GHXm Switch in an Equipment Rack” on page 108
- ❑ “Installing the x530L-10GHXm Switch in an Equipment Rack with the RKMT-J14 Brackets” on page 110
- ❑ “Installing the x530L-10GHXm Switch in an Equipment Rack with the RKMT-J15 Bracket” on page 115
- ❑ “Installing the x530L-18GHXm, x530L-28GTX, x530L-28GPX, x530L-52GTX, or x530L-52GPX Switch in an Equipment Rack” on page 121

## Overview of Installing the x530L-10GHXm Switch in an Equipment Rack

---

You can install the x530L-10GHXm switch in a 19-inch equipment rack two ways. One way is with the RKMT-J14 brackets that come with the switch. Refer to Figure 46.

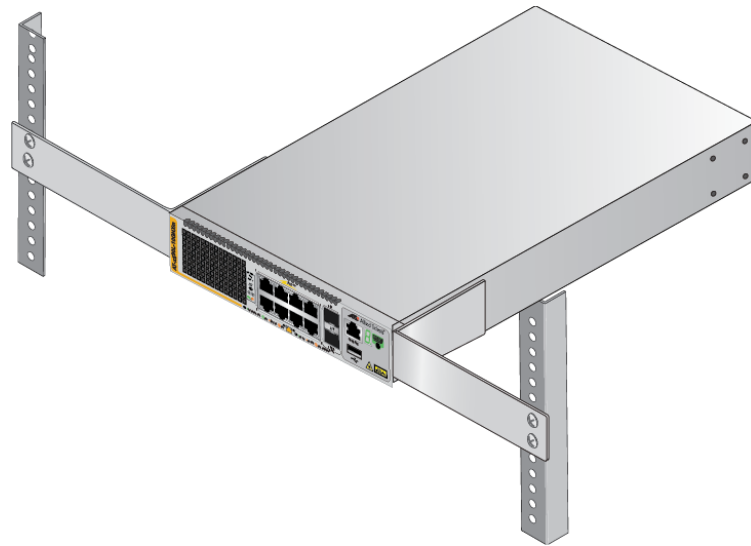

Figure 46. RKMT-J14 Brackets and Switch

For installation instructions, refer to “Installing the x530L-10GHXm Switch in an Equipment Rack with the RKMT-J14 Brackets” on page 110.

You can also install the switch in an equipment rack with the optional RKMT-J15 bracket. Refer to Figure 47.

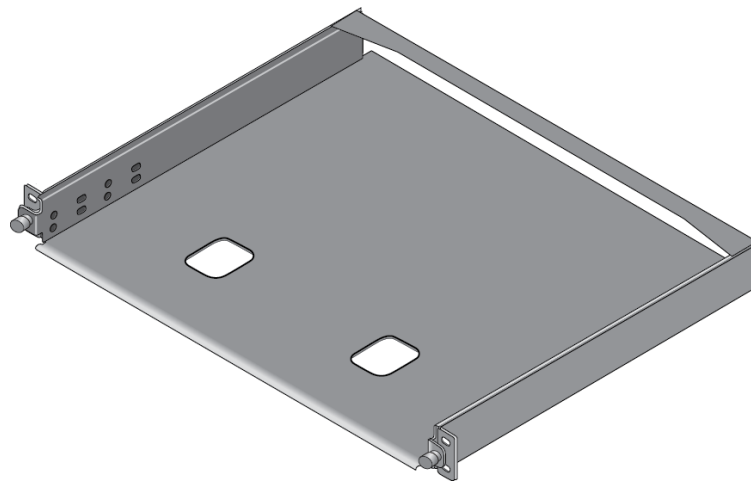

Figure 47. RKMT-J15 Bracket



The bracket lets you install two switches side-by-side. Refer to Figure 48.



Figure 48. RKMT-J15 Bracket with Switches

---

**Note**

The RKMT-J15 Bracket is purchased separately.

---

For installation instructions, refer to “Installing the x530L-10GHXm Switch in an Equipment Rack with the RKMT-J15 Bracket” on page 115.

## Installing the x530L-10GHXm Switch in an Equipment Rack with the RKMT-J14 Brackets

---

This section contains the procedure for installing the x530L-10GHXm Switch in a standard 19-inch equipment rack, with the RKMT-J14 Brackets included with the switch.

### Required Items

The following items are required to install the switch in an equipment rack with the RKMT-J14 Brackets:

- Two RKMT-J14 equipment rack brackets (included with the switch)
- Eight M4x6mm bracket screws (included with the switch)
- Four M3x6mm screws (included with the switch)
- Two bracket handles (included with the switch)
- Cross-head screwdriver (not provided)
- Four standard equipment rack screws (not provided)

### Switch Orientations in the Equipment Rack

The switch has two sets of four screw holes on the left and right sides, for attaching the RKMT-J14 Brackets. Refer to Figure 49.

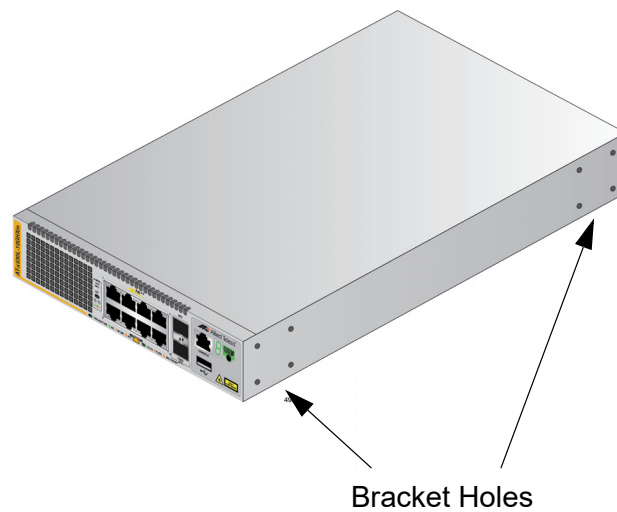

Figure 49. Bracket Holes

The brackets also have two sets of four holes. Refer to Figure 50 on page 111.

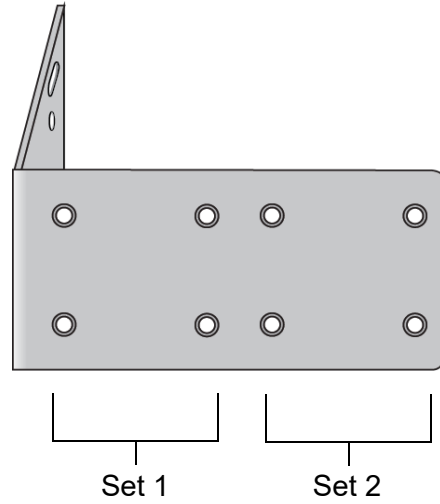

Figure 50. RKMT-J14 Bracket Holes

You can use the different sets of holes on the switch and brackets to install the switch in the equipment rack in a variety of orientations. You can install it with the front panel flush with, extending in front of, or recessed behind the front of the equipment rack. The illustrations in Figure 51 show the switch orientations with the front panel facing the front of the equipment rack.

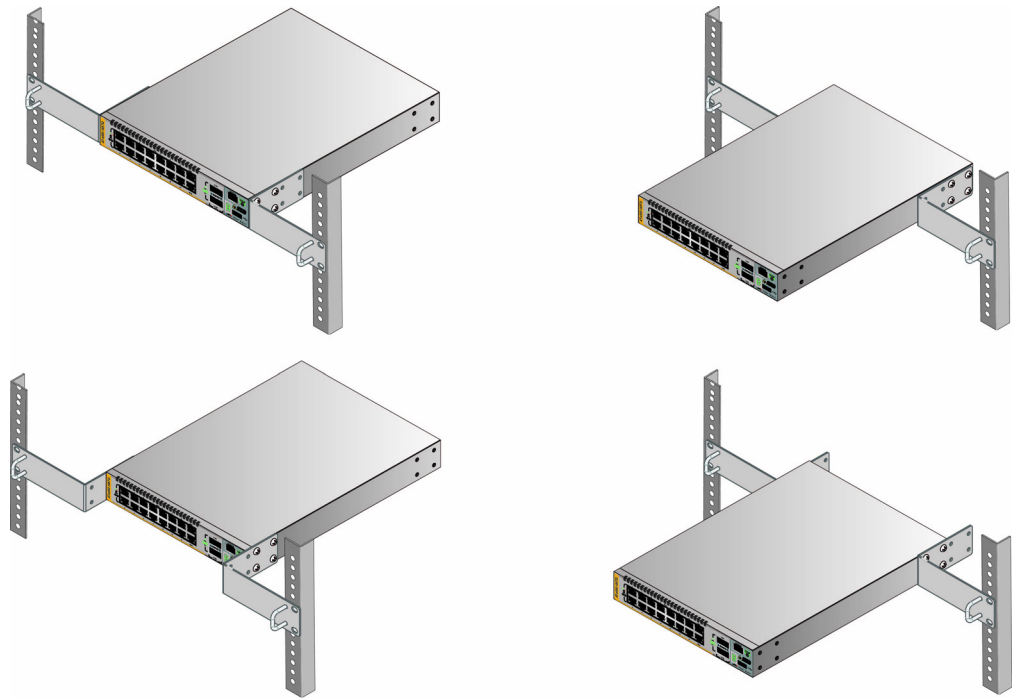

Figure 51. Switch Orientations with the Front Panel Facing the Front of the Equipment Rack

You can also orient the switch with the rear panel facing the front of the equipment rack. Refer to Figure 52.

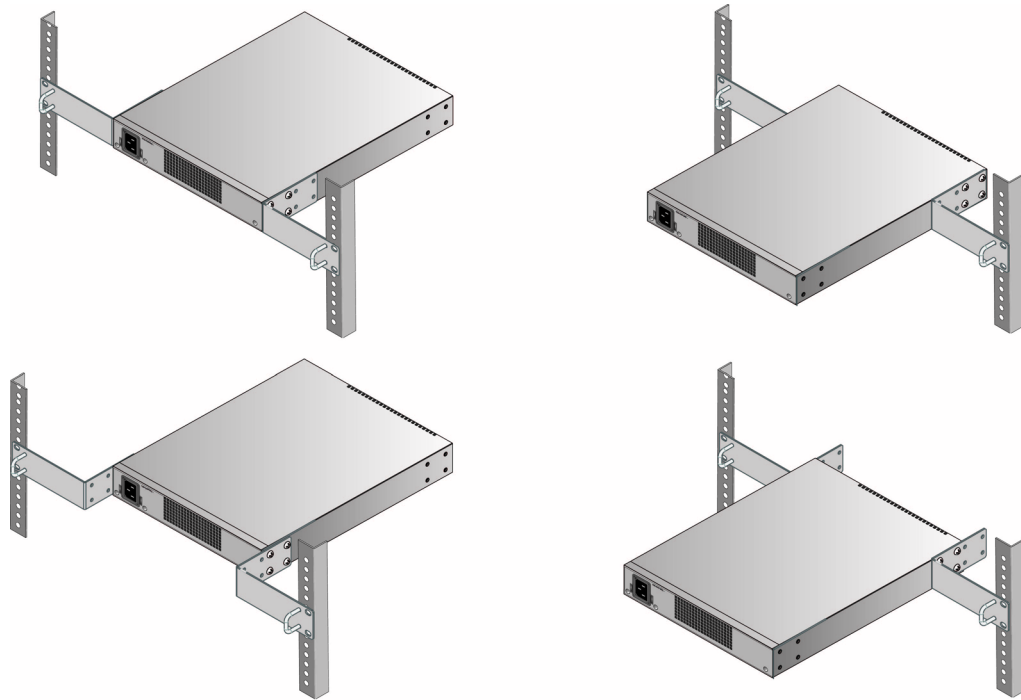

Figure 52. Switch Orientations with the Rear Panel Facing the Front of the Equipment Rack

## Installing the Switch

If you have not chosen an orientation for the switch in the equipment rack, review “Switch Orientations in the Equipment Rack” on page 110.

Please review the installation guidelines in “Choosing a Site for the Switch” on page 52 before installing the switch in an equipment rack.



### Caution

The chassis may be heavy and awkward to lift. Allied Telesis recommends that you get assistance when mounting the chassis in an equipment rack. *E28*

To install the switch in a 19-inch equipment rack with the RKMT-J14 Brackets, perform the following procedure:

1. Attach the two handles to the RKMT-J14 Brackets using the four M3x6mm screws included with the switch. Refer to Figure 53 on page 113.

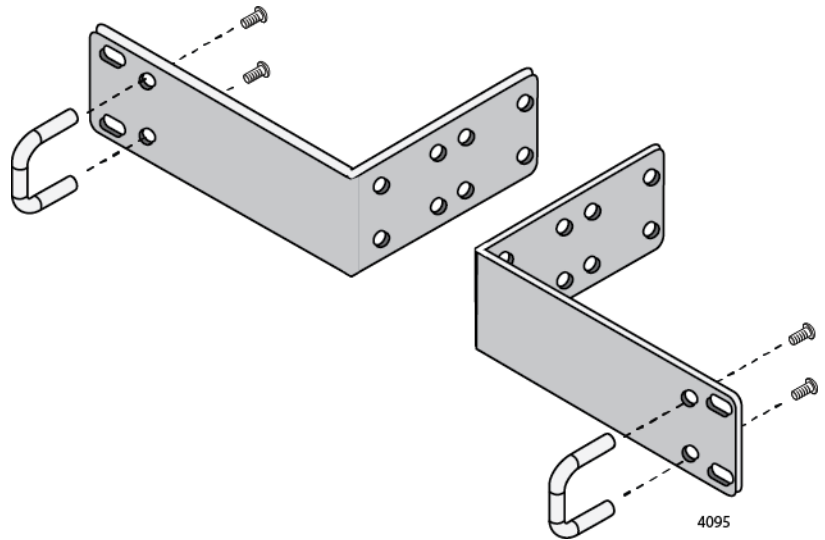

Figure 53. Attaching the Handles to the RKMT-J14 Brackets

2. Place the switch on a level, secure surface.
3. Attach the two brackets to the sides of the switch in the selected position, using the eight M4x6mm screws included with the unit. (Refer to Figure 51 on page 111 and Figure 52 on page 112.) The illustration in Figure 54 shows the installation of the brackets such that the front panel of the switch is even with the front of the equipment rack.

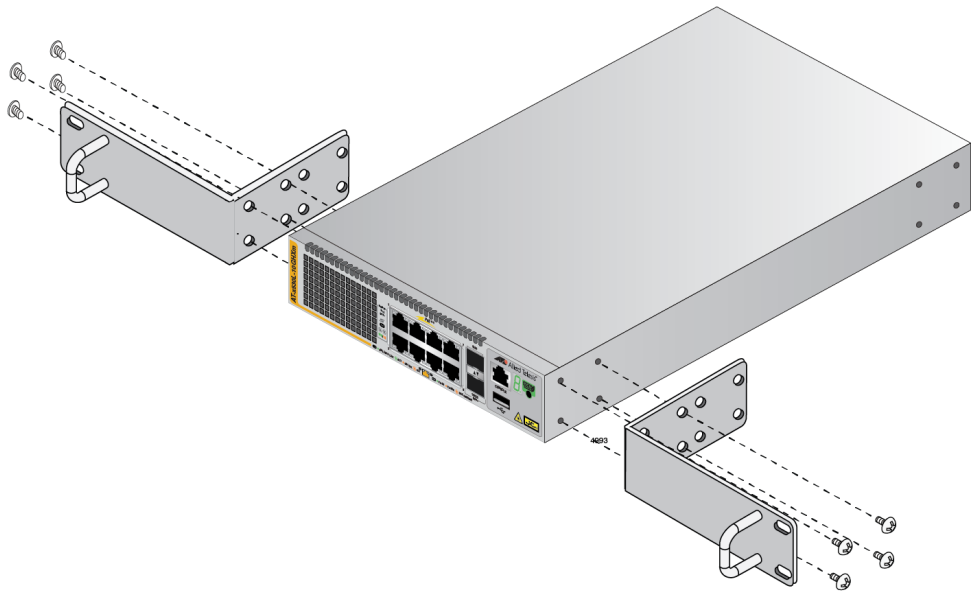

Figure 54. Attaching the RKMT-J14 Brackets to the Switch

4. Have another person hold the switch at the desired location in the equipment rack while you secure it using four standard equipment rack screws (not provided). Refer to Figure 55.

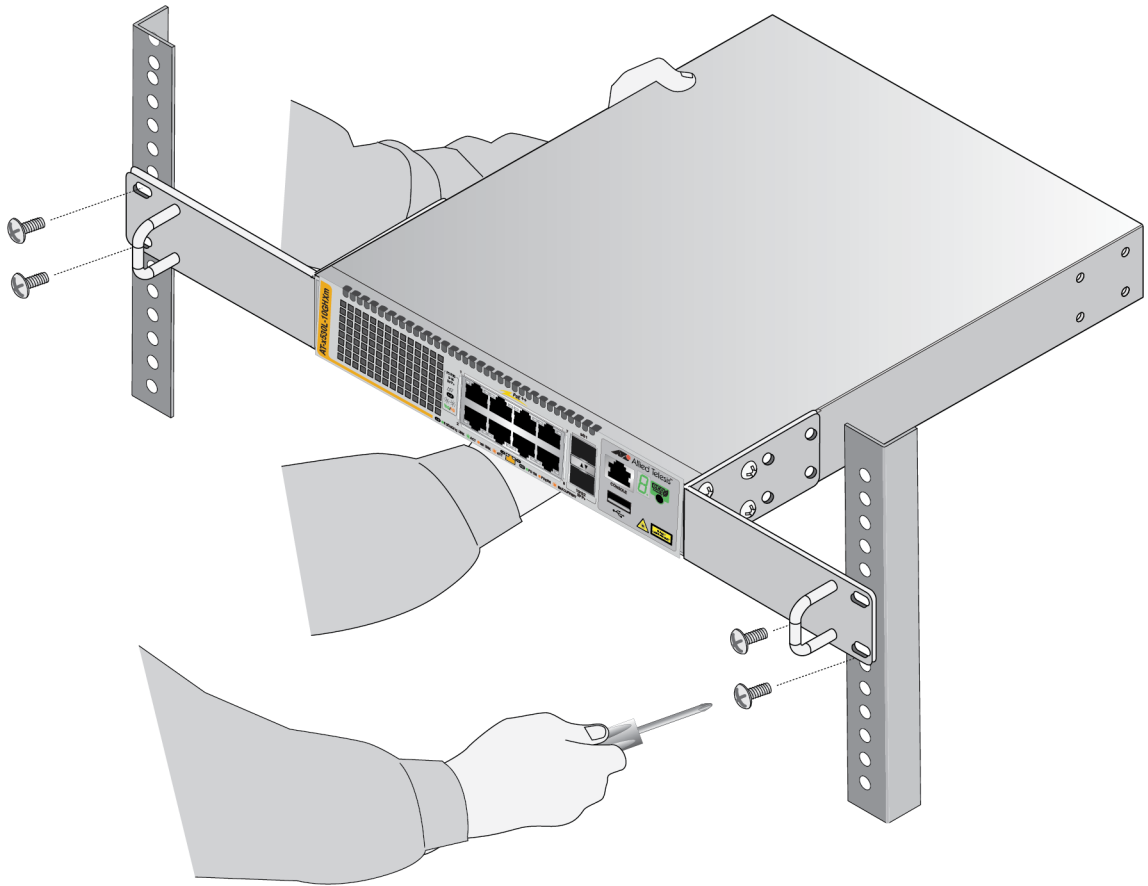

Figure 55. Installing the Switch in an Equipment Rack

5. After installing all the switches of the stack, do one of the following:
  - ❑ To build the stack with the default stacking ports, refer to Chapter 7, “Building the Trunk with the Default 10Gbps Stacking Ports” on page 141.
  - ❑ To build a stack of x530L-10GHXm or x530L-18GHXm switches using 5Gbps ports for the trunk, refer to Chapter 8, “Building the Stack Trunk with 5Gbps Multi-Speed Ports” on page 161.

## Installing the x530L-10GHXm Switch in an Equipment Rack with the RKMT-J15 Bracket

---

This section contains the procedure for installing the x530L-10GHXm switch in a standard 19-inch equipment rack, with the optional RKMT-J15 Bracket.

### Required Items

The following items are required to install the x530L-10GHXm switch in an equipment rack with the RKMT-J15 Bracket:

- One RKMT-J15 equipment rack-mount bracket (sold separately)
- Four M4x6mm bracket screws (included with the RKMT-J15)
- Cross-head screwdriver (not provided)
- Flat-head screwdriver (not provided)
- Four standard equipment rack screws (not provided)

---

#### Note

If the rubber feet have been attached to the device, remove them.

---

### Installing the Switch

To install the x530L-10GHXm switch in a 19-inch equipment rack with the RKMT-J15 Bracket, perform the following procedure:

1. Have another person hold the RKMT-J15 Bracket at the desired location in the equipment rack while you secure it using four standard equipment rack screws (not provided). Refer to Figure 56 on page 116.

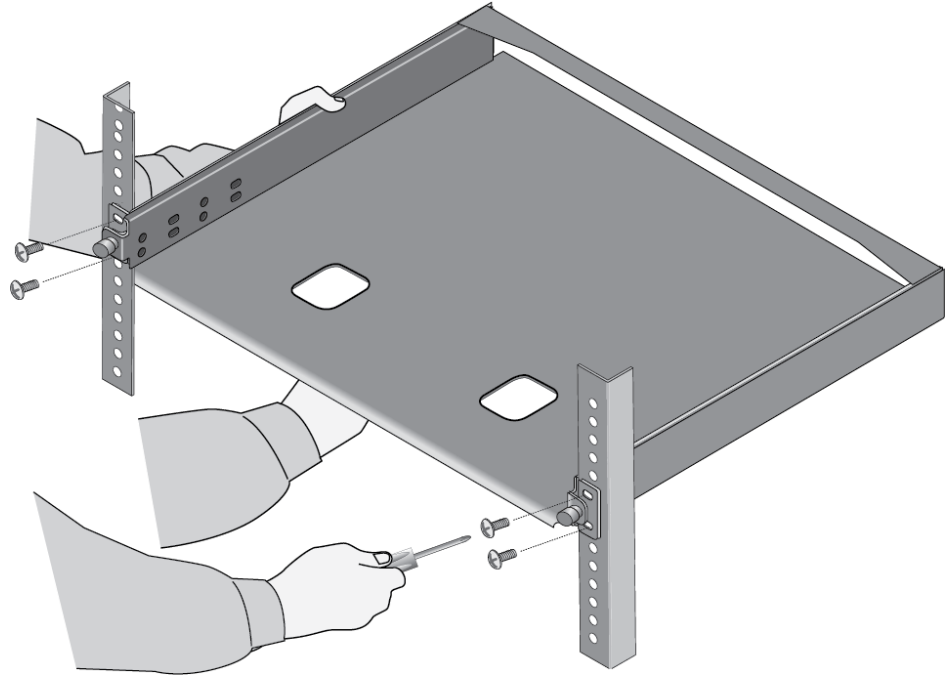

Figure 56. Installing the RKMT-J15 Bracket in the Equipment Rack

2. Loosen the two thumbscrews on the front of the bracket. Refer to Figure 57.

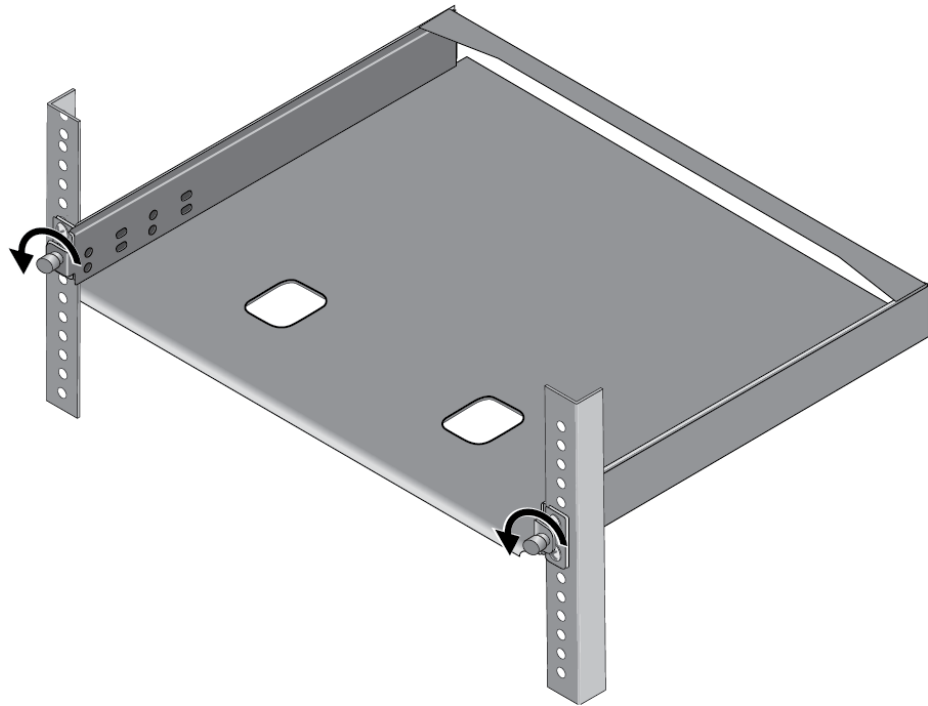

Figure 57. Loosening the Two Thumbscrews on the Front of the RKMT-J15 Bracket



3. Slide out the bracket tray. Refer to Figure 58.

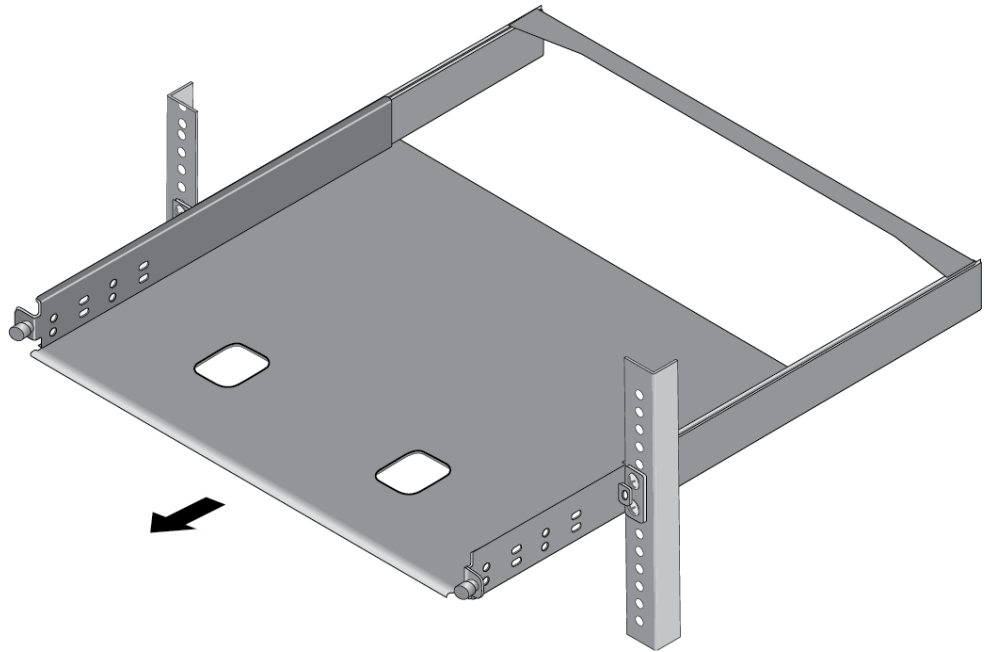

Figure 58. Sliding Out the Bracket of the RKMT-J15

---

**Note**

Follow steps 4 to 6 to remove the plastic feet from the bottom of the switch. If the plastic feet have been installed, you must remove them to install the switch in the RKMT-J15 Bracket.

---

4. Place the switch upside-down on a table.
5. Use a small flat-head screwdriver to pry the four plastic feet from the bottom of the switch. Refer to Figure 59.

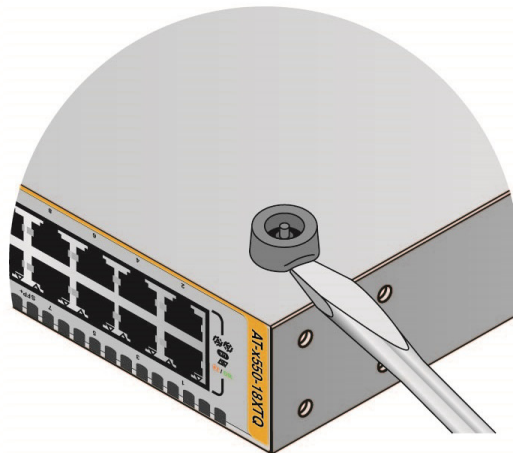

Figure 59. Removing the Plastic Feet from the Bottom Panel of the Switch

6. Turn the switch over so that it is right-side up.
7. Place the switch on one side of the bracket. Align the front panel with the front edge of the bracket. If you are installing only one switch, you may install it on either the left or right side. Refer to Figure 60.

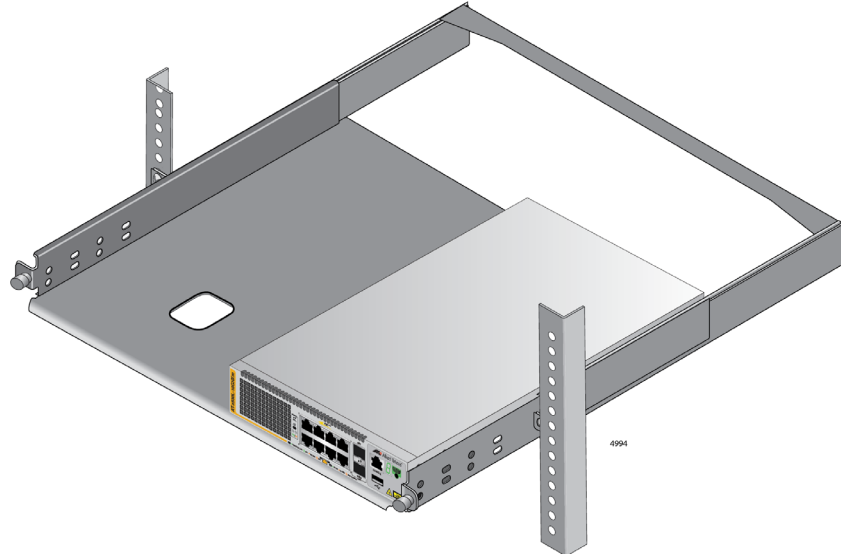

Figure 60. Placing the x530L-10GHXm Switch in the RKMT-J15 Bracket

8. Install two M4x6mm screws included with the RKMT-J15 using the first set of holes to secure the switch to the bracket. Refer to Figure 61.

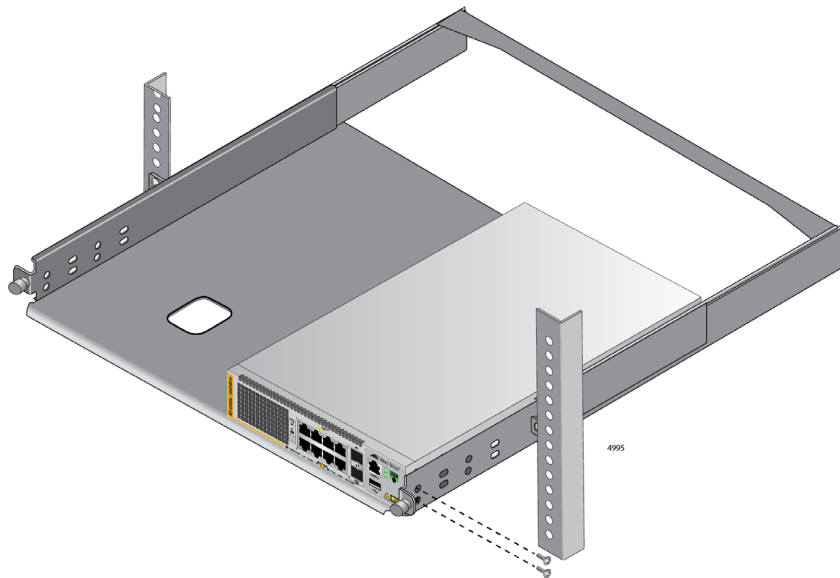

Figure 61. Securing the x530L-10GHXm Switch to the RKMT-J15 Bracket

9. To install a second switch in the bracket, repeat steps 4 to 8.

10. Slide in the bracket tray. Refer to Figure 62.

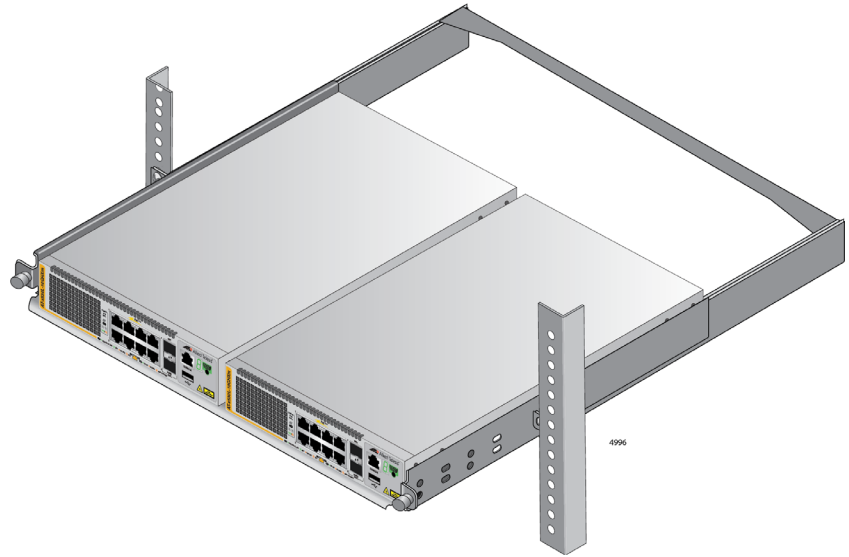

Figure 62. Sliding in the Bracket

11. Tighten the two thumbscrews to secure the bracket to the rack. Refer to Figure 63.

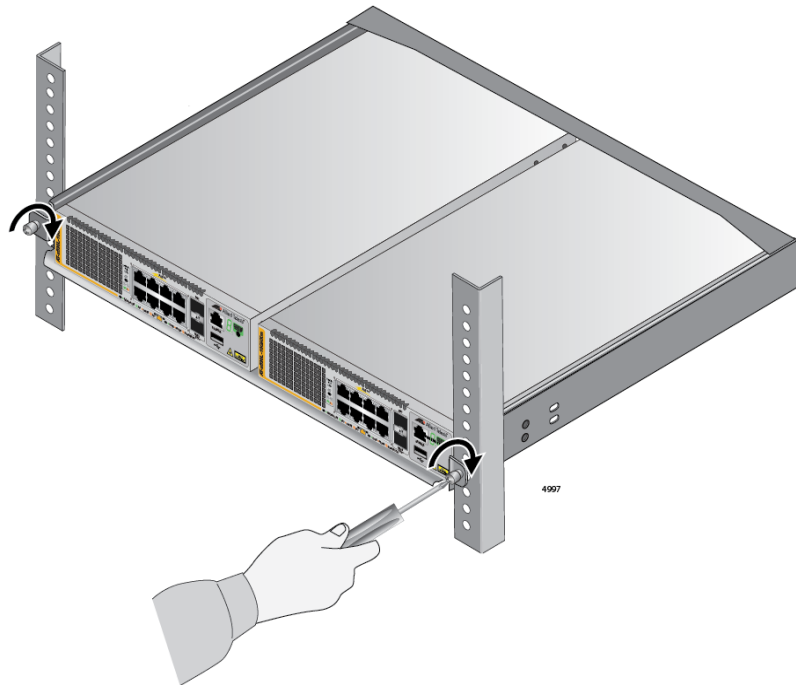

Figure 63. Tightening the Two Thumbscrews on the RKMT-J15 bracket.

12. After installing all the switches of the stack, do one of the following:

- ❑ To build the stack with the default stacking ports, refer to Chapter 7, “Building the Trunk with the Default 10Gbps Stacking Ports” on page 141.
- ❑ To build a stack of x530L-10GHXm or x530L-18GHXm switches using 5Gbps ports for the trunk, refer to Chapter 8, “Building the Stack Trunk with 5Gbps Multi-Speed Ports” on page 161.

## Installing the x530L-18GHXm, x530L-28GTX, x530L-28GPX, x530L-52GTX, or x530L-52GPX Switch in an Equipment Rack

---

This section contains the procedure for installing the x530L-18GHXm, x530L-28GTX, x530L-28GPX, x530L-52GTX, or x530L-52GPX Switch in a standard 19-inch equipment rack using the brackets supplied with the unit.

### Required Items

The following items are required to install the switch in an equipment rack:

- Two equipment rack brackets (included with the switch)
- Eight M4x6mm bracket screws (included with the switch)
- Cross-head screwdriver (not provided)
- Four standard equipment rack screws (not provided)

### Switch Orientations in the Equipment Rack

The switch has two sets of four screw holes on the left and right sides, for attaching the brackets. Refer to Figure 64.

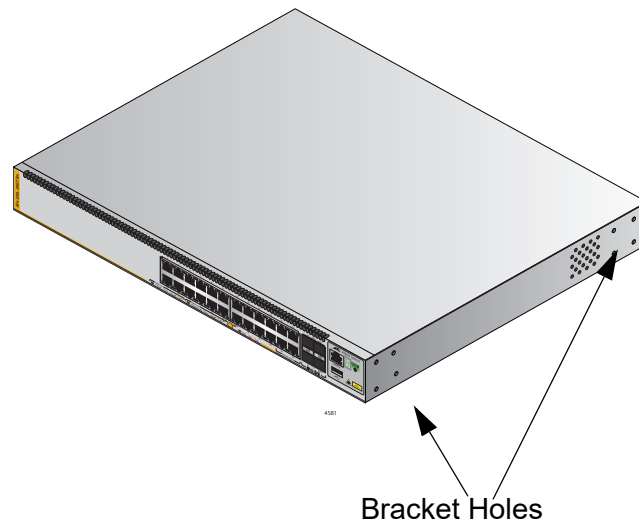

Figure 64. Bracket Holes on the Switch

You can use the different sets of holes on the switch to install the switch in the equipment rack in a variety of orientations. You can install it with the front panel flush with, extending in front of, or recessed behind the front of the equipment rack. Refer to Figure 65.



Figure 65. Switch Orientations in an Equipment Rack

## Installing the Switch

If you have not chosen an orientation for the switch in the equipment rack, review “Switch Orientations in the Equipment Rack” on page 121.

Please review the installation guidelines in “Choosing a Site for the Switch” on page 95 before installing the switch in an equipment rack.



### Caution

The chassis can be heavy and awkward to lift. Allied Telesis recommends that you get assistance when mounting the chassis in an equipment rack. *ES* E28

To install the switch in a 19-inch equipment rack, perform the following procedure:

1. Place the switch on a level, secure surface.
2. Attach the two brackets to the sides of the switch in the selected position, using the eight M4x6mm screws supplied with the unit. The illustration in Figure 66 shows the installation of the brackets such that the front panel of the switch is even with the front of the equipment rack.

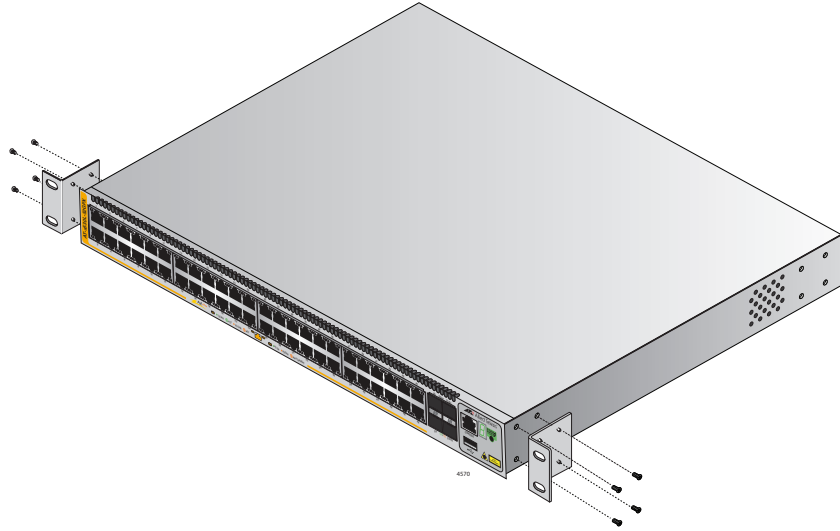

Figure 66. Example of Attaching the Brackets to the Switch

3. Have another person hold the switch at the desired location in the equipment rack while you secure it using four standard equipment rack screws (not provided). Refer to Figure 67.

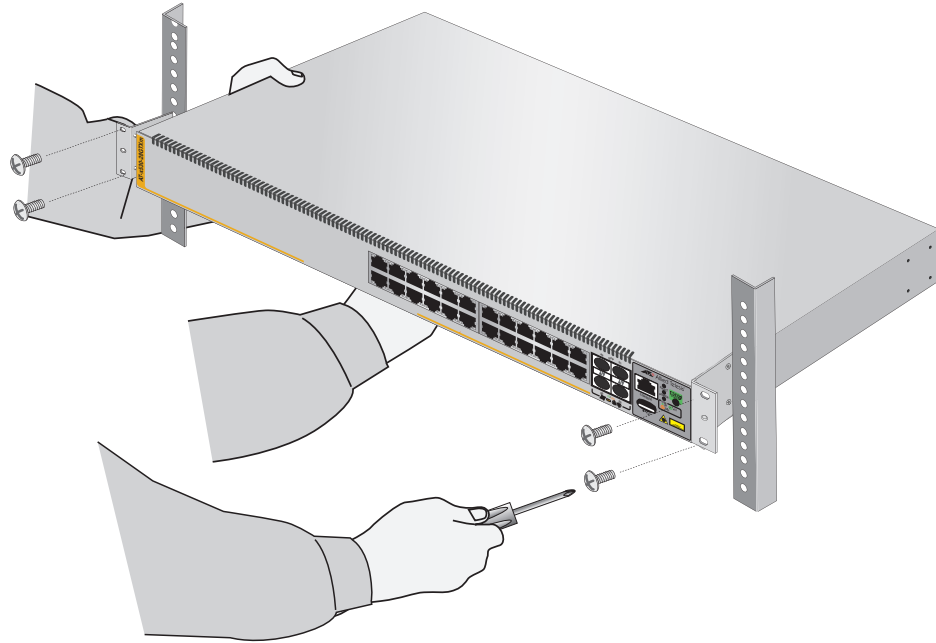

Figure 67. Installing the Switch in an Equipment Rack

4. After installing all the switches of the stack:
  - ❑ To build the stack with the default stacking ports, refer to Chapter 7, “Building the Trunk with the Default 10Gbps Stacking Ports” on page 141.
  - ❑ To build a stack of x530L-10GHXm or x530L-18GHXm switches using 5Gbps ports for the trunk, refer to Chapter 8, “Building the Stack Trunk with 5Gbps Multi-Speed Ports” on page 161.



## Chapter 6

# Installing the Switch on a Wall

---

The procedures in this chapter are listed here:

- ❑ “Switch Orientations on a Wall” on page 126
- ❑ “Installation Guidelines” on page 127
- ❑ “Plywood Base for a Wall with Wooden Studs” on page 131
- ❑ “Installing a Plywood Base” on page 132
- ❑ “Installing the Switch on a Plywood Base” on page 133
- ❑ “Installing the Switch on a Concrete Wall” on page 137

## Switch Orientations on a Wall

---

Install the switch on a wall with the front panel facing up, left or right as shown in Figure 68. Do not install the switch with the front panel facing down.

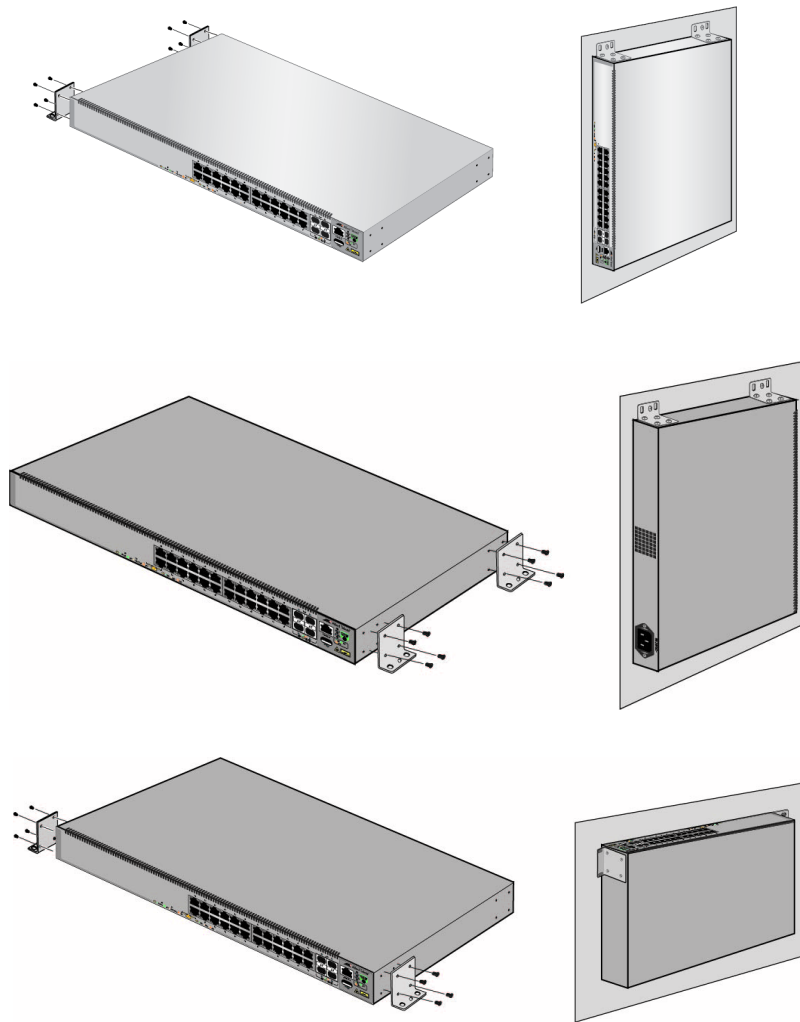

Figure 68. Switch Orientations on a Wall

## Installation Guidelines

---

Here are the guidelines for installing the switch on a wall:

- ❑ You can install the switches on a wall with the front panels facing up, left, or right. Do not install the switches with the front panels facing down.
- ❑ Install the switch on a wall that has wooden studs or on a concrete wall.
- ❑ If you are installing the switch on a wall with wooden studs, use a plywood base to support the switch. For more information, refer to “Plywood Base for a Wall with Wooden Studs” on page 131. A plywood base is not required for a concrete wall.
- ❑ Do not install the switch on a wall that has metal studs. Metal studs may not be strong enough to safely support the device.
- ❑ Do not install the switch on sheetrock or similar material. Sheetrock is not strong enough to safely support the device.



### Warning

The device is heavy. Always ask for assistance before moving or lifting it to avoid injuring yourself or damaging the equipment.

---



### Warning

The device should be installed on a wall by a qualified building contractor. Serious injury to yourself or others or damage to the equipment can result if it is not properly fastened to the wall. *ES*  
E105

---

## Tools and Material

Here are the requirements for installing the switches on a wall:

- ❑ The x530L-10GHXm Switch requires the four BRKT-J24 wall brackets and sixteen screws included with the switch.
- ❑ The x530L-28GPX, x530L-28GTX, x530L-52GPX, and x530L-52GTX Switches require the two wall/equipment rack brackets and eight screws included with the switches.
- ❑ Two or four wood or concrete wall screws (included with the switch)
- ❑ Two or four concrete wall anchors (included with the switch)
- ❑ Cross-head screwdriver (not provided)
- ❑ Flat-head screwdriver (not provided)

- ❑ Stud finder for a wooden wall, capable of identifying the middle of wall studs and hot electrical wiring (not provided)
- ❑ Drill and 1/4" carbide drill bit for a concrete wall (not provided)



**Caution**

The supplied screws and anchors might not be appropriate for all walls. A qualified building contractor can determine the hardware requirements for your wall prior to installing the switch.  E88

To install the switch on a wall, perform the following procedure:

1. Place the switch on a table.
2. If the bumper feet are attached to the bottom of the switch, remove them using a flat-head screwdriver.
3. For the x530L-10GHXm Switch, attach the four BRKT-J24 wall brackets with sixteen screws to the sides of the switch as shown in Figure 69.

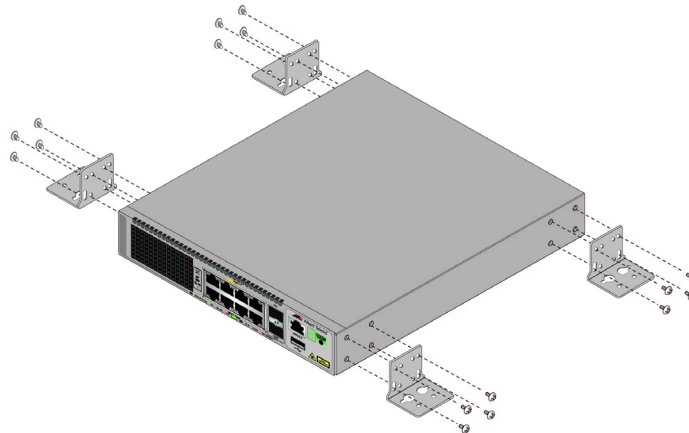

Figure 69. Attaching Wall Brackets to the x530L-10GHXm

4. For the x530L-28GTX, x530L-28GPX, x530L-52GTX, and x530L-52GPX Switches, attach the two wall/equipment rack brackets with eight screws to the sides of the switch. Refer to Figure 70 on page 129.

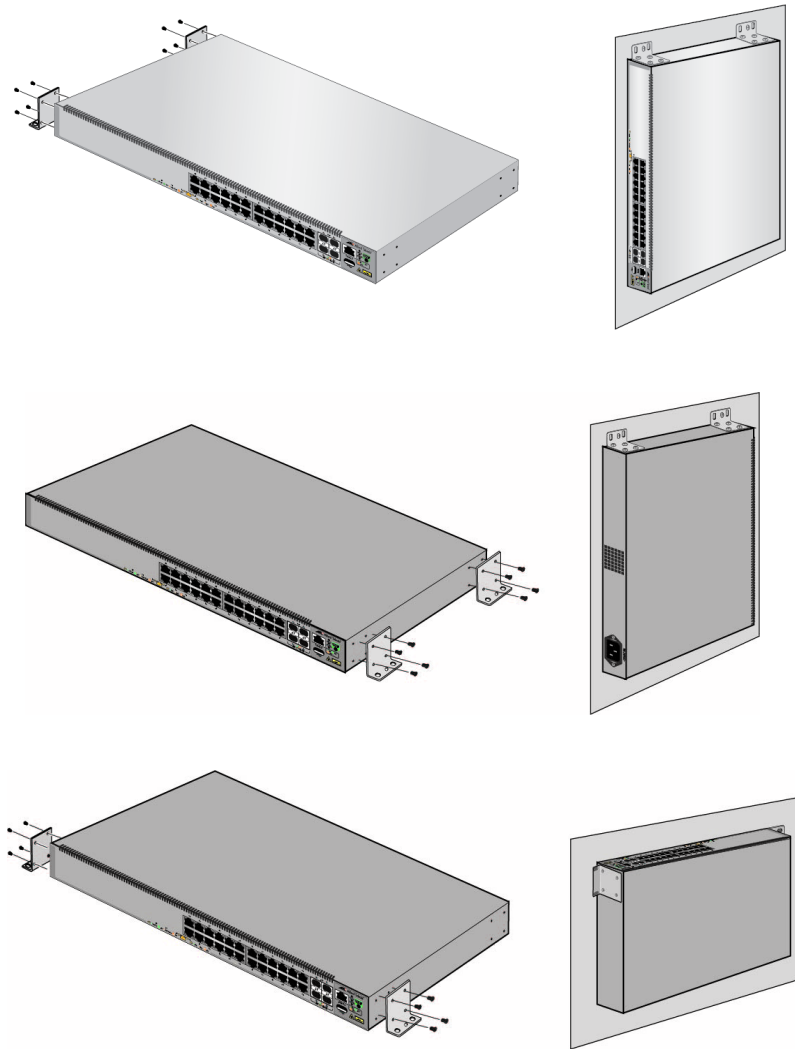

Figure 70. Attaching Wall Brackets to x530L-28GTX, x530L-28GPX, x530L-52GTX, and x530L-52GPX Switches

---

**Note**

If the wall material requires pre-drilled holes, perform steps 5 to 9. Otherwise, go to step 10.

---

5. Have another person hold the switch on the concrete wall at the selected location for the device while you use a pencil or pen to mark the wall with the locations of the screw holes in the brackets. Refer to Figure 71 on page 130.

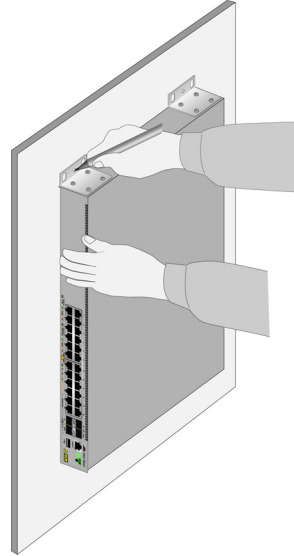

Figure 71. Marking the Screw Holes

6. Place the switch on a table or desk.
7. Use the stud finder to check for hot electrical wires at the locations of the screw holes.



---

**Warning**

Do not install the switch on a wall near hot electrical wires.

---

8. If the wall material requires pre-drilling the screw holes, use a drill to drill the holes. The dimensions of the supplied screws and anchors are in “Unpacking the x530L-10GHXm Switch” on page 96 and “Unpacking the x530L-18GHXm Switch” on page 99.
9. If the wall material requires anchors, insert the anchors into the screw holes.
10. Have another person hold the switch at the selected wall location while you secure it to the wall with appropriate screws.
11. After installing all the switches of the stack, do one of the following:
  - ❑ To build the stack with the default stacking ports, go to Chapter 7, “Building the Trunk with the Default 10Gbps Stacking Ports” on page 141.
  - ❑ To build a stack of x530L-10GHXm switches using 5Gbps ports for the trunk, refer to Chapter 8, “Building the Stack Trunk with 5Gbps Multi-Speed Ports” on page 161.

## Plywood Base for a Wall with Wooden Studs

If you are installing the switch on a wall that has wooden studs, use plywood base for the device. (A plywood base is not required for a concrete wall.) Refer to Figure 72.

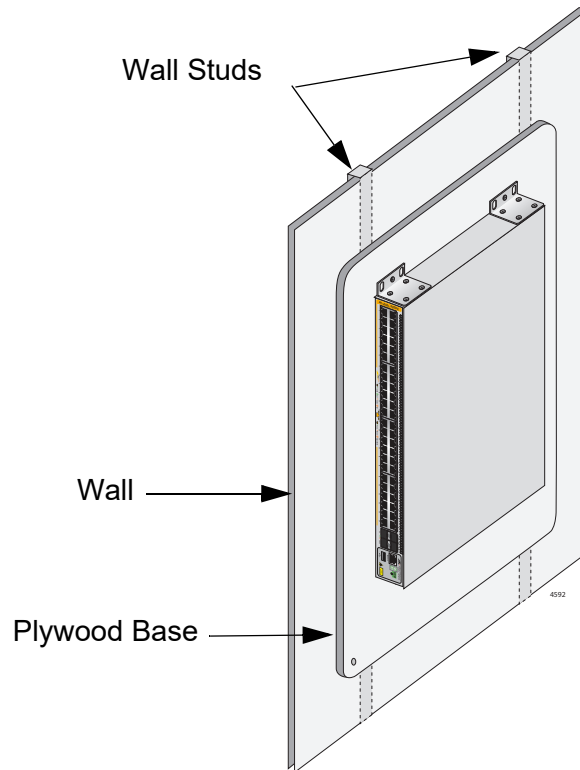

Figure 72. Switch on the Wall with a Plywood Base

Mount the plywood base to two studs in the wall. The recommended minimum dimensions of the plywood base for the switch are:

- ❑ Width: 55.9 centimeters (22 inches)
- ❑ Height: 61.0 centimeters (24 inches)
- ❑ Thickness: 2.5 centimeters (1 inch)

The dimensions assume the wall studs are 41 centimeters (16 inches) apart. You might need to adjust the width of the base if the distance between the studs in your wall is different than the industry standard.

## Installing a Plywood Base

---

A plywood base is recommended when installing the switch on a wall that has wooden studs. Refer to Figure 73. Consult a qualified building contractor for installation instructions for the plywood base. The installation guidelines are listed here:

- ❑ Use a stud finder to identify the middle of studs and hot electrical wiring in the wall.
- ❑ Attach the base to two wall studs with a minimum of four screws.
- ❑ The selected wall location for the base must provide sufficient space from other devices or walls so that you can access the front and back panels, and for adequate air flow for ventilation.

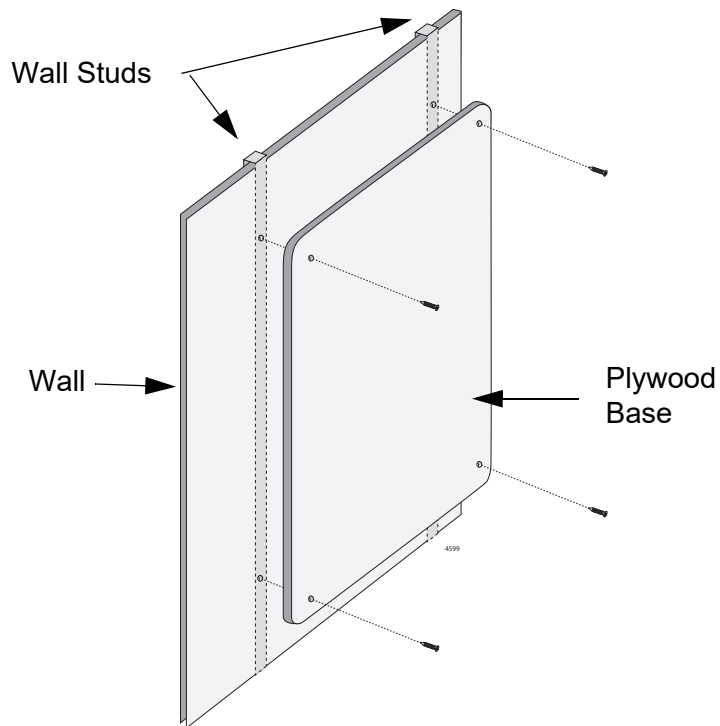

Figure 73. Installing the Plywood Base to the Wall



## Installing the Switch on a Plywood Base

---

After the plywood base for the switch has been installed on the wall, install the switch. See “Reviewing Safety Precautions” on page 90 and “Choosing a Site for the Switch” on page 95 before performing this procedure. Allied Telesis recommends a minimum of two people for this procedure.

**Warning**

The device is heavy. Always ask for assistance before moving or lifting it to avoid injuring yourself or damaging the equipment.

---

**Warning**

The device should be installed on the wall by a qualified building contractor. Serious injury to yourself or others or damage to the equipment can result if it is not properly fastened to the wall. *ES*  
E105

---

To install the switch on the plywood base, perform the following procedure:

1. Place the switch on a table.
2. For the x530L-28GPX, x530L-28GTX, x530L-52GPX, or x530L-52GTX, install two wall/equipment rack brackets to the sides of the unit with the eight M4x6mm screws included with the switch. Install the brackets on the same side of the switch. Refer to Figure 74 on page 134 for the x530L-10GHXm, install four wall/equipment rack brackets to the sides of the unit with the sixteen M4x6mm screws included with the switch. Refer to Figure 75 on page 134.

Brackets positions to install the switch with the front panel on the left.

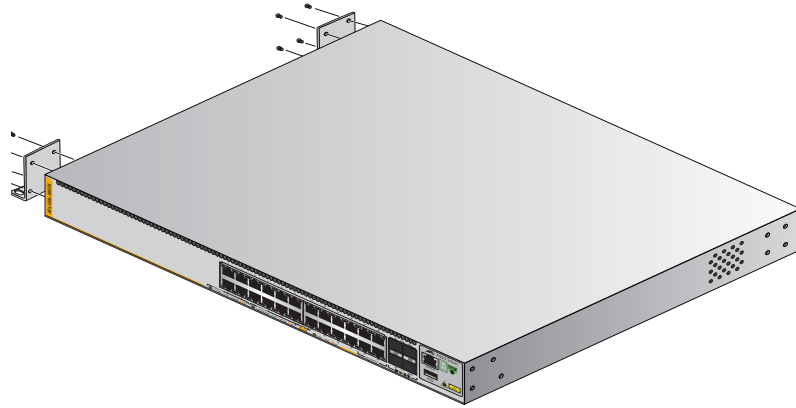

Brackets positions to install the switch with the front panel on the right.

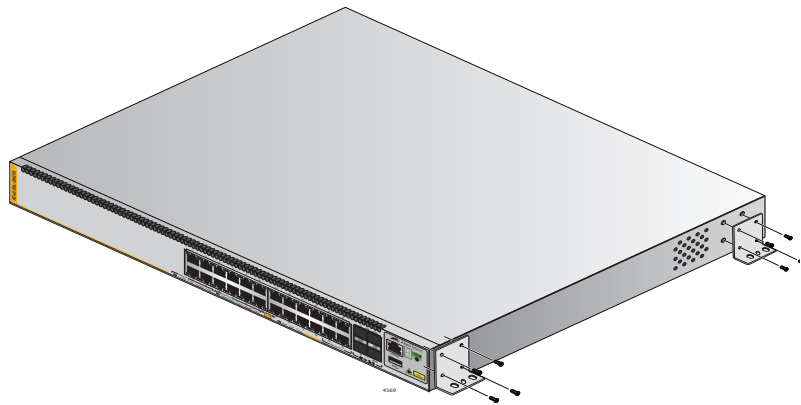

Figure 74. Installing Two Brackets on the x530L-28GPX, x530L-28GTX, x530L-52GPX, or x530L-52GTX Switch

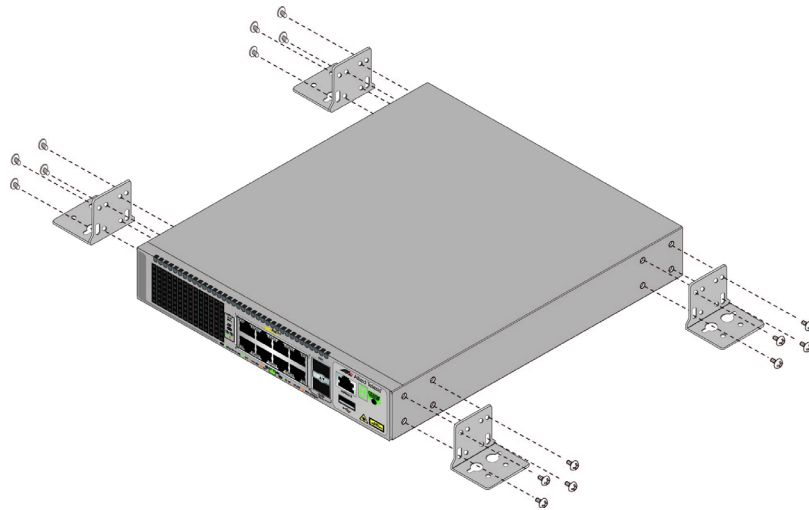

Figure 75. Installing Four Brackets on the x530L-10GHXm

3. After attaching the brackets, have another person hold the switch on the plywood base on the wall while you secure it with the M4x32.3mm screws included with the switch. Refer to Figure 76 for the x530L-28GPX, x530L-28GTX, x530L-52GPX, or x530L-52GTX switch or Figure 77 on page 136 for the x530L-10GHXm switch.

Follow these guidelines as you position the switch on the wall:

- ❑ Position the switch so that the front panel is facing up, left or right. Refer to Figure 76. Do not install it with the front panel facing down.
- ❑ Provide sufficient space from other devices or walls so that you can access the front and back panels, and for adequate air flow for ventilation.

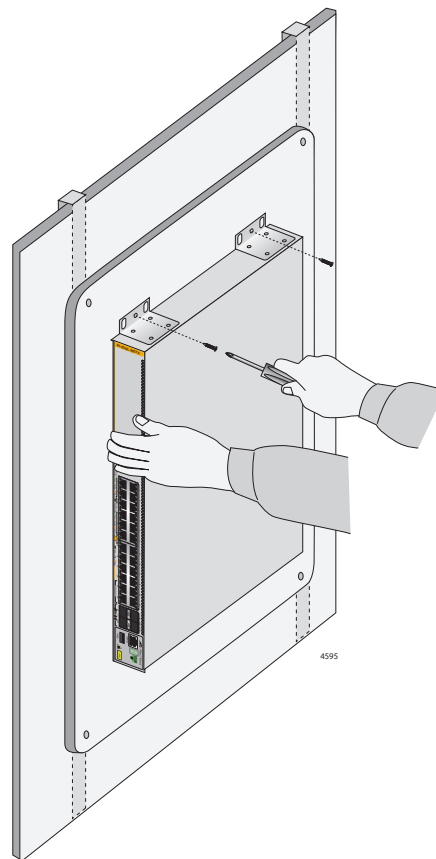

Figure 76. Securing the x530L-28GPX, x530L-28GTX, x530L-52GPX, or x530L-52GTX or x530L-52GTX Switch to the Plywood Base

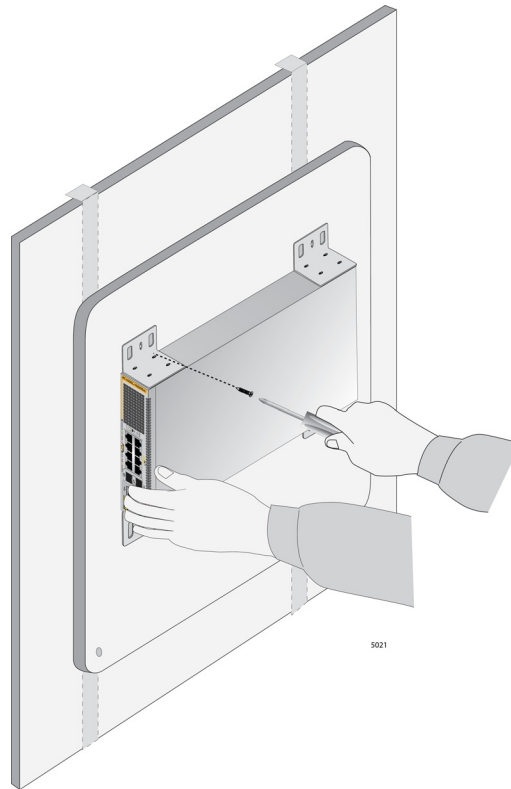

Figure 77. Securing the x530L-10GHXm Switch to the Plywood Base

4. After installing all the switches of the stack, do one of the following:
  - ❑ To build the stack with the default stacking ports, go to Chapter 7, “Building the Trunk with the Default 10Gbps Stacking Ports” on page 141.
  - ❑ To build a stack of x530L-10GHXm switches using 5Gbps ports for the trunk, refer to Chapter 8, “Building the Stack Trunk with 5Gbps Multi-Speed Ports” on page 161.

## Installing the Switch on a Concrete Wall

---

This section contains the instructions for installing the switch on a concrete wall. Please review the information in the following sections before performing the procedure:

- ❑ “Switch Orientations on a Wall” on page 126
- ❑ “Installation Guidelines” on page 127



---

### Warning

The device is heavy. Always ask for assistance before moving or lifting it to avoid injuring yourself or damaging the equipment.

---



---

### Warning

The device should be installed on the wall by a qualified building contractor. Serious injury to yourself or others or damage to the equipment can result if it is not properly fastened to the wall. *ES*  
E105

---

To install the switch on a concrete wall, perform the following procedure:

1. Place the switch on a table.
2. For the x530L-28GTX, x530L-52GTX, x530L-28GPX or x530L-52GPX switch, install two wall/equipment rack brackets to the sides of the unit with the eight M4x6mm screws included with the switch. Install the brackets same side of the switch. Refer to Figure 74 on page 134. For the x530L-10GHXm switch, install four wall/equipment rack brackets to the sides of the unit with the 16 M4x6mm screws included with the switch. Refer to Figure 75 on page 134.
3. After attaching the brackets, have another person hold the switch on the concrete wall at the selected location for the device while you use a pencil or pen to mark the wall with the locations of the screw holes in the brackets (one screw per bracket). Refer to Figure 78 on page 138.

Follow these guidelines as you position the switch on the wall:

- ❑ Position the switch so that the front panel is facing up, left or right. Refer to Figure 77 on page 136. Do not install the switch with the front panel facing down.
- ❑ Provide sufficient space from other devices or walls so that you can access the front and back panels, and for adequate air flow and ventilation.

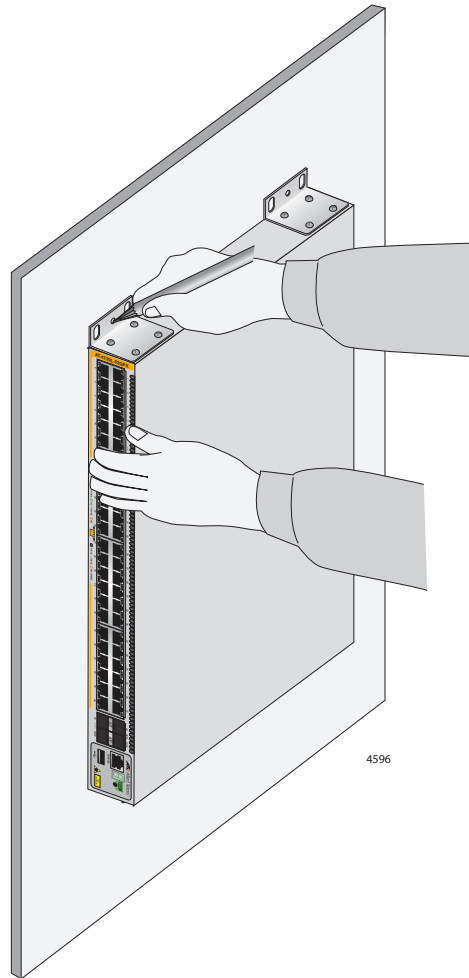

Figure 78. Marking the Locations of the Bracket Holes on a Concrete Wall

4. Place the switch on a table.
5. Use a drill and a 1/4-inch carbide drill bit to pre-drill the holes you marked in step 3. Please review the following guidelines:
  - Prior to drilling, set the drill to hammer and rotation mode. The modes break up the concrete and clean out the hole.
  - Clean out the holes with a brush or compressed air.
6. Insert the anchors into the holes.

7. Have another person hold the switch at the selected wall location while you secure it to the wall with the M4x32mm screws provided. Refer to Figure 79.

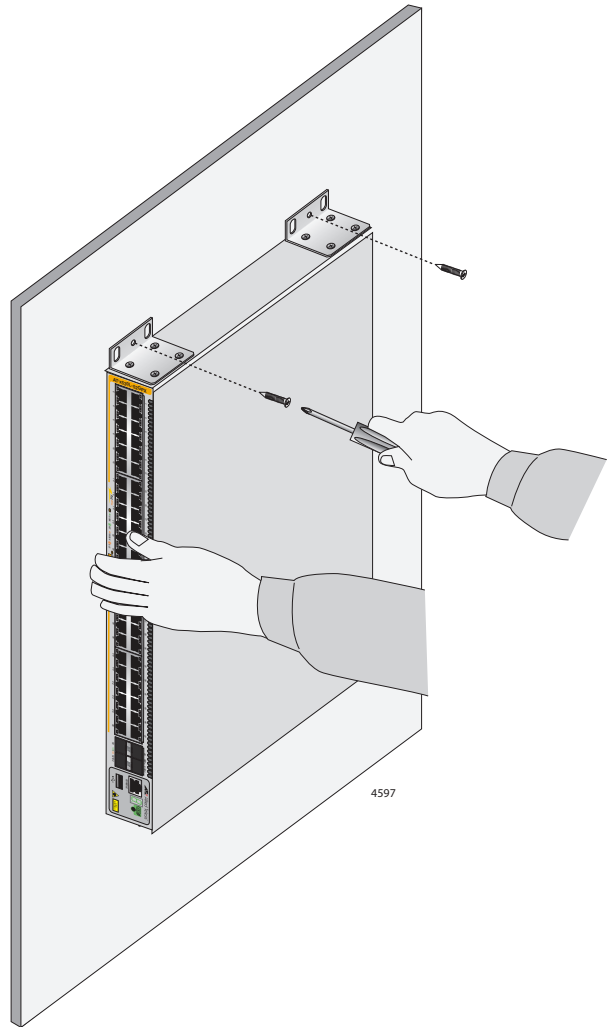

Figure 79. Installing the Switch on a Concrete Wall

8. After installing all the switches of the stack, do one of the following:
  - ❑ To build the stack with the default stacking ports, go to Chapter 7, “Building the Trunk with the Default 10Gbps Stacking Ports” on page 141.
  - ❑ To build a stack of x530L-10GHXm switches using 5Gbps ports for the trunk, refer to Chapter 8, “Building the Stack Trunk with 5Gbps Multi-Speed Ports” on page 161.





## Chapter 7

# Building the Trunk with the Default 10Gbps Stacking Ports

---

This chapter contains the following procedures:

- ❑ “Introduction” on page 142
- ❑ “Installing the Power Cord Retaining Clip(s)” on page 143
- ❑ “Powering On the Switches Individually” on page 144
- ❑ “Powering On the Switches Simultaneously” on page 148
- ❑ “Starting a Local Management Session” on page 150
- ❑ “Verifying the Stack” on page 153
- ❑ “Adding Ports 25 and 26 on the x530L-28GPX or x530L-28GTX Switch to the Stack Trunk” on page 154
- ❑ “Adding Ports 49 and 50 on the x530L-52GPX or x530L-52GTX Switch to the Stack Trunk” on page 156
- ❑ “Monitoring the Initialization Processes” on page 158

## Introduction

---

This chapter contains instructions for building the stack using the default 10Gbps stacking ports. The procedure does not require any configuration steps because the stacking feature is enabled by default. The default stacking ports are:

- ❑ Ports 9 and 10 on the x530L-10GHXm
- ❑ Ports 17 and 18 on the x530L-18GHXm
- ❑ Ports 27 and 28 on the x530L-28GPX and x530L-28GTX
- ❑ Ports 51 and 52 on the x530L-52GPX and x530L-52GPX

To build the stack, you cable the stacking ports and power on the switches.

There are two procedures:

- ❑ To control the assignment of the switch ID numbers yourself, perform “Powering On the Switches Individually” on page 144. The numbers are assigned in the order in which you power on the units.
- ❑ To have the switches assign the ID numbers automatically, perform “Powering On the Switches Simultaneously” on page 148.

After the ID numbers are assigned, you may change them with the STACK RENUMBER command, described in the *Command Reference for x530 Series Switches, AlliedWare Plus Operating System*.



### Caution

Do not change the ID numbers of the switches after beginning to configure the parameter settings. Otherwise, the stack might assign configuration settings to the wrong units.

---

### Note

To build a stack of x530L-10GHXm or x530L-18GHXm switches using the 5Gbps multi-speed ports for the stack trunk instead of the default ports, refer to Chapter 8, “Building the Stack Trunk with 5Gbps Multi-Speed Ports” on page 161. For background information, refer to “Stack Trunks” on page 61.

---

## Installing the Power Cord Retaining Clip(s)

The power cord retaining clips that come with the switch protect the power cords from being accidentally unplugged from the unit.

1. To install a power cord retaining clip, position it the “u” part facing down, press in the sides, and insert the ends of the clip into the holes in the retaining bracket on the AC connector on the switch. Refer to Figure 80.

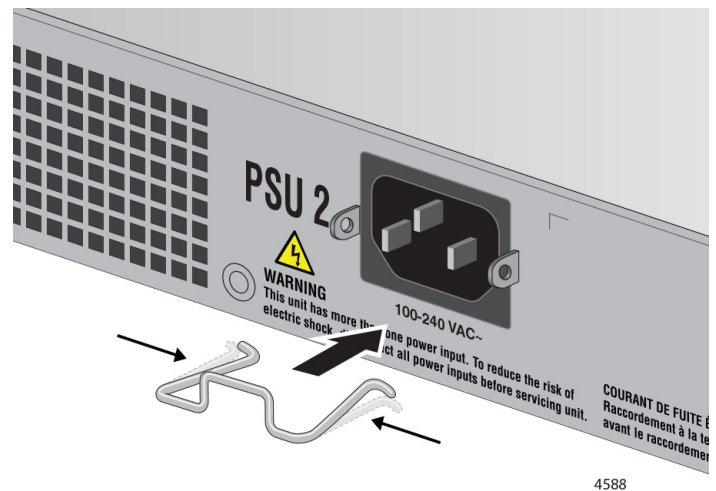

Figure 80. Installing the Retaining Clip

2. Go to either “Powering On the Switches Individually” on page 144 or “Powering On the Switches Simultaneously” on page 148.

## Powering On the Switches Individually

---

This procedure explains how you can control the assignment of the ID numbers of the switches by powering on the units one at a time during the initial power-on sequence. The first switch is assigned ID number 1, the next unit is assigned ID number 2, and so on. This procedure is useful when the switches are installed in the same equipment rack and you want to number them in sequence, such as from top to bottom, to make them easier to identify. After the ID numbers are assigned, the switches retain their assignments even if you power off or reset the stack.

During the first power on sequence, the first switch to be powered on becomes the master switch of the stack. However, if you do not change the priority values of the units, the next time you reset or power cycle the stack the units use their MAC addresses to select the master switch. This might result in a different switch being assigned that role. However, this does not affect their ID number assignments, the configuration of the switches, or the manner in which you manage the stack.

This procedure assumes the following:

- This is the initial power-on sequence of the stack.
- You cabled ports on the switches to form the stack trunk:
  - x530L-10GHXm ports 9 and 10
  - x530L-18GHXm ports 17 and 18
  - x530L-28GPX and x530L-28GTX ports 27 and 28
  - x530L-52GPX and x530L-52GTX ports 51 and 52
- The ID numbers are set to the default 1.
- All the switches are powered off.

If you want to monitor the power on sequence, you can connect a terminal or computer with a terminal emulator program to the Console port on the switch you intend to power on first. The messages are found in “Monitoring the Initialization Processes” on page 158.

Before powering on the switch, refer to “Power Specifications” on page 221 for the power specifications.

To power on the stack for the first time and control the assignment of the ID numbers, perform the following procedure:

1. If you have not already cabled the default trunk ports do so now. For background information, refer to “Stack Trunks” on page 61, For cabling instructions, refer to Chapter 9, “Cabling the Networking Ports” on page 203.

2. Power on the switch you want to be assigned ID number 1 by connecting its power cord to the AC connector on the back panel. Refer to Figure 82 on page 145.

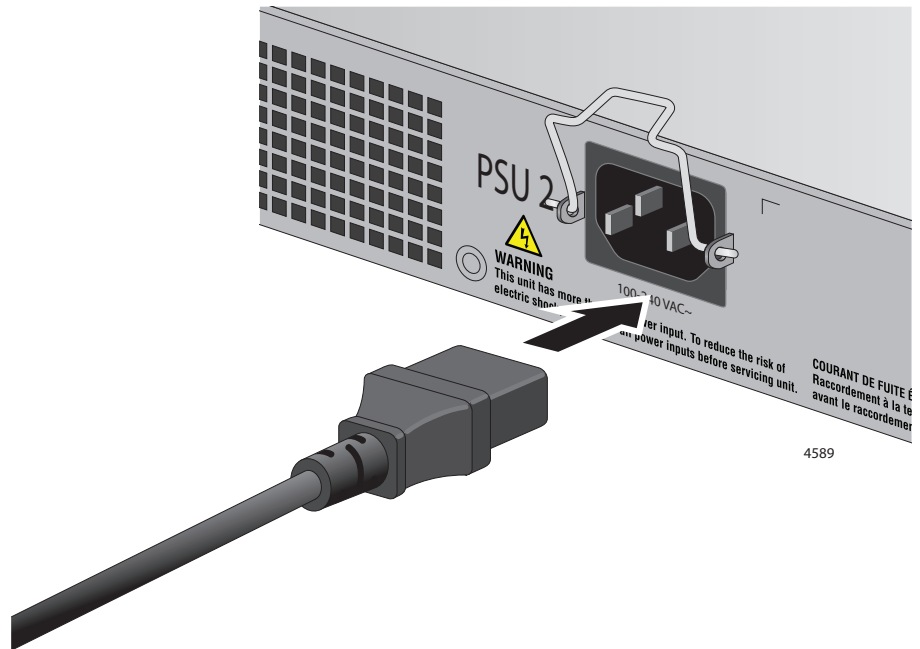

Figure 81. Plugging in the AC Power Cord to the Switch

3. Lower the power cord retaining clip to secure the cord to the switch. Refer to Figure 82.

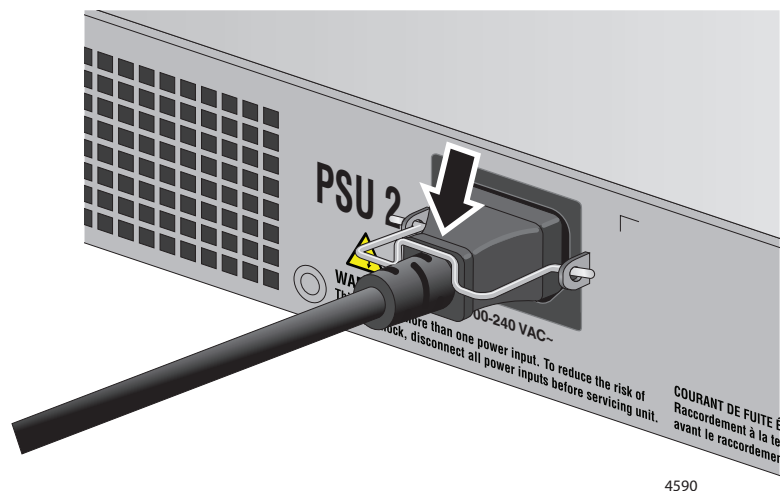

Figure 82. Lowering the Power Cord Retaining Clip

4. Connect the power cord to an appropriate power source. See Figure 83. Refer to “Power Specifications” on page 221 for the power specifications of the switches.

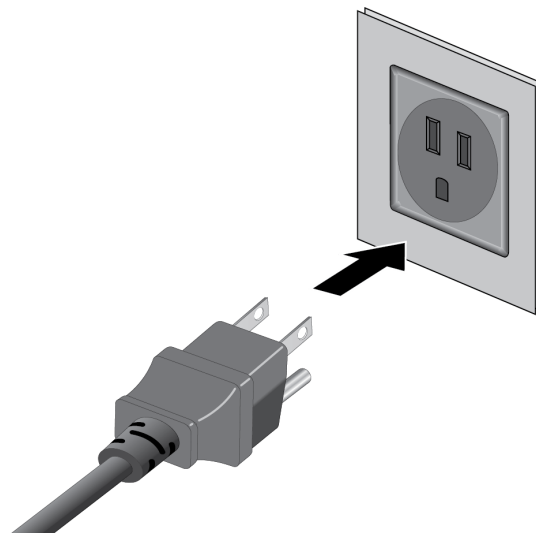

Figure 83. Plugging in the AC Power Cord to an AC Source



---

**Warning**

Power cord is used as a disconnection device. To de-energize equipment, disconnect the power cord. *GE* E3

---

---

**Note**

Pluggable Equipment. The socket outlet shall be installed near the equipment and shall be easily accessible. *GE* E5

---

5. Wait one minute for the switch to initialize its management software.

The switch should be displaying the number 1 on its ID LED.

6. Repeat step 1 through 4 to power on the switch to be assigned ID number 2.
7. Wait two minutes for the new switch to join the stack as a member.

As the new switch boots up, the first switch, which has the ID number 1 and at this point is the master switch of the stack, notifies the new switch that its current ID number is already being used and that it should change its number to the next available number, which is 2. The new switch responds by automatically changing its ID number to 2 and reboots. So the new switch is actually booting up twice, once with the ID number 1 and again with its new ID number 2, which is why it takes two minutes before the device becomes a full member of the stack.

8. If there is a third switch, power it on and wait another two minutes for it to join the stack as a member with the ID number 3.
9. If there are additional switches, continue to power each one at a time and wait two minutes for it to join the stack as a member with the next ID number.

At this point, the stack is operational.

The ID numbers are automatically stored in special files in the flash memories of the switches and are retained by the devices even if you reset or power cycle the stack.

To continue with the installation, go to “Starting a Local Management Session” on page 150 and “Verifying the Stack” on page 153.

## Powering On the Switches Simultaneously

---

If you want the switches of the stack to use their MAC addresses to automatically assign the ID numbers during the initial power on sequence, all you have to do is power them on simultaneously, rather than one at a time as in the previous procedure. Here are the steps the switches perform:

- ❑ They initialize their management software and compare their MAC addresses.
- ❑ The switch with the lowest address is designated as the master switch of the stack.
- ❑ The master switch assigns itself the ID number 1.
- ❑ The master switch assigns ID numbers to the other switches.
- ❑ The other switches reset and initialize their management software again, with their new ID numbers.

This procedure assumes the following:

- ❑ This is the first power on sequence of the stack.
- ❑ You cabled ports on the switches to form the stack trunk:
  - x530L-10GHXm ports 9 and 10
  - x530L-18GHXm ports 17 and 18
  - x530L-28GPX and x530L-28GTX ports 27 and 28
  - x530L-52GPX and x530L-52GTX ports 51 and 52
- ❑ All the switches are powered off.

To monitor the power on sequence, you can connect a terminal or computer with a terminal emulator program to the Console port on any of the switches. The messages are found in “Monitoring the Initialization Processes” on page 158.

Before powering on a switch, refer to “Power Specifications” on page 221 for the power specifications of the switches.

To have the switches automatically assign the ID numbers, perform the following procedure:

1. Power on all the switches in the stack at the same time.

Connect the power cords to the connectors on the back panels and to the appropriate power sources, as shown in Figure 82 on page 145 and Figure 83 on page 146. Refer to “Power Specifications” on page 221 for the power specifications of the switches.





**Warning**

Power cord is used as a disconnection device. To de-energize equipment, disconnect the power cord. *↪* E3

---

**Note**

Pluggable Equipment. The socket outlet shall be installed near the equipment and shall be easily accessible. *↪* E5

---

2. Wait three minutes for the switches to select a master switch and assign the ID numbers.

At this point, the stack is operational. The ID numbers are automatically stored in special files in the flash memories of the switches and are retained by the devices even if you reset or power cycle the stack.

3. To continue with the installation, go to “Starting a Local Management Session” on page 150 and “Verifying the Stack” on page 153.

## Starting a Local Management Session

---

This procedure explains how to start a local management session on a stack. You can establish the session using any switch in the stack. After establishing the session, go to “Verifying the Stack” on page 153. The procedure requires a VT100 terminal or a VT100 terminal emulator.

Performing a local management session on the switch requires a management cable. Allied Telesis offers two cables. One cable comes with the switch. It has an RJ-45 (8P8C) connector that connects to the Console port on the switch and a DB-9 (D-sub 9-pin) connector that connects to your workstation. Refer to Figure 84.

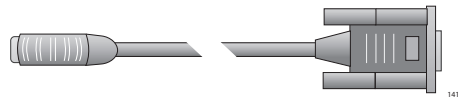

Figure 84. Management Cable Included with Switch

For workstations that do not have a DB-9 connector, such as laptop computers, Allied Telesis offers the optional VT-Kit3 management cable. Refer to Figure 85. The cable has a USB-A male connector that connects to a USB port on your workstation.



Figure 85. VT-Kit3 Management Cable

To use the cable, you connect it to the Console port with a standard, straight-through Ethernet cable. Refer to Figure 87 on page 151. The cable requires a software driver from Allied Telesis. The VT-Kit3 management cable is sold separately.

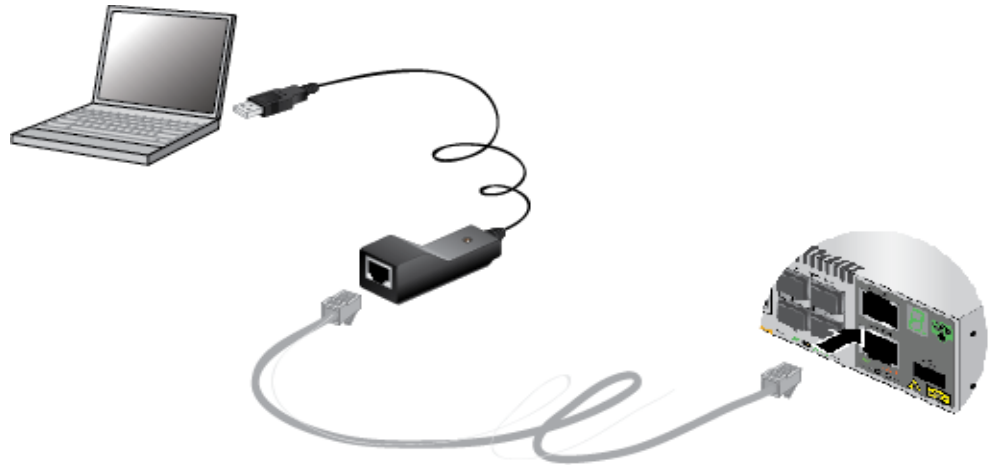
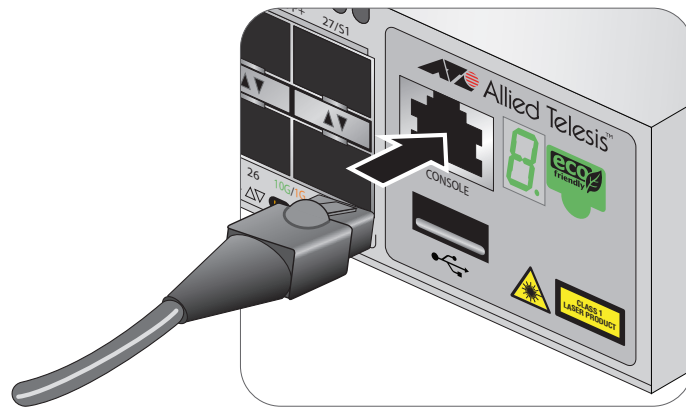

Figure 86. Management Workstation, VT-Kit3 Management Cable, and Switch

To start a local management session on the stack, perform the following procedure:

1. Connect the RJ-45 connector of the management cable to the console port on the front panel of any switch in the stack. Refer to Figure 87.



4578

Figure 87. Connecting the Management Cable to the Console Port

2. Connect the other end of the cable to an RS-232 port on a terminal or computer with a terminal emulator program.

3. Configure the terminal or terminal emulator program as follows:

- Default baud rate: 9,600 bps (range is 9,600 to 115,200 bps)
- Data bits: 8
- Parity: None
- Stop bits: 1
- Flow control: None

---

**Note**

The port settings are for a DEC VT100 or ANSI terminal, or an equivalent terminal emulator program.

---

4. Press Enter.

You are prompted for a user name and password.

5. When prompted, type a user name and password to log on the switch. If this is the initial management session, enter “manager” as the user name and “friend” as the password. The user name and password are case sensitive.

The local management session starts when the User Exec mode prompts:

```
awp1us>
```

---

**Note**

The User Exec mode is the first level in the command mode interface. For complete information on the modes and commands, refer to the *Software Reference for x530 Series Switches, AlliedWare Plus Operating System* at [www.alliedtelesis.com](http://www.alliedtelesis.com).

---

6. Go to “Verifying the Stack” on page 153.

## Verifying the Stack

To verify the stack, perform the following procedure:

1. Start a local management session on any switch in the stack. Refer to “Starting a Local Management Session” on page 150.
2. From the User Exec mode, type the SHOW STACK command:

```
awplus> show stack
```

The following example is from a stack of three switches:

```
awplus> show stack
Virtual Chassis Stacking summary information
ID      Pending ID      MAC address      Priority      Status      Role
1       -                e01a:ea20:8011  128          Ready       Active Master
2       -                e01a:ea20:8012  128          Ready       Member
3       -                e01a:ea20:8902  128          Ready       Member
Operational Status      Normal operations
```

Consider the following:

- The command should list all switches in the stack. If the list is incomplete, refer to Chapter 10, “Troubleshooting” on page 211.
  - The Operational Status field should be “Normal operations” to indicate that all of the stacking ports are operating normally.
  - If the Operational Status field is displaying “Not all stack ports are up,” one or more stacking ports are not being used or cannot establish links with their counterparts. For more information, refer to Chapter 10, “Troubleshooting” on page 211.
  - The priority values will be 128, the default value, if you did not change them.
  - There is no relationship between the ID numbers and the selection of the master switch. Consequently, the active master in the SHOW STACK command might not have the ID number 1.
3. Do one of the following:
    - If you want to add more SFP+ ports to the trunk, perform “Adding Ports 25 and 26 on the x530L-28GPX or x530L-28GTX Switch to the Stack Trunk” on page 154 or “Adding Ports 49 and 50 on the x530L-52GPX or x530L-52GTX Switch to the Stack Trunk” on page 156.
    - If you want to change the priority values of the switches, go to “STACK PRIORITY” on page 164. The procedure is optional.
    - Otherwise, go to Chapter 9, “Cabling the Networking Ports” on page 203, to complete the installation.

## Adding Ports 25 and 26 on the x530L-28GPX or x530L-28GTX Switch to the Stack Trunk

This procedure explains how to add ports 25 and 26 to the stack trunk on the x530L-28GPX or x530L-28GTX switch. The procedure assumes the following:

- ❑ You performed the procedures earlier in this chapter to power on and verify the stack with ports 27 and 28 as the stack trunk.
- ❑ Ports 25 and 26 are not cabled. If there are cables connected to the ports, remove them before performing the procedure.

To add ports 25 and 26 to the stack trunk, perform the following procedure:

Table 20. Adding Ports 25 and 26 to the Stack Trunk on the x530L-28GPX or x530L-28GTX Switch

Step	Description and Command
1	Start a local management session on any switch in the stack. Refer to “Starting a Local Management Session” on page 150.
2	Move to the Privileged Exec mode with the ENABLE command.  awplus> enable
3	Move to the Global Configuration mode with the CONFIGURE TERMINAL command.  awplus# configure terminal Enter configuration commands, one per line. End with CNTL/Z.
4	Enter the port Interface mode for ports 25 and 26 on all the x530L-28GPX or x530L-28GTX switches in the stack. This example assumes the stack has four switches:  awplus(config)# interface port1.0.25-1.0.26,port2.0.25-2.0.26,port3.0.25-3.0.26,port4.0.25-4.0.26
5	Designate the ports as stacking ports with the STACKPORT command.  awplus(config-if)# stackport % Save the config and restart the system for this change to take effect.
6	Return to the Global Configuration mode.  awplus(config-if)# exit
7	Return to the Privileged Exec mode.  awplus(config)# exit

Table 20. Adding Ports 25 and 26 to the Stack Trunk on the x530L-28GPX or x530L-28GTX Switch

Step	Description and Command
8	Enter the WRITE command to save your change.  awplus# write Building configuration ... [OK]
9	Power off the switches of the stack.
10	Cable ports 25 and 26.
11	Power on the switches.
12	Wait three minutes for the switches to initialize their management software and form the stack.
13	Repeat “Verifying the Stack” on page 153.

## Adding Ports 49 and 50 on the x530L-52GPX or x530L-52GTX Switch to the Stack Trunk

This procedure explains how to add ports 49 and 50 to the stack trunk on the x530L-52GPX or x530L-52GTX switches. The procedure assumes the following:

- ❑ You performed the procedures earlier in this chapter to power on and verify the stack with ports 51 and 52 as the stack trunk.
- ❑ Ports 49 and 50 are not cabled. If there are cables connected to the ports, remove them before performing the procedure.

To add ports 49 and 50 to the stack trunk, perform the following procedure:

Table 21. Adding Ports 49 and 50 to the Stack Trunk on the x530L-52GPX or x530L-52GTX Switch

Step	Description and Command
1	Start a local management session on any switch in the stack. Refer to “Starting a Local Management Session” on page 150.
2	Move to the Privileged Exec mode with the ENABLE command.  awplus> enable
3	Move to the Global Configuration mode with the CONFIGURE TERMINAL command.  awplus# configure terminal Enter configuration commands, one per line. End with CNTL/Z.
4	Enter the port Interface mode for ports 49 and 50 on all the switches in the stack. This example assumes the stack has four switches:  awplus(config)# interface port1.0.49-1.0.50,port2.0.49-2.0.50,port3.0.49-3.0.50,port4.0.49-4.0.50
5	Designate the ports as stacking ports with the STACKPORT command.  awplus(config-if)# stackport % Save the config and restart the system for this change to take effect.
6	Return to the Global Configuration mode.  awplus(config-if)# exit
7	Return to the Privileged Exec mode.  awplus(config)# exit



Table 21. Adding Ports 49 and 50 to the Stack Trunk on the x530L-52GPX or x530L-52GTX Switch

Step	Description and Command
8	Enter the WRITE command to save your change.  <pre>awplus# write Building configuration ... [OK]</pre>
9	Power off the switches of the stack.
10	Cable ports 49 and 50.
11	Power on the switches.
12	Wait three minutes for the switches to initialize their management software and form the stack.
13	Repeat "Verifying the Stack" on page 153.

## Monitoring the Initialization Processes

It takes about two minutes for the switch to initialize its management software programs and features, and load the default configuration. You can monitor the bootup sequence by connecting a terminal or computer with a terminal emulator program to the Console port. (The Console port settings are provided in “Starting a Local Management Session” on page 150.) The switch displays the messages in Figure 88 through Figure 90 on the Console port as it initializes the management software.

```

Bootloader 6.2.12 loaded
Press <Ctrl+B> for the Boot Menu
Reading flash:x530L-5.5.0-2-rc1.rel...
Verifying release... OK
Booting...
Starting base/first... [ OK ]
Mounting virtual filesystems... [ OK ]

      _____
     / \         / / _____ \
    /   \       _/ / | _____ |
   /     \     | / | | _____ |
  /       \   \| / | | _____ |
 /         \  \| / | | _____ /
/_____ \ / \ / | | _____ /

Allied Telesis Inc.
Alliedware Plus (TM) v5.5.0
Current release filename: x530L-5.5.0-2-rc1.rel...
Built: Mon Nov 26 01:57:50 UTC 2021
Mounting static filesystems... [ OK ]
Attaching to /dev/mtd0... [ OK ]
Mounting file system... [ OK ]
Checking for last gasp debug output... [ OK ]
Checking NVS filesystem... [ OK ]
Mounting NVS filesystem... [ OK ]
Initializing random number generator... [ OK ]
Starting base/hwrandom... [ OK ]
Starting base/jitterentropy-rngd... [ OK ]
Starting base/dbus... [ OK ]
Starting base/linux... [ OK ]
Starting base/syslog... [ OK ]

```

Figure 88. Switch Initialization Messages

```

Starting base/loopback... [ OK ]
Starting base/poe_done... [ OK ]
Starting base/portmapper... [ OK ]
Received event syslog.done
Starting base/modules... [ OK ]
Received event modules.done
Starting base/reboot-stability... [ OK ]
Checking system reboot stability... [ OK ]
Starting base/apteryx... [ OK ]
Starting base/crond... [ OK ]
Starting base/appmond... [ OK ]
Starting base/clockcheck... [ OK ]
Starting network/execd... [ OK ]
Starting base/inet... [ OK ]
Received event apteryx.done
Starting hardware/early_host_info... [ OK ]
Starting base/alfred... [ OK ]
Starting base/kernond... [ OK ]
Starting base/apteryx-sync... [ OK ]
Starting base/logconf... [ OK ]
Received event apteryx-sync.done
Starting hardware/platformd... [ OK ]
Starting hardware/plugman... [ OK ]
Starting hardware/timeout... [ OK ]
Starting hardware/hardware-done... [ OK ]
Received event board.inserted
Received event hardware.done
Starting base/external-media... [ OK ]
Starting network/startup... [ OK ]
Starting network/hostcfg... [ OK ]
Received event hostcfg.done
Starting network/cmplplatformd... [ OK ]
Starting base/eventwatch... [ OK ]
Starting network/startup... [ OK ]
Starting hardware platform_eventd... [ OK ]
Starting network/licd... [ OK ]
Starting network/stackd... [ OK ]
Starting network/election.timeout... [ OK ]
Starting network/corosync... [ OK ]
Received event network.enabled

```

Figure 89. Switch Initialization Messages (Continued)

Initializing HA processes:

```
atmf_agentd, execd, exfx, hostd, atmfd, auth, epsr  
hsl, imi, imiproxyd, lldpd, loopprot, mstp, nsm  
pim6d, ripngd, rmon, sflowd, vrrpd, bgpd, irdpd  
lacp, ospf6d, ospfd, pdmd, pimd, ripd, udldd
```

Received event network.initialized

Assigning Active workload to HA processes:

```
hsl, irdpd, lacpd, loopprotd, mstpd, nsm, ospfd  
ripd, rmond, sflowd, vrrpd, authd, epsrd, imi  
imiproxyd, lldpd
```

Received event network.activated

Loading default configuration

..

done!

Received event network.configured

Figure 90. Switch Initialization Messages (Continued)

## Chapter 8

# Building the Stack Trunk with 5Gbps Multi-Speed Ports

---

This chapter applies to the x530L-10GHXm and x530L-18GHXm switches only, since the x530L-28GPX, x530L-28GTX, x530L-52GPX, and x530L-52GTX switches do not have 5Gbps ports, and contains the following sections:

- ❑ “Introduction” on page 162
- ❑ “Command Summary” on page 163
- ❑ “Configuring the Master x530L-10GHXm Switch” on page 166
- ❑ “Configuring the Master x530L-18GHXm Switch” on page 175
- ❑ “What to Do Next” on page 184
- ❑ “Configuring the x530L-10GHXm Member Switches” on page 185
- ❑ “Configuring the x530L-18GHXm Member Switches” on page 192
- ❑ “What to Do Next” on page 199
- ❑ “Powering on the Stack” on page 200
- ❑ “Verifying the Stack” on page 201

## Introduction

---

The trunk ports of a stack of x530L-10GHXm or x530L-18GHXm switches can be multi-speed 5Gbps ports or the SFP+ 10Gbps ports. The default trunk ports are 10Gbps ports. Directions on how to use the default ports as the stack trunk are provided in Chapter 7, “Building the Trunk with the Default 10Gbps Stacking Ports” on page 141.

This chapter contains the procedures for configuring x530L-10GHXm or x530L-18GHXm switches to use 5 Gbps ports for the stack trunk.

Here are the general steps:

1. Fill in “Stacking Worksheet” on page 85.
2. Review the configuration commands in “Command Summary” on page 163.
3. Perform “Configuring the Master x530L-10GHXm Switch” on page 166 or “Configuring the Master x530L-18GHXm Switch” on page 175.
4. Perform “Configuring the x530L-10GHXm Member Switches” on page 185 or “Configuring the x530L-18GHXm Member Switches” on page 192.
5. Perform “Powering on the Stack” on page 200.
6. Perform “Verifying the Stack” on page 201.

Review the following information before performing the instructions:

- Perform the procedures in the order presented here.
- Choose the master switch before beginning the procedure. It can be any of the switches. Refer to “Master and Member Switches” on page 76.
- If you have not selected the trunk ports yet, you should do so before continuing. Refer to “Stack Trunks of 5Gbps Ports on the x530L-10GHXm or x530L-18GHXm Switch” on page 71.
- If you have already connected network cables to the ports of the stack trunk, disconnect them before continuing. You should cable the ports after configuring the switches for stacking.

---

### Note

Cabling the ports of the stack trunk before configuring the switches can result in loops in your network topology, which can cause poor network performance.

---

## Command Summary

---

The following sections briefly describe the commands for configuring the master and member switches for stacking with the 5Gbps ports. For further instructions, refer to the *Command Reference: x530 Series Switches Running AlliedWare Plus Version 5.5.0* at [www.alliedtelesis.com/library](http://www.alliedtelesis.com/library). After reviewing the commands, go to “Configuring the Master x530L-10GHXm Switch” on page 166 or “Configuring the Master x530L-18GHXm Switch” on page 175 to start the configuration procedures.

### STACKPORT

This command designates the ports of the stack trunk. After you enter the command, the designated ports stop functioning as regular Ethernet ports and function instead as the stack trunk.

For example, If you are using the SFP+ ports of x530L-10GHXm or x530L-18GHXm switch as the stack trunk, you do not have to perform this command because those ports are the default trunk ports. However, if you want to use the 5Gbps ports as trunk ports, you have to designate them with this command. Refer to Table 17 on page 61 for a list of the default and optional trunk ports.

The command is performed in the Interface mode of the selected ports.

x530L-10GHXm – In this example, the optional stacking ports 7 to 8 are designated as the stack trunk:

```
awplus(config)# interface port1.0.7-1.0.8
awplus(config-if)# stackport
```

x530L-18GHXm – In this example, the optional stacking ports 15 to 16 are designated as the stack trunk:

```
awplus(config)# interface port1.0.15-1.0.16
awplus(config-if)# stackport
```

To remove the stacking function from ports and return them to regular Ethernet networking ports, use the NO STACKPORT command. You might perform this command if you are not using the SFP+ ports as the stack trunk and want to use them instead as regular Ethernet ports, or if you inadvertently assign the stacking function to the wrong ports.

x530L-10GHXm – This example removes the stacking function from the default stacking ports 9 and 10:

```
awplus(config)# interface port1.0.9-1.0.10
awplus(config-if)# no stackport
```

x530L-18GHXm – This example removes the stacking function from the default stacking ports 17 and 18:

```
awplus(config)# interface port1.0.17-1.0.18
awplus(config-if)# no stackport
```

## STACK ENABLE

This command enables the VCStack feature on the switch. You will probably not have to perform this command because the default setting for the feature is enabled. However, if for any reason the feature was disabled, you can enable it by entering the STACK ENABLE command in the Global Configuration mode. Here is the command:

```
awplus(config)# stack enable
```

If you ever want to disable stacking, such as to use the switch as a stand-alone unit, enter the NO STACK ENABLE command, shown here:

```
awplus(config)# no stack enable
```

## STACK PRIORITY

This command assigns priority numbers to the switches of the stack. The switches use the numbers to select the master switch. The lower the number the higher the priority. The unit with the lowest number becomes the master. If both switches have the same priority value, their MAC address is used to determine the master. As with priority numbers, the lower the MAC address, the higher the priority. A switch can have only one priority number.

Allied Telesis recommends changing a switch's priority number to match its ID number. For example, the switch with ID 1 should be assigned priority 1, switch with ID 2 should be assigned priority 2, and so on. This is not required, but it can make managing and troubleshooting the stack easier.

The STACK PRIORITY command is found in the Global Configuration mode and has the following format:

```
stack <switch_ID> priority <priority_number>
```

The variables are defined here:

- ❑ `switch_ID` – This is the ID number of the switch. The range is 1 to 8. You can specify only one ID number.
- ❑ `priority_number` – This is the new priority number for the switch. You can specify only one number. The range is 0 to 255. The default is 128.



This example assigns the priority 1 to the switch with ID 1:

```
awplus(config)# stack 1 priority 1
```

## STACK RENUMBER

Every switch in a stack must have a unique ID number. The range is 1 to 8. The default is 1. The master switch should use the default value. The number is set on the member switches with the STACK RENUMBER command. Here is the format:

```
stack <current_switch_ID> renumber <new_switch_ID>
```

The variables are defined here:

- ❑ `current_switch_ID` – This is the current ID number of the switch. You can specify only one ID number.
- ❑ `new_switch_ID` – This is the new ID number for the switch. You can specify only one number. The range is 1 to 8. The default is 1.

Changing the ID number requires resetting the switch.

This example changes a switch ID from 1, the default, to 2:

```
awplus(config)# stack 1 renumber 2
```

## SWITCH PROVISION

To ensure that the first power-on of the stack is successful, configure the master switch such that it is aware of the member switches, prior to forming the stack. This involves using the SWITCH PROVISION command to add the member switches as provisioned units on the master switch. Here is the format of the command:

To add a provisioned member switch, use this format:

```
switch <switch_ID> provision <switch_name>
```

The following examples add a provisioned member switch with the ID 2 to the master switch

x530L-10GHXm

```
awplus(config)# switch 2 provision x530L-10
```

x530L-18GHXm

```
awplus(config)# switch 2 provision x530L-18
```

## Configuring the Master x530L-10GHXm Switch

---

This section contains the following procedures for configuring the master x530L-10GHXm switch of the stack:

- ❑ “General Steps for the Master x530L-10GHXm Switch,” next
- ❑ “Configuring the Master x530L-10GHXm Switch – Part I” on page 167
- ❑ “Configuring the Master x530L-10GHXm Switch – Part II” on page 170
- ❑ “Verifying the x530L-10GHXm Master Switch” on page 172
- ❑ “What to Do Next” on page 184

---

### Note

The procedures require resetting the switch. Some network traffic will be lost if the unit is already connected to an active network.

---

You need to know the following to perform these procedures:

- ❑ How many member switches will be in the stack?
- ❑ Which 5Gbps ports will be used as the stack trunk on the master and member switches? Refer to “Stack Trunks” on page 61.

The procedures should be performed in the order presented here.

### General Steps for the Master x530L-10GHXm Switch

The procedure for configuring the master switch to use 5Gbps as the stacking ports is divided into two parts. Here are the general steps to Part I:

1. Start a local management session on the switch.
2. Display the hardware status and management software version number with the `SHOW SYSTEM ENVIRONMENT` and `SHOW VERSION INSTALLED` commands, respectively, in the Privilege Exec mode.
3. Enable the VCStack feature with the `STACK ENABLE` command in the Global Configuration mode. You will probably not have to perform this step because the default setting for the feature is enabled.
4. Assign the master switch the priority 1 with the `STACK PRIORITY` command in the Global Configuration mode. This is to ensure that it is selected as the master switch during the first power-on of the stack.
5. Remove the stacking function from the default stacking ports 9 and 10 on the master switch with the `NO STACKPORT` command.

6. Designate the 5Gbps ports as the stack trunk on the master switch, with the STACKPORT command.
7. Save your changes with the WRITE command in the Privileged Exec mode.

Here are the general steps to Part II:

1. Add the member switches as provisioned units to the master switch, with the SWITCH PROVISION command. This step is to ensure that the master switch knows about the member switch during the first power-on of the stack.
2. Remove the stacking function from the default stacking ports 9 and 10 on the provisioned member switches with the NO STACKPORT command.
3. Designate the 5Gbps ports as the stack trunk on the provisioned member switches, with the STACKPORT command.
4. Save your changes with the WRITE command in the Privilege Exec mode.
5. Reboot the switch with the REBOOT command.
6. Start a new local management session.
7. Verify the changes with the SHOW STACK and SHOW RUNNING-CONFIG command.

### **Configuring the Master x530L- 10GHXm Switch – Part I**

To configure the master x530L-10GHXm switch to use 5Gbps ports for the stack trunk, perform the procedure in Table 22.

Table 22. Configuring the Master x530L-10GHXm Switch for 5Gbps Stacking Ports – Part I

<b>Step</b>	<b>Description and Command</b>
1	Power on the master switch and wait two minutes for it to initialize the management software. Refer to Chapter 8, “Powering on the Stack” on page 200.
2	Start a local management session. Refer to “Starting a Local Management Session” on page 150.
3	Move to the Privileged Exec mode with the ENABLE command.  awplus> enable

Table 22. Configuring the Master x530L-10GHXm Switch for 5Gbps Stacking Ports – Part I

Step	Description and Command
<p>Steps 4 to 6 display the status of the switch hardware and the version number of the AlliedWare Plus management software.</p>	
<p>4</p>	<p>Verify that the switch hardware is operating correctly by entering the SHOW SYSTEM ENVIRONMENT command. All components should have the status Ok.</p> <pre>awplus# show system environment Environment Monitoring Status Overall Status: Normal Resource ID: 1 Name: x530L-10 ID  Sensor (Units)          Reading    Low Limit  High Limit  Status 1   Fan: Fan 1 (RPM)        5980      4800      -           ok 2   voltage: 1.0V (Volts)   1.040     0.891     1.090      ok .</pre>
<p>5</p>	<p>Display the version number of the AlliedWare Plus operating software on the switch by entering the SHOW VERSION INSTALLED command. Write down the version number in the worksheet in Table 18 on page 85. After viewing the version numbers on all of the switches, you will compare them to confirm they all have the same version. Switches with different versions will have to be updated.</p> <pre>awplus# show version installed Current software ----- Software version   :  value Build date        :  value  Installed software ----- Build name         :  value Build version     :  value Build date        :  value</pre>
<p>6</p>	<p>Move to the Global Configuration mode with the CONFIGURE TERMINAL command.</p> <pre>awplus# configure terminal Enter configuration commands, one per line. End with CNTL/Z.</pre>

Table 22. Configuring the Master x530L-10GHXm Switch for 5Gbps Stacking Ports – Part I

Step	Description and Command
	Step 7 enables the VCStack feature on the switch. You probably do not need to perform this step because the feature is enabled by default. If the Switch ID LED is displaying “0”, perform the step. Otherwise, go to step 8.
7	<p>Activate VCStack on the switch with the STACK ENABLE command.</p> <pre>awplus(config)# stack enable % Automatically enabling 'stack virtual-mac' to minimize disruption from failovers. % Please check that the new MAC 0000.cd37.0431 is unique within the network. % Save the config and restart the system for this change to take effect.</pre>
	Step 8 assigns priority 1 to the switch with the STACK PRIORITY command, so that it functions as the master unit of the stack.
8	<p>Assign priority 1 to the switch with the STACK PRIORITY.</p> <pre>awplus(config)# stack 1 priority 1</pre>
	Steps 9 to 10 remove stacking from the default stacking ports 9 and 10 so that they function as regular networking ports.
9	<p>Enter the Interface modes for the default stacking ports 9 and 10 on the master switch:</p> <pre>awplus(config)# interface port1.0.9-1.0.10 % port1.0.9 is currently configured as a stack-port. Use caution when altering its config. % port1.0.10 is currently configured as a stack-port. Use caution when altering its config.</pre>
10	<p>Remove the stacking function from the ports with the NO STACKPORT command, so that they function as regular networking ports:</p> <pre>awplus(config-if)# no stackport % Save the config and restart the system for this change to take effect.</pre>
	Steps 11 and 12 designate 5Gbps ports as the active stacking ports.
11	<p>Enter the Interface mode of the 5Gbps ports to be used as the stack trunk. If you filled out the worksheet in “Stacking Worksheet” on page 85, refer there for the ports. This example assumes you want to use 5Gbps ports 7 and 8 as the stack trunk.</p> <pre>awplus(config-if)# interface port1.0.7-1.0.8</pre>
12	<p>Designate the ports as the stack trunk with the STACKPORT command:</p> <pre>awplus(config-if)# stackport % Save the config and restart the system for this change to take effect.</pre>

Table 22. Configuring the Master x530L-10GHXm Switch for 5Gbps Stacking Ports – Part I

Step	Description and Command
The remaining steps save your changes.	
13	Return to the Global Configuration mode with the EXIT command:  awplus(config-if)# exit
14	Return to the Privileged Exec mode.  awplus(config)# exit
15	Enter the WRITE command to save your change. If this is the first management session, the switch adds the configuration file DEFAULT.CFG to flash memory, for storing your configuration changes. If you do not save your changes, they will be discarded and you will have to re-enter them when you reboot the switch later in these procedures.  awplus# write Building configuration ... [OK]
16	Go to “Configuring the Master x530L-10GHXm Switch – Part II,” next.

### Configuring the Master x530L- 10GHXm Switch – Part II

In Part II, you add the member switches as provisioned units to the master switch and designate their 5Gbps trunk ports. Adding member switches as provisioned devices ensures that the master switch is aware of them during the first stack power-on. The procedure assumes you are continuing directly from the previous procedure.

Table 23. Configuring the Master x530L-10GHXm Switch for 5Gbps Stacking Ports – Part II

Step	Description and Command
Steps 1 to 2 add the member switches as provisioned switches on the master switch. This is so the master switch is aware of the switches when the stack is powered on for the first time.	
1	Move to the Global Configuration mode with the CONFIGURE TERMINAL command.  awplus# configure terminal Enter configuration commands, one per line. End with CNTL/Z.
2	Add the member switches to the master switch as provisioned switches with the SWITCH PROVISION command. Assign a unique ID number, in the range of 2 to 8, to each unit. The following examples add three provisioned member switches to the master switch, with the IDs 2 to 4:  awplus(config)# switch 2 provision x530L-10 awplus(config)# switch 3 provision x530L-10 awplus(config)# switch 4 provision x530L-10

Table 23. Configuring the Master x530L-10GHXm Switch for 5Gbps Stacking Ports – Part II

Step	Description and Command
Steps 3 and 4 remove the stacking function from the default stacking ports 9 and 10 on the provisioned member switches.	
3	<p>Enter the port Interface modes of the default stacking ports 9 and 10 on the provisioned member switches. The example here assumes there are three provisioned member switches, with the IDs 2 to 4:</p> <pre>awplus(config)# interface port2.0.9-2.0.10,port3.0.9-3.0.10,port4.0.9-4.0.10</pre>
4	<p>Remove the stacking function from the ports to convert them into regular Ethernet ports, with the NO STACKPORT command:</p> <pre>awplus(config-if)# no stackport % Save the config and restart the system for this change to take effect.</pre>
Steps 5 and 6 add the stacking function to the selected 5Gbps trunk ports on the provisioned member switches.	
5	<p>Enter the Interface modes of the 5Gbps ports to be used as the stack trunk on the provisioned member switches. If you filled out the worksheet on Table 18 on page 85, refer there for the stacking ports. This example assumes that there are three member switches that are to use ports 7 and 8 as the stack trunk.</p> <pre>awplus(config)# interface port2.0.7-2.0.8,port3.0.7-3.0.8,port4.0.7-4.0.8</pre>
6	<p>Designate the ports as stacking ports with the STACKPORT command.</p> <pre>awplus(config-if)# stackport % Save the config and restart the system for this change to take effect.</pre>
Steps 7 to 13 save your changes on the master switch and reboot it.	
7	<p>Return to the Global Configuration mode.</p> <pre>awplus(config-if)# exit</pre>
8	<p>Return to the Privileged Exec mode.</p> <pre>awplus(config)# exit</pre>
9	<p>Enter the WRITE command to save your changes.</p> <pre>awplus# write Building configuration ... [OK]</pre>

Table 23. Configuring the Master x530L-10GHXm Switch for 5Gbps Stacking Ports – Part II

Step	Description and Command
10	Restart the switch with the REBOOT command.  awplus# reboot reboot system? (y/n): awplus#
11	Type “Y” for yes.
12	Wait two minutes for the switch to initialize the management software.
13	Go to “Verifying the x530L-10GHXm Master Switch” on page 172.

**Verifying the  
x530L-10GHXm  
Master Switch**

Perform the steps in Table 24 to confirm the configuration of the master switch.

Table 24. Verifying the Master x530L-10GHXm Switch

Step	Description and Command
1	Start a new local management session on the master switch.
2	Move to the Privileged Exec mode with the ENABLE command.  awplus> enable



Table 24. Verifying the Master x530L-10GHXm Switch (Continued)

Step	Description and Command
3	<p>Enter the SHOW STACK command. Here is an example of the display:</p> <pre>awplus# show stack Virtual Chassis Stacking summary information ID Pending ID  MAC address          Priority  Status  Role 1  -             e01a.ba56.c208      1        Ready   Active Master 2  -             -                   -         -       Provisioned 3  -             -                   -         -       Provisioned 4  -             -                   -         -       Provisioned  Operational status  standalone unit Stack MAC address   e01a.ba56.c208</pre> <p>Check the display for the following:</p> <ul style="list-style-type: none"> <li>- Switch ID 1 is the master switch.</li> <li>- The master switch should have the priority 1. If it does not, repeat “Configuring the Master x530L-10GHXm Switch – Part I” on page 167. Be sure to perform the STACK PRIORITY command and to save your changes with the WRITE command.</li> <li>- The other ID entries are for the provisioned member switches. There should be one entry for each member switch that will be in the stack. Their fields are empty because the master switch is not yet part of a stack. If the table does not include these fields, repeat “Configuring the Master x530L-10GHXm Switch – Part II” on page 170. Be sure to perform the SWITCH PROVISION command and to save your changes with the WRITE command.</li> <li>- The Operational Status should be Standalone Unit, indicating that stacking is enabled, but that the unit is operating as a stack of one switch. If the status is Stacking Hardware Disabled, the stacking feature is disabled. Repeat “Configuring the Master x530L-10GHXm Switch – Part I” on page 167. Be sure to perform the STACK ENABLE command and to save your changes with the WRITE command.</li> </ul>

Table 24. Verifying the Master x530L-10GHXm Switch (Continued)

Step	Description and Command
4	<p>Enter the SHOW RUNNING-CONFIG command to display the running configuration of the master switch. You should use the display to confirm that you designated the correct 5Gbps trunk ports for the master and member switches. The display should contain INTERFACE PORT commands that identify the ports and are followed by STACKPORT commands. In the following example, ports 7 and 8 on the master and provisioned member switches are to be the stack trunk:</p> <pre> interface port1.0.7-1.0.8 stackport . interface port2.0.7-2.0.8 stackport . interface port3.0.7-3.0.8 stackport . interface port4.0.7-4.0.8 stackport </pre>
5	Go to “Configuring the x530L-10GHXm Member Switches” on page 185.

## Configuring the Master x530L-18GHXm Switch

---

This section contains the following procedures for configuring the master x530L-18GHXm switch of the stack:

- ❑ “General Steps for the Master x530L-18GHXm Switch,” next
- ❑ “Configuring the Master x530L-18GHXm Switch – Part I” on page 176
- ❑ “Configuring the Master x530L-18GHXm Switch – Part II” on page 179
- ❑ “Verifying the Master x530L-18GHXm Switch” on page 181
- ❑ “What to Do Next” on page 184

---

### Note

The procedures require resetting the switch. Some network traffic will be lost if the unit is already connected to an active network.

---

You need to know the following to perform these procedures:

- ❑ How many member switches will be in the stack?
- ❑ Which 5Gbps ports will be used as the stack trunk on the master and member switches? Refer to “Stack Trunks” on page 61.

The procedures should be performed in the order presented here.

### General Steps for the Master x530L-18GHXm Switch

The procedure for configuring the master switch to use 5Gbps as the stacking ports is divided into two parts. Here are the general steps to Part I:

1. Start a local management session on the switch.
2. Display the hardware status and management software version number with the `SHOW SYSTEM ENVIRONMENT` and `SHOW VERSION INSTALLED` commands, respectively, in the Privilege Exec mode.
3. Enable the VCStack feature with the `STACK ENABLE` command in the Global Configuration mode. You will probably not have to perform this step because the default setting for the feature is enabled.
4. Assign the master switch the priority 1 with the `STACK PRIORITY` command in the Global Configuration mode. This is to ensure that it is selected as the master switch during the first power-on of the stack.
5. Remove the stacking function from the default stacking ports 17 and 18 on the master switch with the `NO STACKPORT` command.

6. Designate the 5Gbps ports as the stack trunk on the master switch, with the STACKPORT command.
7. Save your changes with the WRITE command in the Privileged Exec mode.

Here are the general steps to Part II:

1. Add the member switches as provisioned units to the master switch, with the SWITCH PROVISION command. This step is to ensure that the master switch knows about the member switch during the first power-on of the stack.
2. Remove the stacking function from the default stacking ports 17 and 18 on the provisioned member switches with the NO STACKPORT command.
3. Designate the 5Gbps ports as the stack trunk on the provisioned member switches, with the STACKPORT command.
4. Save your changes with the WRITE command in the Privilege Exec mode.
5. Reboot the switch with the REBOOT command.
6. Start a new local management session.
7. Verify the changes with the SHOW STACK and SHOW RUNNING-CONFIG command.

### Configuring the Master x530L-18GHXm Switch – Part I

To configure the master x530L-18GHXm switch to use 5Gbps ports for the stack trunk, perform the procedure in Table 25.

Table 25. Configuring the Master x530L-18GHXm Switch for 5Gbps Stacking Ports – Part I

Step	Description and Command
1	Power on the master switch and wait two minutes for it to initialize the management software. Refer to Chapter 8, “Powering on the Stack” on page 200.
2	Start a local management session. Refer to “Starting a Local Management Session” on page 150.
3	Move to the Privileged Exec mode with the ENABLE command.  awplus> enable

Table 25. Configuring the Master x530L-18GHXm Switch for 5Gbps Stacking Ports – Part I

Step	Description and Command
	Steps 4 to 6 display the status of the switch hardware and the version number of the AlliedWare Plus management software.
4	<p>Verify that the switch hardware is operating correctly by entering the SHOW SYSTEM ENVIRONMENT command. All components should have the status Ok.</p> <pre>awplus# show system environment Environment Monitoring Status Overall Status: Normal Resource ID: 1 Name: x530L-18 ID Sensor (Units)      Reading    Low Limit  High Limit  Status 1 Fan: Fan 1 (RPM)      5980      4800      -           ok 2 Voltage: 1.0V (Volts) 1.040     0.891     1.090      ok .</pre>
5	<p>Display the version number of the AlliedWare Plus operating software on the switch by entering the SHOW VERSION INSTALLED command. Write down the version number in the worksheet in Table 18 on page 85. After viewing the version numbers on all the switches, you will compare them to confirm they all have the same version. Switches with different versions will have to be updated.</p> <pre>awplus# show version installed Current software ----- Software version   :  value Build date        :  value  Installed software ----- Build name         :  value Build version     :  value Build date        :  value</pre>
6	<p>Move to the Global Configuration mode with the CONFIGURE TERMINAL command.</p> <pre>awplus# configure terminal Enter configuration commands, one per line. End with CNTL/Z.</pre>

Table 25. Configuring the Master x530L-18GHXm Switch for 5Gbps Stacking Ports – Part I

Step	Description and Command
	Step 7 enables the VCStack feature on the switch. You probably do not need to perform this step because the feature is enabled by default. If the Switch ID LED is displaying “0”, perform the step. Otherwise, go to step 8.
7	<p>Activate VCStack on the switch with the STACK ENABLE command.</p> <pre>awplus(config)# stack enable % Automatically enabling 'stack virtual-mac' to minimize disruption from failovers. % Please check that the new MAC 0000.cd37.0431 is unique within the network. % Save the config and restart the system for this change to take effect.</pre>
	Step 8 assigns priority 1 to the switch with the STACK PRIORITY command, so that it functions as the master unit of the stack.
8	<p>Assign priority 1 to the switch with the STACK PRIORITY.</p> <pre>awplus(config)# stack 1 priority 1</pre>
	Steps 9 to 10 remove stacking from the default stacking ports 17 and 18 so that they function as regular networking ports.
9	<p>Enter the Interface modes for the default stacking ports 17 and 18 on the master switch:</p> <pre>awplus(config)# interface port1.0.17-1.0.18 %port1.0.17 is currently configured as a stack-port. Use caution when altering its config. %port1.0.18 is currently configured as a stack-port. Use caution when altering its config.</pre>
10	<p>Remove the stacking function from the ports with the NO STACKPORT command, so that they function as regular networking ports:</p> <pre>awplus(config-if)# no stackport % Save the config and restart the system for this change to take effect.</pre>
	Steps 11 and 12 designate 5Gbps ports as the active stacking ports.
11	<p>Enter the Interface mode of the 5Gbps ports to be used as the stack trunk. If you filled out the worksheet in “Stacking Worksheet” on page 85, refer there for the ports. This example assumes you want to use 5Gbps ports 15 and 16 as the stack trunk.</p> <pre>awplus(config-if)# interface port1.0.15-1.0.16</pre>
12	<p>Designate the ports as the stack trunk with the STACKPORT command:</p> <pre>awplus(config-if)# stackport % Save the config and restart the system for this change to take effect.</pre>

Table 25. Configuring the Master x530L-18GHXm Switch for 5Gbps Stacking Ports – Part I

Step	Description and Command
The remaining steps save your changes.	
13	Return to the Global Configuration mode with the EXIT command:  awplus(config-if)# exit
14	Return to the Privileged Exec mode.  awplus(config)# exit
15	Enter the WRITE command to save your change. If this is the first management session, the switch adds the configuration file DEFAULT.CFG to flash memory, for storing your configuration changes. If you do not save your changes, they will be discarded and you will have to re-enter them when you reboot the switch later in these procedures.  awplus# write Building configuration ... [OK]
16	Go to “Configuring the Master x530L-18GHXm Switch – Part II,” next.

### Configuring the Master x530L- 18GHXm Switch – Part II

In Part II, you add the member switches as provisioned units to the master x530L-18GHXm switch and designate their 5Gbps trunk ports. Adding member switches as provisioned devices ensures that the master switch is aware of them during the first stack power-on. The procedure assumes you are continuing directly from the previous procedure.

Table 26. Configuring the Master x530L-18GHXm Switch for 5Gbps Stacking Ports – Part II

Step	Description and Command
Steps 1 to 2 add the member switches as provisioned switches on the master switch. This is so the master switch is aware of the switches when the stack is powered on for the first time.	
1	Move to the Global Configuration mode with the CONFIGURE TERMINAL command.  awplus# configure terminal Enter configuration commands, one per line. End with CNTL/Z.
2	Add the member switches to the master switch as provisioned switches with the SWITCH PROVISION command. Assign a unique ID number, in the range of 2 to 8, to each unit. The following examples add three provisioned member switches to the master switch, with the IDs 2 to 4:  awplus(config)# switch 2 provision x530L-18 awplus(config)# switch 3 provision x530L-18 awplus(config)# switch 4 provision x530L-18

Table 26. Configuring the Master x530L-18GHXm Switch for 5Gbps Stacking Ports – Part II

Step	Description and Command
Steps 3 and 4 remove the stacking function from the default stacking ports 17 and 18 on the provisioned member switches.	
3	<p>Enter the port Interface modes of the default stacking ports 17 and 18 on the provisioned member switches. The example here assumes there are three provisioned member switches, with the IDs 2 to 4:</p> <pre>awplus(config)# interface port2.0.17-2.0.18,port3.0.17-3.0.18,port4.0.17-4.0.18</pre>
4	<p>Remove the stacking function from the ports to convert them into regular Ethernet ports, with the NO STACKPORT command:</p> <pre>awplus(config-if)# no stackport</pre> <p>% Save the config and restart the system for this change to take effect.</p>
Steps 5 and 6 add the stacking function to the selected 5Gbps trunk ports on the provisioned member switches.	
5	<p>Enter the Interface modes of the 5Gbps ports to be used as the stack trunk on the provisioned member switches. If you filled out the worksheet on Table 18 on page 85, refer there for the stacking ports. This example assumes that there are three member switches that are to use ports 15 and 16 as the stack trunk.</p> <pre>awplus(config)# interface port2.0.15-2.0.16,port3.0.15-3.0.16,port4.0.15-4.0.16</pre>
6	<p>Designate the ports as stacking ports with the STACKPORT command.</p> <pre>awplus(config-if)# stackport</pre> <p>% Save the config and restart the system for this change to take effect.</p>
Steps 7 to 13 save your changes on the master switch and reboot it.	
7	<p>Return to the Global Configuration mode.</p> <pre>awplus(config-if)# exit</pre>
8	<p>Return to the Privileged Exec mode.</p> <pre>awplus(config)# exit</pre>
9	<p>Enter the WRITE command to save your changes.</p> <pre>awplus# write Building configuration ... [OK]</pre>



Table 26. Configuring the Master x530L-18GHXm Switch for 5Gbps Stacking Ports – Part II

Step	Description and Command
10	Restart the switch with the REBOOT command.  awplus# reboot reboot system? (y/n): awplus#
11	Type “Y” for yes.
12	Wait two minutes for the switch to initialize the management software.
13	Go to “Verifying the Master x530L-18GHXm Switch” on page 181.

**Verifying the Master x530L-18GHXm Switch** Perform the steps in Table 24 to confirm the configuration of the master switch.

Table 27. Verifying the Master x530L-18GHXm Switch

Step	Description and Command
1	Start a new local management session on the master switch.
2	Move to the Privileged Exec mode with the ENABLE command.  awplus> enable

Table 27. Verifying the Master x530L-18GHXm Switch (Continued)

Step	Description and Command
3	<p>Enter the SHOW STACK command. Here is an example of the display:</p> <pre>awplus# show stack Virtual Chassis Stacking summary information ID Pending ID  MAC address      Priority  Status  Role 1  -            e01a.ba56.c208    1        Ready   Active Master 2  -            -                 -        -       Provisioned 3  -            -                 -        -       Provisioned 4  -            -                 -        -       Provisioned  Operational status standalone unit Stack MAC address e01a.ba56.c208</pre> <p>Check the display for the following:</p> <ul style="list-style-type: none"> <li>- Switch ID 1 is the master switch.</li> <li>- The master switch should have the priority 1. If it does not, repeat “Configuring the Master x530L-18GHXm Switch – Part I” on page 176. Be sure to perform the STACK PRIORITY command and to save your changes with the WRITE command.</li> <li>- The other ID entries are for the provisioned member switches. There should be one entry for each member switch that will be in the stack. Their fields are empty because the master switch is not yet part of a stack. If the table does not include these fields, repeat “Configuring the Master x530L-18GHXm Switch – Part II” on page 179. Be sure to perform the SWITCH PROVISION command and to save your changes with the WRITE command.</li> <li>- The Operational Status should be Standalone Unit, indicating that stacking is enabled, but that the unit is operating as a stack of one switch. If the status is Stacking Hardware Disabled, the stacking feature is disabled. Repeat “Configuring the Master x530L-18GHXm Switch – Part I” on page 176. Be sure to perform the STACK ENABLE command and to save your changes with the WRITE command.</li> </ul>

Table 27. Verifying the Master x530L-18GHXm Switch (Continued)

Step	Description and Command
4	<p>Enter the SHOW RUNNING-CONFIG command to display the running configuration of the master switch. You should use the display to confirm that you designated the correct 5Gbps trunk ports for the master and member switches. The display should contain INTERFACE PORT commands that identify the ports and are followed by STACKPORT commands. In the following example, ports 15 and 16 on the master and provisioned member switches are to be the stack trunk:</p> <pre> interface port1.0.15-1.0.16   stackport . interface port2.0.15-2.0.16   stackport . interface port3.0.15-3.0.16   stackport . interface port4.0.15-4.0.16   stackport </pre>
5	Go to “Configuring the x530L-18GHXm Member Switches” on page 192.

## What to Do Next

---

After configuring the master switch, do the following:

1. Power off the switch by disconnecting its AC power cords from the AC power sources. Refer to Figure 91.

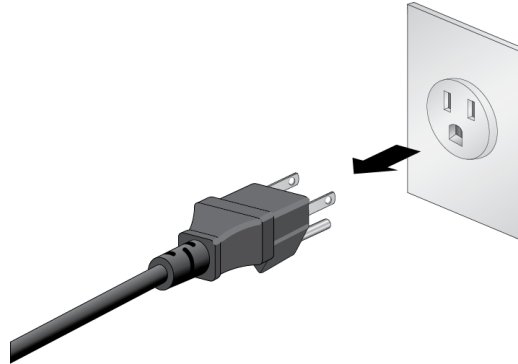

Figure 91. Powering Off the Switch

2. Configure the member switches. Refer to “Configuring the x530L-10GHXm Member Switches” on page 185 or “Configuring the x530L-18GHXm Member Switches” on page 192.
3. After configuring the master and member switches, cable the ports of the stack trunk on all the switches. Refer to “Cabling Twisted Pair Ports” on page 204.
4. Power on the master and member switches of the stack. Refer to “Powering on the Stack” on page 200.
5. Verify that the switches formed the stack by referring to “Verifying the Stack” on page 201.
6. Cable the networking ports. Refer to Chapter 9, “Cabling the Networking Ports” on page 203.

## Configuring the x530L-10GHXm Member Switches

---

Here are the procedures for configuring member switches of the stack.

- “General Steps for the x530L-10GHXm Member Switch,” next
- “Configuring x530L-10GHXm Member Switches - Part I” on page 186
- “Configuring x530L-10GHXm Member Switches - Part II” on page 188
- “Verifying x530L-10GHXm Member Switches” on page 190
- “What to Do Next” on page 199

---

### Note

The procedures require resetting the member switch twice. Some network traffic will be lost if the switch is already connected to an active network.

---

The procedures should be performed in the order presented here.

### General Steps for the x530L- 10GHXm Member Switch

The procedure for configuring member switches for stacking is divided into two parts. The general steps to Part I are listed here:

1. Start a local management session on the switch.
2. View the hardware status and management software version number with the SHOW SYSTEM ENVIRONMENT and SHOW VERSION INSTALLED commands in the Privilege Exec mode.
3. Enable the VCStack feature with the STACK ENABLE command in the Global Configuration mode. You will probably not have to perform this step because the default setting for the feature is enabled.
4. Assign an ID number in the range of 2 to 8 to the member switch with the SWITCH RENUMBER command in the Global Configuration mode.

---

### Note

Changing a member switch’s ID does not delete the default ID 1 from its configuration. Instead, the member switch retains it and uses default ID 1 as the provisioned master switch.

---

5. Save your changes with the WRITE command in the Privilege Exec mode.
6. Restart the switch with the REBOOT command.

The general steps in Part II are listed here:

1. Start a new local management session with the switch.
2. Assign the member switch a priority number equal to its ID number, with the STACK PRIORITY command in the Global Configuration mode.
3. Remove the stacking function from the default stacking ports 9 and 10, with the NO STACKPORT command.
4. Designate the ports of the stack trunk on both the provisioned master switch and member switch, with the STACKPORT command in the port Interface mode.
5. Save your changes with the WRITE command in the Privilege Exec mode.
6. Restart the switch with the REBOOT command.
7. Start a new local management session.
8. Verify the changes with the SHOW STACK and SHOW RUNNING-CONFIG command.

**Configuring  
x530L-10GHXm  
Member Switches  
- Part I**

The instructions for configuring member switches are divided into two parts. You do the following in Part I:

- Display the hardware status and management software version number.
- Enable VCStack.
- Set the switch ID number.

To configure a member switch, perform the procedure in Table 28.

Table 28. Configuring the x530L-10GHXm Member Switches - Part I

Step	Description and Command
1	Power on a member switch and wait two minutes as it initializes the management software. Refer to "Powering On a Switch" on page 135.
2	Start a local management session. Refer to "Starting a Local Management Session" on page 130.
3	Enter the ENABLE command to move from the User Exec mode to the Privileged Exec mode.  awplus> enable

Table 28. Configuring the x530L-10GHXm Member Switches - Part I (Continued)

Step	Description and Command
4	<p>Verify that the switch hardware is operating correctly, with the SHOW SYSTEM ENVIRONMENT command. All components should have the status Ok.</p> <pre>awplus# show system environment Environment Monitoring Status Overall Status: Normal Resource ID: 1 Name: x530L-10 ID Sensor (Units)      Reading      Low Limit  High Limit  Status 1 Fan: Fan 1 (RPM)      5980        4800      -           ok 2 voltage: 1.0V (Volts) 1.040       0.891     1.090      ok .</pre>
5	<p>Display the version number of the AlliedWare Plus operating software on the member switch by entering the SHOW VERSION INSTALLED command. Write down the version number in the worksheet in Table 18 on page 85. After viewing the version numbers on all the switches, you will compare them to confirm they all have the same version. Switches with different versions will have to be updated.</p>
5	<p>Move to the Global Configuration mode with the CONFIGURE TERMINAL command.</p> <pre>awplus# configure terminal Enter configuration commands, one per line. End with CNTL/Z.</pre>
<p>Step 6 enables the VCStack feature on the switch. You will probably not need to perform the step because the feature is enabled by default. If the Switch ID LED is displaying "0", perform the step. Otherwise, go to step 7.</p>	
6	<p>Activate VCStack on the switch with the STACK ENABLE command.</p> <pre>awplus(config)# stack enable % Automatically enabling 'stack virtual-mac' to minimize disruption form failovers. % Please check that the new MAC 0000.cd37.0431 is unique within the network. % Save the config and restart the system for this change to take effect.</pre>
<p>Steps 7 to 13 set the member switch's ID number, save your changes, and reboot the unit.</p>	
7	<p>Set the ID number of the member switch with the STACK RENUMBER command. If you are using the worksheet on Table 18 on page 85, refer there for the ID numbers. This example assigns the ID number 2 to the member switch.</p> <pre>awplus(config)# stack 1 renumber 2 % warning: the new ID will not become effective until the stack- member reboots. % warning: the boot configuration may now be invalid.</pre>

Table 28. Configuring the x530L-10GHXm Member Switches - Part I (Continued)

Step	Description and Command
8	Return to the Privileged Exec mode.  awplus(config)# exit
9	Enter the WRITE command to save your change. If this is the first management session, the switch adds the configuration file DEFAULT.CFG to flash memory, for storing your configuration changes.  awplus# write Building configuration ... [OK]
10	Restart the switch with the REBOOT command.  awplus# reboot reboot system? (y/n): awplus#
11	Type “Y” for yes.
12	Wait two minutes for the switch to initialize its management software.
13	Check the ID LED on the front panel and do one of the following: - If the ID LED is displaying the switch’s new ID number, go to “Configuring x530L-10GHXm Member Switches - Part II,” next. - If the ID LED is displaying a different number, repeat this procedure. Be sure to correctly enter the STACK RENUMBER command and to save your changes with the WRITE command.

### Configuring x530L-10GHXm Member Switches - Part II

This section contains instructions to the second part to configuring member switches. The instructions explain how configure the following parameters:

- Set the priority number. For background information, refer to “Selection of the Master Switch” on page 76.
- Designate the optional stacking ports for the stack trunk. Refer to “Stack Trunks of 5Gbps Ports on the x530L-10GHXm or x530L-18GHXm Switch” on page 71.

To configure a member switch, perform the procedure in Table 29.

Table 29. Configuring the x530L-10GHXm Member Switches - Part II

Step	Description and Command
1	Start a new local management session on the member switch. Refer to “Starting a Local Management Session” on page 150.



Table 29. Configuring the x530L-10GHXm Member Switches - Part II (Continued)

Step	Description and Command
2	Enter the ENABLE command to move from the User Exec mode to the Privileged Exec mode.  <pre>awplus&gt; enable</pre>
Steps 3 and 4 set the switch's priority value to be the same as its ID number.	
3	Move to the Global Configuration mode with the CONFIGURE TERMINAL command.  <pre>awplus# configure terminal</pre> Enter configuration commands, one per line. End with CNTL/Z.
4	Assign a priority value to the switch equal to its ID number, with the STACK PRIORITY. This example assigns priority 2 to a member switch with the ID 2:  <pre>awplus(config)# stack 2 priority 2</pre>
Steps 5 and 6 remove the stacking function from the default stacking ports 9 and 10 on the member switch.	
5	Enter the port Interface modes of the default stacking ports 9 and 10 on the member switch. The example here assumes the member switch has the ID 2:  <pre>awplus(config)# interface port2.0.9-2.0.10</pre> % port1.0.9 is currently configured as a stack-port. Use caution when altering its config. % port1.0.10 is currently configured as a stack-port. Use caution when altering its config.
6	Remove the stacking function from the ports to convert them into regular Ethernet ports, with the NO STACKPORT command:  <pre>awplus(config-if)# no stackport</pre> % Save the config and restart the system for this change to take effect.
Steps 7 and 8 add the stacking function to the optional stacking ports on the member switch.	
7	Enter the Interface modes of the optional stack ports on the member switch. If you filled out the worksheet in Table 18 on page 85, refer there for the ports. The example command here assumes the switch has the ID 2 and will be using ports 7 and 8 for the stack trunk. Be sure to modify the command with the ports you selected for the stack trunk.  <pre>awplus(config-if)# interface port2.0.7-2.0.8</pre>

Table 29. Configuring the x530L-10GHXm Member Switches - Part II (Continued)

Step	Description and Command
8	Designate the ports as the stack trunk with the STACKPORT command.  awplus(config-if)# stackport % Save the config and restart the system for this change to take effect.
The remaining steps save your changes and reboot the switch.	
9	Return to the Global Configuration mode.  awplus(config-if)# exit
10	Return to the Privileged Exec mode.  awplus(config)# exit
11	Save your changes with the WRITE command.  awplus# write Building configuration ... [OK]
12	Restart the switch.  awplus# reboot reboot system? (y/n):
13	Type "Y" for yes.
14	Wait two minutes for the switch to initialize its management software.
15	Go to "Verifying x530L-10GHXm Member Switches," next.

**Verifying x530L-10GHXm** Perform the steps in Table 30 to confirm the configuration of a member switch.

**Member Switches**

Table 30. Verifying the x530L-10GHXm Member Switches

Step	Description and Command
1	Start a local management session. Refer to "Starting a Local Management Session" on page 150.
2	Move to the Privileged Exec mode.  awplus> enable

Table 30. Verifying the x530L-10GHXm Member Switches (Continued)

Step	Description and Command
3	<p>Enter the SHOW STACK DETAIL command and examine the display for the entry that has the same ID number of the member switch. Here is an example for the member switch with the ID 2:</p> <pre>awplus# show stack detail . . Stack member 2: ----- ID                2 MAC address       e01a:ea20:8011 Last role change  Thur Nov 23 21:15:20 2018 Product type      x530L-10 Role              Active Master Status            Ready Priority           2 Host name         awplus S/W version auto synchronization On Resiliency link status Not configured Stack port2.0.7 status Down Stack port2.0.8 status Down . .</pre> <p>Examine the entry for the following:</p> <ul style="list-style-type: none"> <li>- The “Priority” value should be the same as the switch’s ID number. If they are not the same, repeat “Configuring x530L-10GHXm Member Switches - Part II” on page 188. Be sure to perform the STACK PRIORITY command and save your changes with the write command.</li> <li>- The “Stack port status” fields, the last two lines, should identify the selected optional stack ports. If they identify the wrong ports, such as the default ports 9 and 10, repeat “Configuring x530L-10GHXm Member Switches - Part II” on page 188. (The status of the ports is Down because the stack ports are not cabled yet.)</li> </ul>
5	Go to “What to Do Next” on page 199.

## Configuring the x530L-18GHXm Member Switches

---

Here are the procedures for configuring member switches of the stack.

- “General Steps for the x530L-18GHXm Member Switch,” next
- “Configuring x530L-18GHXm Member Switches - Part I” on page 193
- “Configuring x530L-18GHXm Member Switches - Part II” on page 195
- “Verifying x530L-18GHXm Member Switches” on page 197
- “What to Do Next” on page 199

---

### Note

The procedures require resetting the member switch twice. Some network traffic will be lost if the switch is already connected to an active network.

---

The procedures should be performed in the order presented here.

### General Steps for the x530L- 18GHXm Member Switch

The procedure for configuring member switches for stacking is divided into two parts. The general steps to Part I are listed here:

1. Start a local management session on the switch.
2. View the hardware status and management software version number with the SHOW SYSTEM ENVIRONMENT and SHOW VERSION INSTALLED commands in the Privilege Exec mode.
3. Enable the VCStack feature with the STACK ENABLE command in the Global Configuration mode. You will probably not have to perform this step because the default setting for the feature is enabled.
4. Assign an ID number in the range of 2 to 8 to the member switch with the SWITCH RENUMBER command in the Global Configuration mode.

---

### Note

Changing a member switch’s ID does not delete the default ID 1 from its configuration. Instead, the member switch retains it and uses default ID 1 as the provisioned master switch.

---

5. Save your changes with the WRITE command in the Privilege Exec mode.
6. Restart the switch with the REBOOT command.

The general steps in Part II are listed here:

1. Start a new local management session with the switch.
2. Assign the member switch a priority number equal to its ID number, with the STACK PRIORITY command in the Global Configuration mode.
3. Remove the stacking function from the default stacking ports 9 and 10, with the NO STACKPORT command.
4. Designate the ports of the stack trunk on both the provisioned master switch and member switch, with the STACKPORT command in the port Interface mode.
5. Save your changes with the WRITE command in the Privilege Exec mode.
6. Restart the switch with the REBOOT command.
7. Start a new local management session.
8. Verify the changes with the SHOW STACK and SHOW RUNNING-CONFIG command.

### **Configuring x530L-18GHXm Member Switches - Part I**

The instructions for configuring member switches are divided into two parts. You do the following in Part I:

- Display the hardware status and management software version number.
- Enable VCStack.
- Set the switch ID number.

To configure a member switch, perform the procedure in Table 28.

Table 31. Configuring the x530L-18GHXm Member Switches - Part I

<b>Step</b>	<b>Description and Command</b>
1	Power on a member switch and wait two minutes as it initializes the management software. Refer to "Powering On a Switch" on page 135.
2	Start a local management session. Refer to "Starting a Local Management Session" on page 130.
3	Enter the ENABLE command to move from the User Exec mode to the Privileged Exec mode.  awplus> enable

Table 31. Configuring the x530L-18GHXm Member Switches - Part I (Continued)

Step	Description and Command
4	<p>Verify that the switch hardware is operating correctly, with the SHOW SYSTEM ENVIRONMENT command. All components should have the status Ok.</p> <pre>awplus# show system environment Environment Monitoring Status Overall Status: Normal Resource ID: 1 Name: x530L-10 ID Sensor (Units)      Reading      Low Limit  High Limit  Status 1 Fan: Fan 1 (RPM)      5980        4800       -           ok 2 voltage: 1.0V (Volts) 1.040        0.891      1.090      ok .</pre>
5	<p>Display the version number of the AlliedWare Plus operating software on the member switch by entering the SHOW VERSION INSTALLED command. Write down the version number in the worksheet in Table 18 on page 85. After viewing the version numbers on all the switches, you will compare them to confirm they all have the same version. Switches with different versions will have to be updated.</p>
5	<p>Move to the Global Configuration mode with the CONFIGURE TERMINAL command.</p> <pre>awplus# configure terminal Enter configuration commands, one per line. End with CNTL/Z.</pre>
<p>Step 6 enables the VCStack feature on the switch. You will probably not need to perform the step because the feature is enabled by default. If the Switch ID LED is displaying "0", perform the step. Otherwise, go to step 7.</p>	
6	<p>Activate VCStack on the switch with the STACK ENABLE command.</p> <pre>awplus(config)# stack enable % Automatically enabling 'stack virtual-mac' to minimize disruption form failovers. % Please check that the new MAC 0000.cd37.0431 is unique within the network. % Save the config and restart the system for this change to take effect.</pre>
<p>Steps 7 to 13 set the member switch's ID number, save your changes, and reboot the unit.</p>	
7	<p>Set the ID number of the member switch with the STACK RENUMBER command. If you are using the worksheet on Table 18 on page 85, refer there for the ID numbers. This example assigns the ID number 2 to the member switch.</p> <pre>awplus(config)# stack 1 renumber 2 % warning: the new ID will not become effective until the stack- member reboots. % warning: the boot configuration may now be invalid.</pre>

Table 31. Configuring the x530L-18GHXm Member Switches - Part I (Continued)

Step	Description and Command
8	Return to the Privileged Exec mode.  awplus(config)# exit
9	Enter the WRITE command to save your change. If this is the first management session, the switch adds the configuration file DEFAULT.CFG to flash memory, for storing your configuration changes.  awplus# write Building configuration ... [OK]
10	Restart the switch with the REBOOT command.  awplus# reboot reboot system? (y/n): awplus#
11	Type “Y” for yes.
12	Wait two minutes for the switch to initialize its management software.
13	Check the ID LED on the front panel and do one of the following: - If the ID LED is displaying the switch’s new ID number, go to “Configuring x530L-10GHXm Member Switches - Part II,” next. - If the ID LED is displaying a different number, repeat this procedure. Be sure to correctly enter the STACK RENUMBER command and to save your changes with the WRITE command.

### Configuring x530L-18GHXm Member Switches - Part II

This section contains instructions to the second part to configuring member switches. The instructions explain how configure the following parameters:

- Set the priority number. For background information, refer to “Selection of the Master Switch” on page 76.
- Designate the optional stacking ports for the stack trunk. Refer to “Stack Trunks of 5Gbps Ports on the x530L-10GHXm or x530L-18GHXm Switch” on page 71.

To configure a member switch, perform the procedure in Table 29.

Table 32. Configuring the x530L-18GHXm Member Switches - Part II

Step	Description and Command
1	Start a new local management session on the member switch. Refer to “Starting a Local Management Session” on page 150.

Table 32. Configuring the x530L-18GHXm Member Switches - Part II (Continued)

Step	Description and Command
2	Enter the ENABLE command to move from the User Exec mode to the Privileged Exec mode.  <pre>awplus&gt; enable</pre>
Steps 3 and 4 set the switch's priority value to be the same as its ID number.	
3	Move to the Global Configuration mode with the CONFIGURE TERMINAL command.  <pre>awplus# configure terminal</pre> Enter configuration commands, one per line. End with CNTL/Z.
4	Assign a priority value to the switch equal to its ID number, with the STACK PRIORITY. This example assigns priority 2 to a member switch with the ID 2:  <pre>awplus(config)# stack 2 priority 2</pre>
Steps 5 and 6 remove the stacking function from the default stacking ports 9 and 10 on the member switch.	
5	Enter the port Interface modes of the default stacking ports 17 and 18 on the member switch. The example here assumes the member switch has the ID 2:  <pre>awplus(config)# interface port2.0.17-2.0.18</pre> % port1.0.17 is currently configured as a stack-port. Use caution when altering its config. % port1.0.18 is currently configured as a stack-port. Use caution when altering its config.
6	Remove the stacking function from the ports to convert them into regular Ethernet ports, with the NO STACKPORT command:  <pre>awplus(config-if)# no stackport</pre> % Save the config and restart the system for this change to take effect.
Steps 7 and 8 add the stacking function to the optional stacking ports on the member switch.	
7	Enter the Interface modes of the optional stack ports on the member switch. If you filled out the worksheet in Table 18 on page 85, refer there for the ports. The example command here assumes the switch has the ID 2 and will be using ports 15 and 16 for the stack trunk. Be sure to modify the command with the ports you selected for the stack trunk.  <pre>awplus(config-if)# interface port2.0.15-2.0.16</pre>



Table 32. Configuring the x530L-18GHXm Member Switches - Part II (Continued)

Step	Description and Command
8	Designate the ports as the stack trunk with the STACKPORT command.  awplus(config-if)# stackport % Save the config and restart the system for this change to take effect.
The remaining steps save your changes and reboot the switch.	
9	Return to the Global Configuration mode.  awplus(config-if)# exit
10	Return to the Privileged Exec mode.  awplus(config)# exit
11	Save your changes with the WRITE command.  awplus# write Building configuration ... [OK]
12	Restart the switch.  awplus# reboot reboot system? (y/n):
13	Type "Y" for yes.
14	Wait two minutes for the switch to initialize its management software.
15	Go to "Verifying x530L-18GHXm Member Switches," next.

**Verifying x530L-18GHXm** Perform the steps in Table 33 to confirm the configuration of a member switch.

### Member Switches

Table 33. Verifying the x530L-18GHXm Member Switches

Step	Description and Command
1	Start a local management session. Refer to "Starting a Local Management Session" on page 150.
2	Move to the Privileged Exec mode.  awplus> enable

Table 33. Verifying the x530L-18GHXm Member Switches (Continued)

Step	Description and Command
3	<p>Enter the SHOW STACK DETAIL command and examine the display for the entry that has the same ID number of the member switch. Here is an example for the member switch with the ID 2:</p> <pre>awplus# show stack detail . . Stack member 2: ----- ID                2 MAC address       e01a:ea20:8011 Last role change  Thur Nov 23 21:15:20 2018 Product type      x530L-18 Role              Active Master Status            Ready Priority           2 Host name         awplus S/W version auto synchronization On Resiliency link status Not configured Stack port2.0.15 status Down Stack port2.0.16 status Down . .</pre> <p>Examine the entry for the following:</p> <ul style="list-style-type: none"> <li>- The “Priority” value should be the same as the switch’s ID number. If they are not the same, repeat “Configuring x530L-18GHXm Member Switches - Part II” on page 195. Be sure to perform the STACK PRIORITY command and save your changes with the write command.</li> <li>- The “Stack port status” fields, the last two lines, should identify the selected optional stack ports. If they identify the wrong ports, such as the default ports 17 and 18, repeat “Configuring x530L-18GHXm Member Switches - Part II” on page 195. (The status of the ports is Down because the stack ports are not cabled yet.)</li> </ul>
5	Go to “What to Do Next” on page 199.

## What to Do Next

---

After configuring a member switch, do the following:

1. Power off the switch by disconnecting its AC power cords from the AC power sources. Refer to Figure 91 on page 184.
2. Repeat this procedure to configure any additional member switches.
3. If you have not already configured the master switch, perform “Configuring the Master x530L-10GHXm Switch” on page 166 or “Configuring the Master x530L-18GHXm Switch” on page 175.
4. Cable the 5Gbps ports of the stack trunk, on the master and member switches. Refer to “Cabling Twisted Pair Ports” on page 204.

---

**Note**

When cabling the stack trunk, remember that the cables must crossover to different ports. For example, if you are using ports 17 and 18 for the stack trunk, port 17 on a switch has to connect to port 18 on the next switch.

---

5. Power on the master and member switches of the stack, as explained in “Powering on the Stack” on page 200.
6. Verify that the switches successfully formed the stack by performing “Verifying the Stack” on page 201.
7. Cable the networking ports, as explained in Chapter 9, “Cabling the Networking Ports” on page 203.

## Powering on the Stack

---

After configuring the master and member switches, you are ready to cable the 5 Gbps ports of the stack trunk and power on the stack for the first time. (If you want to monitor the power-on sequence, connect a terminal or computer with a terminal emulator program to the Console port on either switch.)

To power on the stack for the first time, perform the following procedure:

1. Verify that the master and member switches are powered off.
2. Cable the 5 Gbps ports of the stack trunk on the switches. Refer to “Cabling Twisted Pair Ports” on page 204.
3. Power on all the switches at the same time or within thirty seconds of each other. Refer to “Powering on the Stack” on page 200.

Refer to “Power Specifications” on page 221 for the power specifications of the switches.



### **Warning**

Power cord is used as a disconnection device. To de-energize equipment, disconnect the power cord. ⚡ E3

---

### **Note**

Pluggable Equipment. The socket outlet shall be installed near the equipment and shall be easily accessible. ⚡ E5

---

4. Wait two minutes for the switches to form the stack.
5. Go to “Verifying the Stack” on page 201.

## Verifying the Stack

To verify the stack, perform the following procedure:

1. Start a local management session on any switch in the stack. Refer to “Starting a Local Management Session” on page 150.
2. From the User Exec mode, type the SHOW STACK command:

```
awplus> show stack
```

The following example is from a stack of three switches:

```
awplus> show stack
Virtual Chassis Stacking summary information
ID      Pending ID      MAC address      Priority      Status      Role
1       -                e01a:ea20:8011  1            Ready      Active Master
2       -                e01a:ea20:8012  2            Ready      Member
3       -                e01a:ea20:8902  3            Ready      Member
Operational Status      Normal operations
```

Review the following items:

- The command should list all the switches. If the list is incomplete, refer to Chapter 10, “Troubleshooting” on page 211.
  - The Operational Status field should be “Normal operations” to indicate that all the stacking ports are operating normally.
  - If the Operational Status field is displaying “Not all stack ports are up,” one or more stacking ports are not being used or cannot establish links with their counterparts. For more information, refer to Chapter 10, “Troubleshooting” on page 211.
3. Go to Chapter 9, “Cabling the Networking Ports” on page 203, to complete the installation.



## Chapter 9

# Cabling the Networking Ports

---

This chapter contains the following procedures:

- ❑ “Cabling Twisted Pair Ports” on page 204
- ❑ “Guidelines to Handling SFP and SFP+ Transceivers” on page 205
- ❑ “Installing SFP or SFP+ Transceivers in the Switches” on page 206
- ❑ “Installing SP10TW Direct Connect Twinax Cables in the Switches” on page 208

## Cabling Twisted Pair Ports

---

Here are the guidelines to cabling the twisted pair ports on the switches:

- ❑ Minimum twisted pair cable requirements are as follows:
  - 10/100Mbps ports: Standard TIA/EIA 568-B-compliant Category 3 unshielded cabling
  - 1Gbps ports: Standard TIA/EIA 568-A-compliant Category 5 or TIA/EIA 568-B-compliant Enhanced Category 5 (Cat 5e)
  - 2.5/5Gbps ports: Standard TIA/EIA 568-A-compliant Category 6 or TIA/EIA 568-B-compliant Category 6A (Cat 6A) unshielded cabling
- ❑ PoE is enabled by default on the x530L-10GHXm, x530L-18GHXm, x530L-28GPX and x530L-52GPX switch ports.
- ❑ The connectors on the cables must fit snugly into the ports, and the tabs must lock the connectors into place.
- ❑ The default speed setting for the ports is Auto-Negotiation. This setting is appropriate for ports connected to network devices that also support Auto-Negotiation.
- ❑ The ports must be set to the default setting of Auto-Negotiation to operate at 1Gbps.
- ❑ The twisted pair ports can operate in either half- or full-duplex mode when operating at 10/100Mbps. However, if any of the twisted pair ports operate at 1Gbps or higher, then the duplex mode is always full-duplex.
- ❑ Do not attach cables to ports of static or Link Aggregation Control Protocol (LACP) port trunks until after you configure the trunks on the switch. Otherwise, the ports will form network loops that can adversely affect network performance.



## Guidelines to Handling SFP and SFP+ Transceivers

---

Review the following guidelines before installing SFP or SFP+ transceivers in the switches:

- ❑ The transceivers are hot-swappable. You can install them while the switch is powered on.
- ❑ For a list of supported transceivers, refer to the product data sheet on the Allied Telesis web site.
- ❑ The operational specifications and fiber optic cable requirements of the transceivers are provided in the documents included with the devices.
- ❑ Install a transceiver before connecting the fiber optic cable.
- ❑ Unnecessary removal and insertion of a transceiver can lead to premature failure.



### Caution

Transceivers can be damaged by static electricity. Be sure to observe all standard electrostatic discharge (ESD) precautions, such as wearing an antistatic wrist strap, to avoid damaging the devices. *ES* E92

---

## Installing SFP or SFP+ Transceivers in the Switches

---

This section contains installation instructions for SFP or SFP+ transceivers in:

- ❑ x530L-10GHXm ports 9 and 10
- ❑ x530L-18GHXm ports 17 and 18
- ❑ x530L-28GTX and x530L-28GPX ports 25 to 28
- ❑ x530L-52GTX and x530L-52GPX ports 49 to 52

The following illustrations show a transceiver with a duplex LC connector. The connectors on your transceivers may be different.

To install transceivers, perform the following procedure:

1. Select a port for the transceiver.
2. Remove the transceiver from its shipping container and store the packaging material in a safe location.
3. If you are installing the transceiver in a top port, position the transceiver with the Allied Telesis label facing up. If you are installing the transceiver in a bottom port, position the transceiver with the label facing down. Refer to Figure 92.

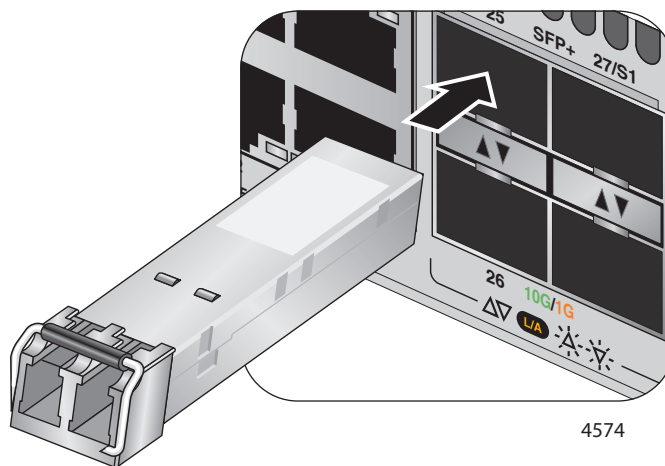
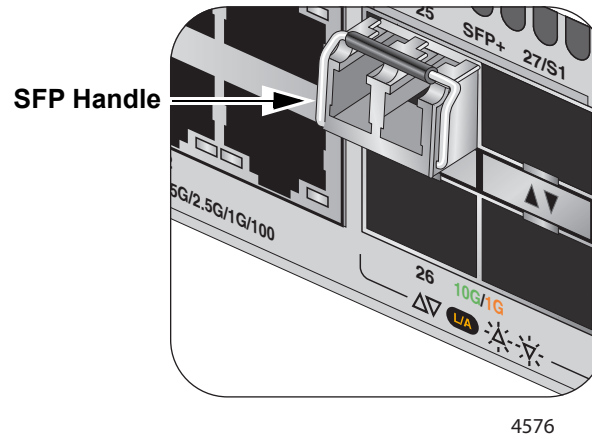

Figure 92. Installing an SFP Transceiver

4. Slide the transceiver into the port until it clicks into place.

5. Verify the position of the handle on the transceiver. If the transceiver is in a top port, the handle must be in the upright position, as shown in Figure 93. If the transceiver is in a bottom port, the handle must be in the down position.



4576

Figure 93. Positioning the SFP or SFP+ Handle in the Upright Position

---

**Note**

If you are ready to attach the fiber optic cable to the transceiver, continue with the next step. Otherwise, repeat steps 1 through 5 to install the remaining transceivers in the switch.

---

6. Connect the fiber optic cable to the transceiver, as shown in Figure 94. The connector on the cable must fit snugly into the port, and the tab must lock the connector into place.

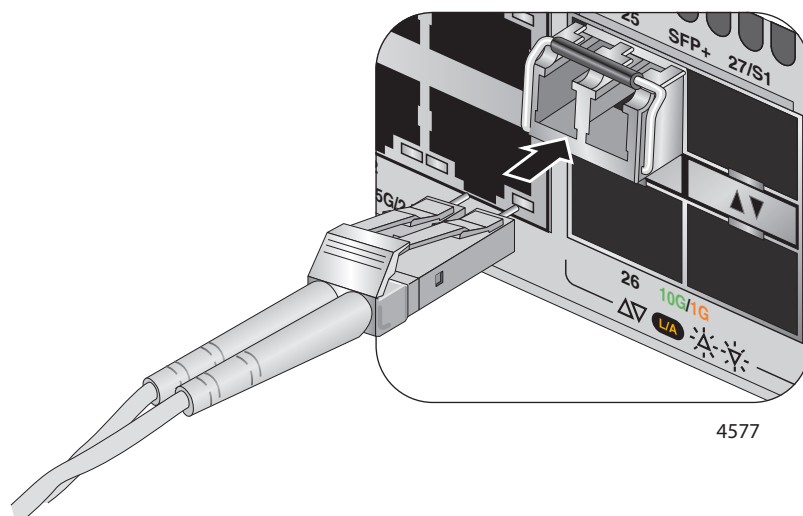

4577

Figure 94. Connecting a Fiber Optic Cable to an SFP or SFP+ Transceiver

7. Repeat this procedure to install additional transceivers.

## **Installing SP10TW Direct Connect Twinax Cables in the Switches**

---

The SFP/SFP+ transceiver ports of the switches support SP10TW1 and SP10TW3 direct connect twinax cables. They come in lengths of 1 and 3 meters, respectively, and have SFP+ transceivers on both ends. The cables are an economical way to add 10 Gbps connections over short distances.

To install SP10TW cables in the switch, perform the following procedure:

1. Select a port for the transceiver.
2. Remove the transceiver from its shipping container and store the packaging material in a safe location.
3. To install the transceiver in a port in the top row, position the transceiver with the Allied Telesis label facing up. To install the transceiver in a port in the bottom row, position the transceiver with the label facing down. Refer to Figure 95.

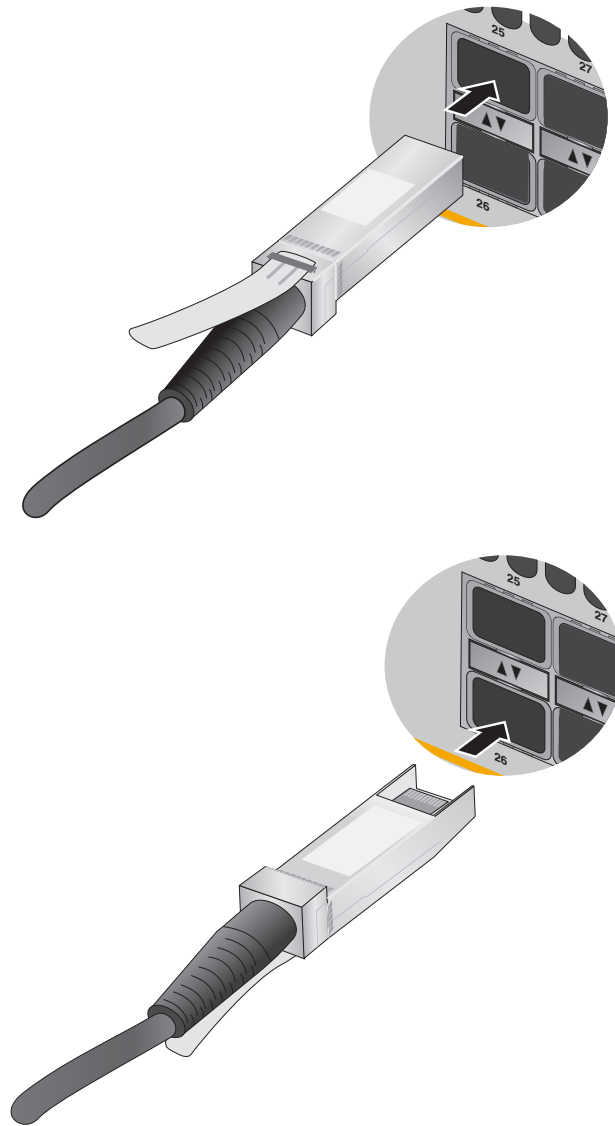

Figure 95. Installing SP10TW Cables

4. Slide the transceiver into the port until it clicks into place.
5. Connect the other end of the cable into an SFP+ port on another network device.
6. Repeat this procedure to install additional transceivers.

---

**Note**

To remove the connector and cable from the port, gently push on the connector, pull on the release tab, and slide the connector from the port.

---



## Chapter 10

# Troubleshooting

---

This chapter contains suggestions on how to troubleshoot problems with the switch.

---

**Note**

For further assistance, please contact Allied Telesis Technical Support at [www.alliedtelesis.com/support](http://www.alliedtelesis.com/support).

---

**Problem 1:** All the port LEDs and Switch ID LED are off, and the fans are not operating.

**Solutions:** The unit is not receiving power. Try the following:

- Verify that the power cord is securely connected to the power source and the AC connector on the back panel of the switch.
- Verify that the power outlet has power by connecting another device to it.
- Try connecting the unit to another power source.
- Try a different power cord.
- Verify that the voltage from the power source is within the required levels for your region. The power requirements for the switch are listed in Chapter 7, “Building the Trunk with the Default 10Gbps Stacking Ports” on page 141.

**Problem 2:** All of the port LEDs are off even though the ports are connected to active network devices.

**Solution:** The switch might be operating in the low power mode. To toggle on the LEDs, press the eco-friendly button on the front panel of the switch. You can also toggle the LEDs off and on with the ECOFRIENDLY LED and NO ECOFRIENDLY LED commands in the command line interface.

**Problem 3:** A twisted pair port on the switch is connected to an active network device but the port's LINK/ACT LED is off.

**Solutions:** The port is unable to establish a link to a network device. Try the following:

- ❑ Verify that the network device connected to the twisted pair port is powered on and is operating properly.
- ❑ Try connecting another network device to the twisted pair port with a different cable. If the twisted pair port is able to establish a link, then the problem is with the cable or the other network device.
- ❑ Verify that the twisted pair cable does not exceed 100 meters (328 feet).
- ❑ Verify that you are using the appropriate category of twisted pair cable. Refer to "Cable Requirements" on page 33.
- ❑ Verify that the port is connected to the correct twisted pair cable.

---

**Note**

Twisted pair ports may require five to ten seconds to establish a link.

---

**Problem 4:** The LINK/ACT LED for an SFP or SFP+ transceiver is off.

**Solutions:** The fiber optic port on the transceiver is unable to establish a link to a network device. Try the following:

- ❑ Verify that the remote network device connected to the fiber optic port is operating properly.
- ❑ Verify that the fiber optic cable is securely connected to the port on the transceiver and to the port on the remote network device.
- ❑ Check that the transceiver is fully inserted in the port.
- ❑ Verify that the operating specifications of the fiber optic ports on the transceiver and remote network device are compatible.
- ❑ Verify that the correct type of fiber optic cabling is being used.
- ❑ Verify that the port is connected to the correct fiber optic cable.
- ❑ Try connecting another network device to the fiber optic port using a different cable. If the port is able to establish a link, then the problem is with the cable or with the other network device.
- ❑ Use the switch management software to verify that the port is enabled.
- ❑ If the remote network device is a managed device, use the management firmware to determine whether the port is enabled.
- ❑ Test the attenuation of both directions on the fiber optic cable with a fiber optic tester to determine whether the optical signal is too weak (sensitivity) or too strong (maximum input power).



**Problem 5:** The SHOW STACK command is not displaying all the switches in the stack.

**Solutions:** If you are using 10Gbps ports for the stack trunk, try the following:

- ❑ Verify that the stacking ports are properly cabled. Refer to Chapter 9, “Cabling the Networking Ports” on page 203.
- ❑ If you are using SFP+ transceivers for the stack trunk, verify that they are fully inserted into the transceiver ports.
- ❑ If you are using AT-SP10TW direct connect twinax cables, verify that they are from Allied Telesis. The trunk will not work with cables from other network equipment manufacturers.
- ❑ Verify that the VCStack is activated on the switches. For instructions refer to “Verifying the Stack” on page 153.

**Problem 6:** The x530L-10GHXm, x530L-18GHXm, x530L-28GPX or x530L-52GPX switch is not providing power to a PoE device.

**Solutions:** Try the following:

- ❑ Review the powered device's documentation to verify that it is compatible with the switch. Refer to “Powered Device Classes” on page 43 and “Wiring Implementation” on page 45.
- ❑ Use the SHOW SYSTEM ENVIRONMENT command to confirm that both power supplies are operating normally.
- ❑ Use the management software to determine whether the switch has reached its maximum power, and so cannot support any further powered devices.
- ❑ Verify that you are using the appropriate category of twisted-pair cable.
- ❑ Use the management software on the switch to determine whether PoE is enabled on the port. The default setting for PoE is enabled.
- ❑ Use the management software on the switch to determine whether the PoE power setting for the port has been reduced to a value below the power requirements of the device.
- ❑ Try connecting the device to a different port on the switch.

**Problem 7:** The switch functions intermittently.

**Solutions:** Check the system hardware status through the management software:

- ❑ Use the SHOW SYSTEM ENVIRONMENT command in the Privileged Exec mode to verify that the input voltage from the power source to the switch is stable and within the approved operating range. The unit will shut down if the input voltage fluctuates above or below the approved operating range.
- ❑ Use the SHOW SYSTEM ENVIRONMENT command in the Privileged Exec mode to verify that the fan is operating correctly.
- ❑ Verify that the location of the switch allows for adequate airflow. The unit will shut down if it is overheating.

**Problem 8:** The Switch ID LED on the front of the switch is flashing the letter “F.”

**Solutions:** One or more of the following problems has occurred:

- ❑ A cooling fan has failed.
- ❑ The switch might be overheating and may have to shut down.

Contact your Allied Telesis sales representative for assistance.

## Appendix A

# Technical Specifications

---

This appendix contains the following sections:

- "Physical Specifications" on page 216
- "Environmental Specifications" on page 220
- "Power Specifications" on page 221
- "Certifications" on page 223
- "RJ-45 Twisted Pair Port Pinouts" on page 224
- "RJ-45 Style Serial Console Port Pinouts" on page 226
- "USB Port" on page 227

# Physical Specifications

## Dimensions

Table 34 lists the dimensions of the switches. Figure 98 through Figure 101 on page 218 illustrate the dimensions of the switches.

Table 34. Product Dimensions

Model	Dimension (W x H x D)
x530L-10GHXm	21.03 cm x 4.24 cm x 36.14 cm (8.28 in. x 1.67 in. x 14.23 in.)
x530L-18GHXm	44.05 cm x 4.37 cm x 25.53 cm (17.34 in. x 1.72 in. x 10.5 in.)
x530L-28GTX	44.05 cm x 4.37 cm x 32.26 cm (17.344 in. x 1.72 in. x 12.7 in.)
x530L-28GPX	44.05 cm x 4.37 cm x 42.06cm (17.344 in. x 1.72 in. x 16.56 in.)
x530L-52GTX	44.05 cm x 4.37 cm x 32.26 cm (17.344 in. x 1.72 in. x 12.7 in.)
x530L-52GPX	44.05 cm x 4.37 cm x 42.06 cm (17.344 in. x 1.72 in. x 16.56 in.)

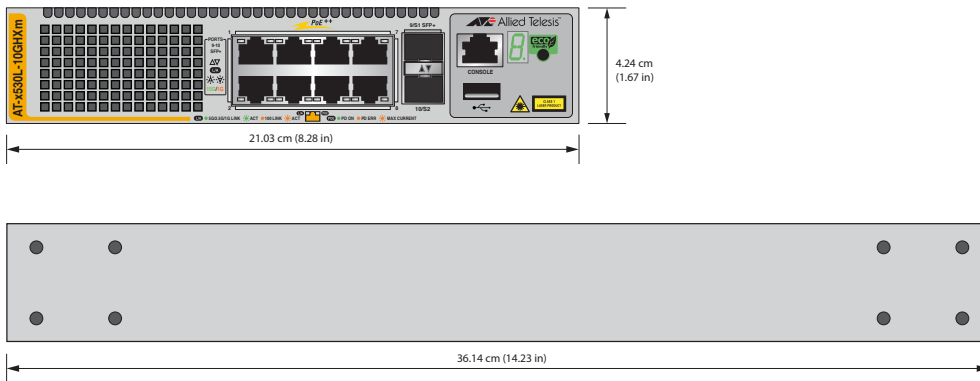

Figure 96. x530L-10GHXm

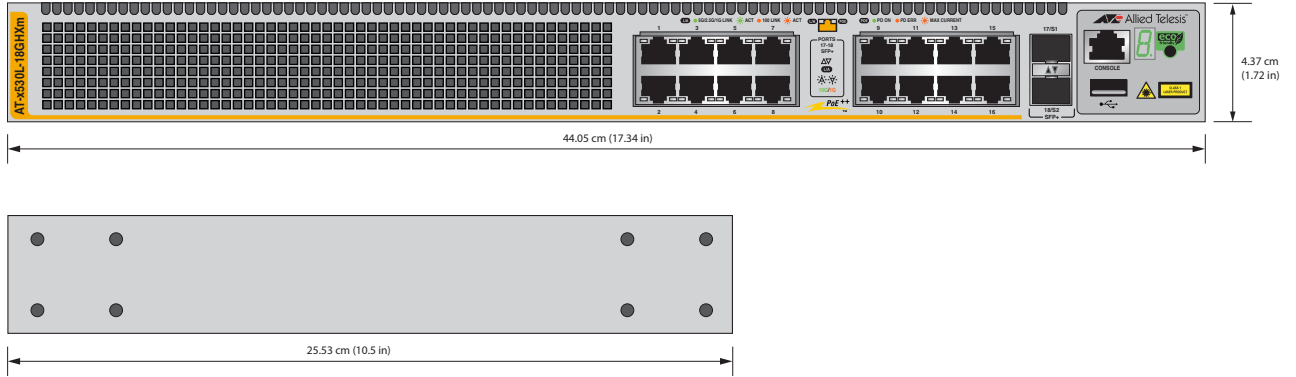

Figure 97. x530L-18GHXm

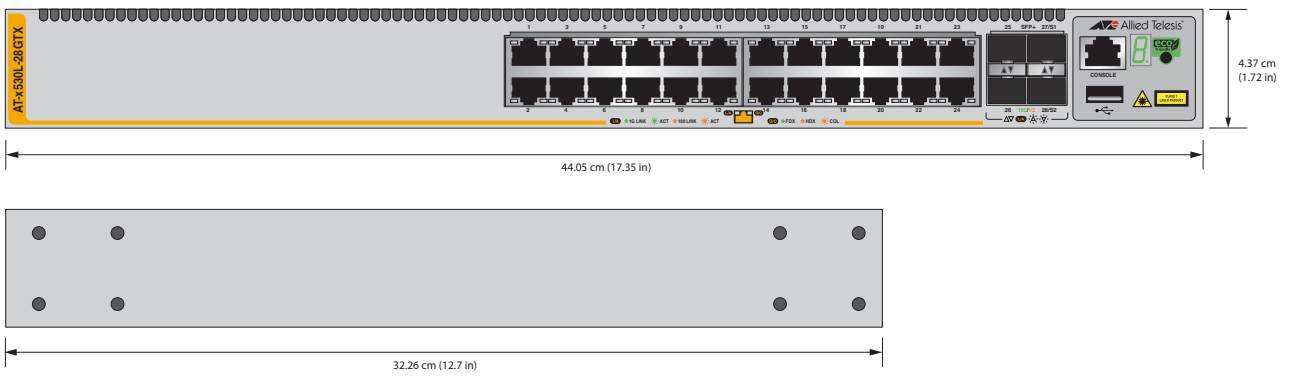

Figure 98. x530L-28GTX

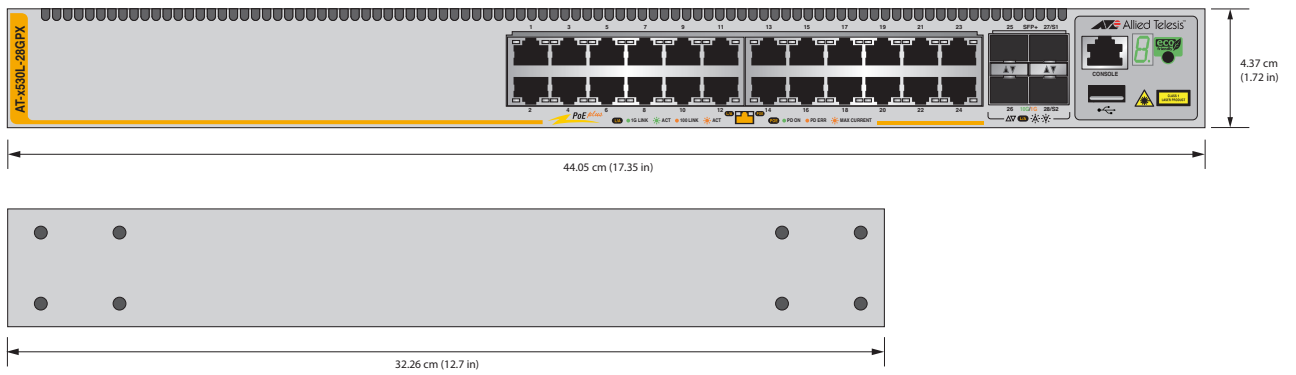

Figure 99. x530L-28GPX

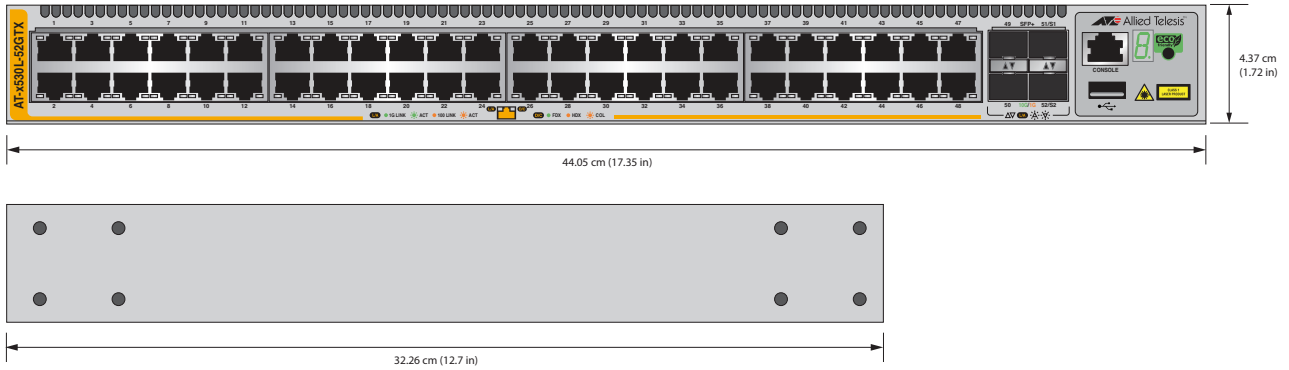

Figure 100. x530L-52GTX

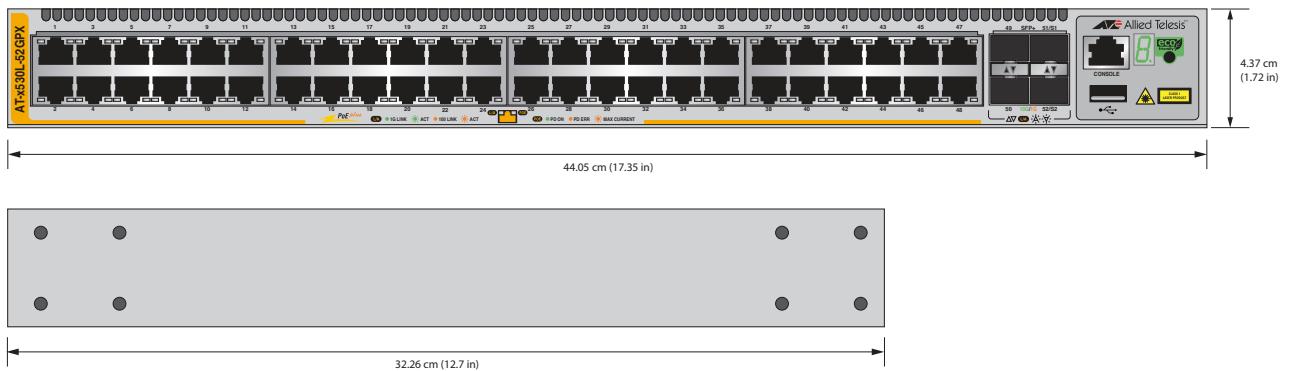

Figure 101. x530L-52GPX

## Weights

Table 35 lists the weights of the switches.

Table 35. Product Weights

x530L-10GHXm	3.20 kg (7.00 lb)
x530L-18GHXm	4.28 kg (9.45 lb)
x530L-28GTX with ATKK60W PSU	4.36 kg (9.60 lb)
x530L-28GPX	5.44 kg (12.00 lb)
x530L-52GTX with ADP150W PSU	5.19 kg (11.45 lb)
x530L-52GPX	6.71 kg (14.80 lb)

## Ventilation

Table 36 lists the ventilation requirements.

Table 36. Ventilation Requirements

Recommended Minimum Ventilation on All Sides	10 cm (4.0 in)
--	----------------

## Environmental Specifications

---

Table 37 lists the environmental specifications of the switches.

Table 37. Environmental Specifications

Operating Temperature	0° C to 50° C (32° F to 122° F)
Storage Temperature	-25° C to 70° C (-13° F to 158° F)
Operating Humidity	5% to 90% noncondensing
Storage Humidity	5% to 95% noncondensing
Maximum Operating Altitude	3,000 m (9,842 ft)
Maximum Nonoperating Altitude	4,000 m (13,100 ft)
Product Noise Level	More than 42 dB @ 30C or less
Installation Requirement	Tabletop, wall or rack mount



## Power Specifications

---

This section contains the maximum power consumption values, input voltages, and heat dissipation values.

### Maximum Power Consumption

Table 38 lists the maximum power consumption for the switches.

Table 38. Maximum Power Consumption

x530L-10GHXm	549 W (1 PSU)
x530L-18GHXm	910 W (1 PSU)
x530L-28GTX	39 W (1 or 2 PSUs)
x530L-28GPX	470 W (1 PSU) 890 W (2 PSU)
x530L-52GTX	60 W (1 or 2 PSUs)
x530L-52GPX	520 W (1 PSU) 950 W (2 PSU)

### Input Voltages

Table 39 lists the input voltage for the switches.

Table 39. Input Voltage

x530L-10GHXm	100-240 VAC, 50/60 Hz, 8 A
x530L-18GHXm	100-240 VAC, 50/60 Hz, 10 A
x530L-28GTX	100-240 VAC, 50/60 Hz, 1 A
x530L-28GPX	100-240 VAC, 50/60 Hz, 6 A (per input) (x2)
x530L-52GTX	100-240 VAC, 50/60 Hz, 1 A
x530L-52GPX	100-240 VAC, 50/60 Hz, 6 A (per input) (x2)

## Heat Dissipation

Table 40 lists the heat dissipation for the switches.

Table 40. Heat Dissipation

x530L-10GHXm	2116 BTU/hr (1 PSU)
x530L-18GHXm	3105.5 BTU/hr (1 PSU)
x530L-28GTX	133.09 BTU/hr (1 or 2 PSUs)
x530L-28GPX	1603 BTU/hr (1 PSU) 3037 BTU/hr (2 PSU)
x530L-52GTX	204.75 BTU/hr (1 or 2 PSUs)
x530L-52GPX	1774.49 BTU/hr (1 PSU) 3241.86 BTU/hr (2 PSU)

## Certifications

---

Table 41 lists the product certificates.

Table 41. Product Certifications

EMI (RFI Emissions)	FCC Class A, EN55032 Class A, EN61000-3-2, EN61000-3-3, VCCI Class A, RCM
EMC (Immunity)	EN55024
Electrical and Laser Safety	EN62368-1 (TUV), UL 60950-1 (cUL <sub>US</sub> ), CSA-C22-2 No. 60950-1 (cUL <sub>US</sub> ), EN60825-1 (TUV), UL 62368-1
Compliance Marks	CE, cUL <sub>US</sub> , TUV
RoHS and WEEE	Complies with RoHS 6 Complies with China RoHS

## RJ-45 Twisted Pair Port Pinouts

Figure 102 illustrates the pin layout of the RJ-45 connectors on the front panel of the switch.

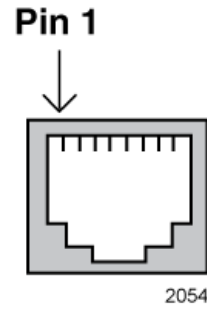

Figure 102. RJ-45 Socket Pin Layout (Front View)

Table 42 and Table 43 on page 225 list the pin signals.

Table 42. Pin Signals at 10M/100M

Pin	10Mbps/ 100Mbps MDI Signal	10Mbps/ 100Mbps MDI-X Signal
1	TX+	RX+
2	TX-	RX-
3	RX+	TX+
4	Not used	Not used
5	Not used	Not used
6	RX-	TX-
7	Not used	Not used
8	Not used	Not used

Table 43. Pin Signals at 1Gbps

<b>Pin</b>	<b>1Gbps MDI Signal</b>	<b>1Gbps MDI-X Signal</b>
1	BI_DA+	BI_DB+
2	BI_DA-	BI_DB-
3	BI_DB+	BI_DA+
4	BI_DC+	BI_DD+
5	BI_DC-	BI_DD-
6	BI_DB-	BI_DA-
7	BI_DD+	BI_DC+
8	BI_DD-	BI_DC-

## RJ-45 Style Serial Console Port Pinouts

---

Table 44 lists the pin signals of the RJ-45 style serial console port.

Table 44. RJ-45 Style Serial Console Port Pin Signals

<b>Pin</b>	<b>Signal</b>
1	RTS#
2	Not used
3	Transmit Data
4	Ground
5	Ground
6	Receive Data
7	Not used
8	CTS

## USB Port

---

Table 45 lists the pin signals of the USB port.

Table 45. USB Port Pin Signals

<b>Pin</b>	<b>Signal</b>
1	+5V
2	DATA-
3	DATA+
X	NC
4	GND

