

SWITCHBLADE LINE CARD

QUICK INSTALL GUIDE

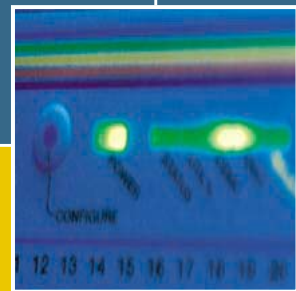
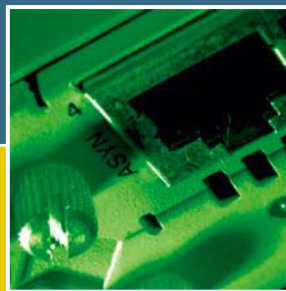
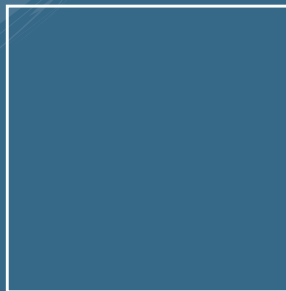

SwitchBlade Line Card Quick Install Guide
Document Number C613-04030-01 REV E1.

Copyright © 2002-2003 Allied Telesyn International, Corp. 19800 North Creek Parkway,
Suite 200, Bothell, WA 98011, USA.

All rights reserved. No part of this publication may be reproduced without prior written permission from Allied Telesyn.

Allied Telesyn International, Corp. reserves the right to make changes in specifications and other information contained in this document without prior written notice. The information provided herein is subject to change without notice. In no event shall Allied Telesyn be liable for any incidental, special, indirect, or consequential damages whatsoever, including but not limited to lost profits, arising out of or related to this manual or the information contained herein, even if Allied Telesyn has been advised of, known, or should have known, the possibility of such damages.

All trademarks are the property of their respective owners.

Documentation Roadmap

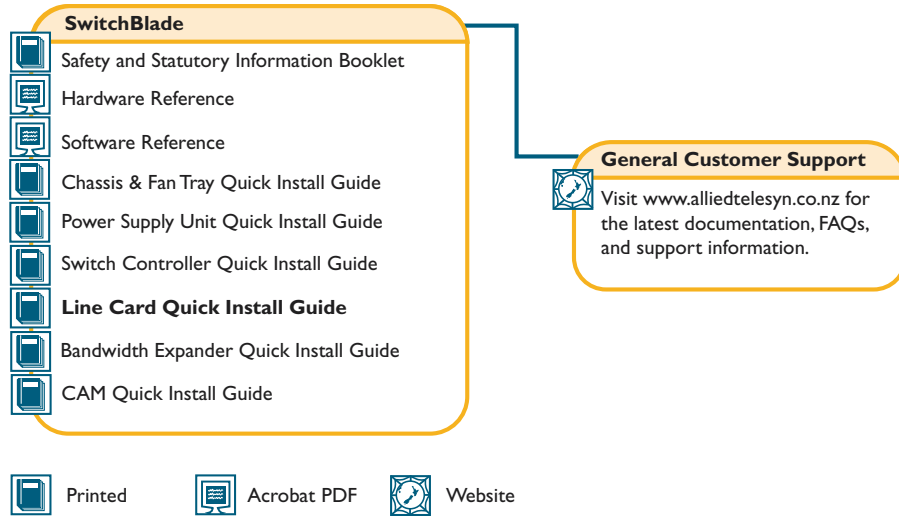

Models Covered By This Guide

This Quick Install Guide includes information on installing the following line cards:

- AT-SB4311 48-port 10BASE-T/100BASE-TX (RJ-45)
- AT-SB4352 32-port 100BASE-FX (MT-RJ)
- AT-SB4411 8-port 10BASE-T/100BASE-TX/1000BASE-T (RJ-45)
- AT-SB4412 24-port 10BASE-T/100BASE-TX/1000BASE-T (RJ-45)
- AT-SB4441 8-port 1000BASE-X (GBIC)
- AT-SB4451 8-port 1000BASE-SX (SC)
- AT-SB4452 8-port 1000BASE-SX (MT-RJ)
- AT-SB4461 8-port 1000BASE-LX (SC)
- AT-SB4462 8-port 1000BASE-LX (MT-RJ)

Information on installing switch controllers can be found in the *SwitchBlade Switch Controller Quick Install Guide*.

Quick Install Guide updates can be downloaded from www.alliedtelesyn.co.nz/support/switchblade/.

Package Contents

The following items are included with each line card. Contact your sales representative if any items are damaged or missing.

- One SwitchBlade line card.
- One SwitchBlade Line Card Quick Install Guide.
- One Safety and Statutory Information booklet.
- One warranty card.

Related items that can be purchased separately:

- LineCAM (Content Addressable Memory) for enhanced L2/L3 forwarding-database table size, 192 k-entry modules.
- Blank faceplates for switch controller and line card bays (AT-SB4193).
- Approved Gigabit Interface Converters (GBICs). Contact your authorised Allied Telesyn distributor or reseller for more information.

Installing a Line Card



Line cards can be hot swapped. There is no need to power down the switch when installing or removing line cards. See the SwitchBlade Hardware Reference for detailed information on the operational characteristics of hot swapped interfaces.

Follow these steps to install a line card:

1. Read the safety information

The *SwitchBlade Safety and Statutory Information* booklet includes all relevant safety information. A copy of this booklet is supplied with each line card. A PDF version can be found on the CD-ROM that ships with every switch controller and every chassis, or can be downloaded from www.alliedtelesyn.co.nz/support/switchblade/.

2. Gather the tools and equipment you will need

To loosen or secure the line card's mounting screws you will need a Phillips #2 screwdriver.

3. Choose a bay for the line card

For the SwitchBlade 8 chassis (AT-SB4108):

Unless replacing an existing line card, choose the empty line card bay that is closest to the chassis's centre. This provides optimum cooling. Line card bays are bays 1 to 8.

For example, fill line card bays 4 and 5 first, followed by bays 3 and 6, then bays 2 and 7, and lastly bays 1 and 8. Bay numbers can be found on the chassis, above each bay.

For the SwitchBlade 4 chassis (AT-SB4104):

Unless replacing an existing line card, choose the empty line card bay that is closest to bottom of the chassis. This provides optimum cooling. Line card bays are bays 1 to 4.

For example, fill line card bay 4 first, and bay 1 last. Bay numbers can be found on the chassis, right of each bay.



Although line cards will operate in any combination of line card bays, filling the bays in the order described above provides optimum cooling.



Do not attempt to install a line card in a switch controller bay (bay A or B). Attempting to install a line card in a switch controller bay is likely to damage the line card and chassis.

4. Prepare the line card

In an antistatic environment, remove the line card from its packing material. Be sure to observe ESD precautions.



Do not attempt to install a line card without observing correct antistatic procedures. Failure to do so may damage the line card and chassis. If you are unsure what the correct procedures are, contact your authorised Allied Telesyn distributor or reseller.



An ESD socket is provided on the front panel of the SwitchBlade chassis. The socket is designed to be used in conjunction with an ESD wrist strap (see Figure 1 on page -5).

Figure 1: ESD socket on the SwitchBlade 8 chassis.

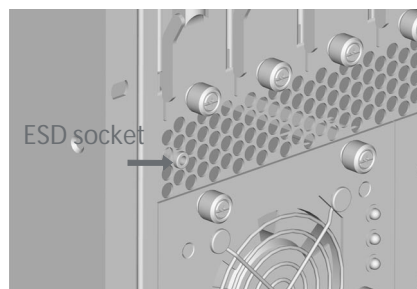
**5. Install CAM**

If you purchased a Content Addressable Memory (CAM) module, install it now by following the instructions in the *CAM Quick Install Guide*.

The *CAM Quick Install Guide* can be found on the SwitchBlade Documentation and Tools CD-ROM, or can be downloaded from www.alliedtelesyn.co.nz.

6. Remove the line card bay faceplate or existing line card**To remove a blank faceplate:**

Loosen the faceplate's two Phillips mounting screws until they disengage from the chassis, then remove the faceplate.



Keep the faceplate for future use. If you should remove a line card, replace the faceplate to prevent dust and debris from entering the chassis and to maintain proper airflow.



The switch may overheat or be damaged by dust and debris if bays are left uncovered.

To remove an existing line card:

Loosen the line card's two Phillips screws until they disengage from the chassis.

Move the line card ejector levers to the unlocked position (see Figure 2 on page -6).

Slide the line card out of the chassis, keeping the card in a straight alignment so it doesn't jam.

Figure 2: Ejector levers.

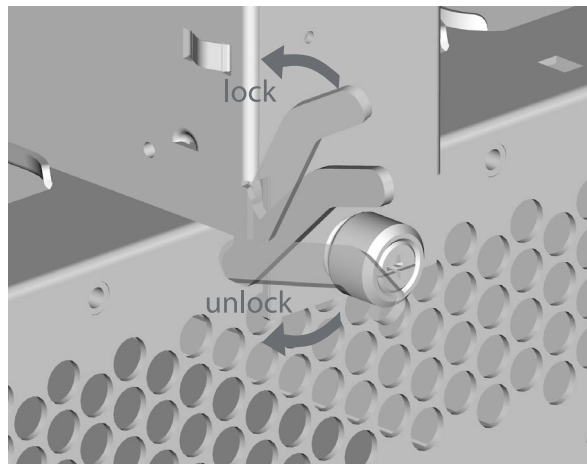

7. Insert the new line card

Make sure the line card's metal back-panel is aligned with the card guides (see Figure 3 on page -7).



Line cards are mounted vertically in the SwitchBlade 8 (AT-SB4108) chassis and horizontally in the SwitchBlade 4 (AT-SB4104) chassis.

With the ejector levers in the unlocked position (see Figure 2 on page -6), carefully slide the line card into the chassis.



When inserting a line card, take care to slide the card's metal back-panel along both guides at an equal rate. If a line card becomes tight, it must not be forced. Instead, gently withdraw the card and try again, taking extra care to keep the card aligned with the card guides. Forcing a misaligned or jammed line card is likely to damage the card or chassis.

The ejectors' locking mechanisms should align with their slots in the chassis (see Figure 4 on page -7).

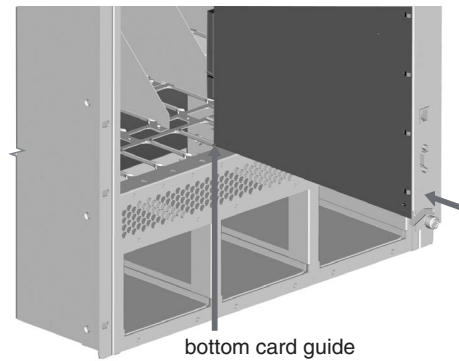
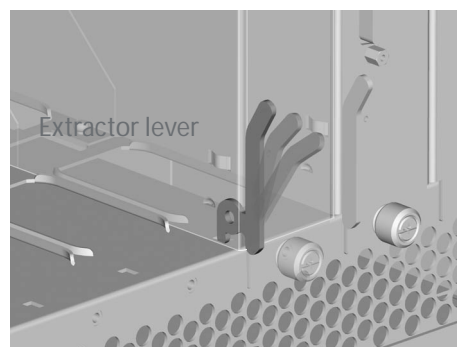
Figure 3: Card guides on the SwitchBlade 8 chassis.**Figure 4: Ejector lever and locking slot.****8. Secure the line card**

Move the ejector levers to the locked position and tighten the line card's two Phillips screws (see Figure 2 on page -6).

If the chassis is receiving power, one or more L/A LEDs will light amber when the line card is correctly installed. The LED(s) will remain lit until the card is configured.

9. For GBIC line cards, install the GBICs

Slide the GBICs into the card's GBIC slots. Press each GBIC firmly into place.



A range of GBICs have been tested and approved for use with the SwitchBlade, contact your authorised Allied Telesyn distributor or reseller for more information, or visit www.alliedtelesyn.co.nz.



RX and TX terminal locations on SC fibre GBIC ports are the reverse of RX and TX terminal locations on fixed SC fibre ports. When looking at an SC fibre GBIC from the front, the RX terminal is on the left and the TX terminal is on the right.

10. Connect the data cables

Make sure each cable connection is secure.

Line Card LEDs

The following LEDs will operate if the line card is installed in conjunction with a properly configured switch controller, at least one functional PSU, and a fan tray.

Table 1: LEDs on the AT-SB4411 8-port 10/100/1000BASE (RJ-45) Line Card .

LED	State	Function
L/A (Link activity)	Green	A 1000 Mbps link is open
	Flashing green	1000 Mbps activity is occurring
	Amber	A 10/100 Mbps auto-negotiating link is open. The L/A LED for port 1 briefly lights at switch power up or when the card is hot swapped in
	Flashing amber	10 or 100 Mbps activity is occurring
D/C (Duplex/collision)	Green	The port is operating at full-duplex
	Amber	The port is operating at half-duplex
	Flashing amber	Collisions are occurring

Table 2: LEDs on 8-port 1000BASE Fibre Line Cards¹.

LED	State	Function
L/A (Link activity)	Green	A 1000 Mbps link is open
	Flashing green	Link activity is occurring
	Amber	The L/A LED for port 1 briefly lights at switch power up or when the card is hot swapped in
D/C (Duplex/collision)	Green	The port is operating at full-duplex
	Amber	The port is operating at half-duplex
	Flashing	Collisions are occurring

1. Includes LEDs on the following models:
 AT-SB4451 8-port 1000BASE-SX (SC)
 AT-SB4452 8-port 1000BASE-SX (MT-RJ)
 AT-SB4461 8-port 1000BASE-LX (SC)
 AT-SB4462 8-port 1000BASE-LX (MT-RJ)

For the AT-SB4311 48-port line card, one LED is provided for each port. The default is for the LED to show link activity (L/A). To see Duplex/Collision activity (D/C), press and hold the LED Mode button (on the line card's front panel).

Table 3: LEDs on the AT-SB4311 48-port 10/100BASE (RJ-45) Line Card.

LED	State	Function
L/A (Default)	Green	A 100 Mbps link is open
	Flashing green	100 Mbps activity is occurring
	Amber	A 10 Mbps link is open. The L/A LEDs for ports 1 and 25 briefly light at switch power up or when the card is hot swapped in
	Flashing amber	10 Mbps activity is occurring
D/C (LED Mode button pressed)	Green	The port is operating at full-duplex
	Amber	The port is operating at half-duplex
	Flashing amber	Collisions are occurring

Table 4: LEDs on the AT-SB4352 32-port 100BASE-FX (MT-RJ) Line Card.

LED	State	Function
L/A (Link/Activity)	Green	A 100 Mbps link is open
	Flashing Green	100 Mbps activity is occurring
	Amber	The L/A LEDs for ports 1 and 17 briefly light at switch power up or when the card is hot swapped in
D/C (Duplex/Collision)	Green	The port is operating at full-duplex
	Amber	The port is operating at half-duplex
	Flashing Amber	Collisions are occurring

Table 5: LEDs on the AT-SB4441 8-port 1000BASE GBIC Line Card.

LED	State	Function
L/A (Link/Activity)	Green	A link is open
	Flashing Green	Activity is occurring
	Amber	The port is operating at half-duplex. The L/A LED for port 1 briefly lights at switch power up or when the card is hot swapped in
	Flashing Amber	Half-duplex activity is occurring
	Off	No link is present
GBIC Status	Green	A GBIC is installed and enabled
	Amber	A GBIC is installed but disabled
	Flashing Amber	A fault is occurring on the link
	Off	No GBIC is installed

More troubleshooting information can be found in the *SwitchBlade Hardware Reference*.

Where To Find More Information

Sources of further information:

- The Documentation and Tools CD-ROM bundled with every switch controller and every chassis, which contains the complete Documentation Set for your switch and its expansion options, as well as tools for managing the switch.
- The *SwitchBlade Safety and Statutory Information Booklet*, which provides safety and statutory information for the SwitchBlade and its accessories.
- The *SwitchBlade Hardware Reference*, which provides detailed information on the switch and its hardware features.
- The *SwitchBlade Software Reference*, which provides detailed information on configuring the switch and its software.
- The *SwitchBlade Power Supply Unit Quick Install Guide*, which outlines the procedure for installing AC and DC power supply units.
- The *SwitchBlade Switch Controller Quick Install Guide*, which outlines the procedure for installing switch controllers.
- The *SwitchBlade Chassis and Fan Tray Quick Install Guide*, which outlines the procedure for installing the chassis and its fan tray.
- The *SwitchBlade Bandwidth Expander Quick Install Guide*, which outlines the procedure for installing bandwidth expanders.
- The *CAM Quick Install Guide*, which outlines the procedure for installing Content Addressable Memory.
- www.alliedtelesyn.co.nz/support/switchblade/