

# Rapier Series Switch Hardware Reference



Rapier G6  
Rapier G6F  
Rapier 8/8  
Rapier 16F  
Rapier 16Fi  
Rapier 24  
Rapier 24i  
Rapier 48  
Rapier 48i

Rapier Switch Hardware Reference  
Document Number C613-03020-00 REV H.

Copyright © 1999-2005 Allied Telesyn International, Corp.  
19800 North Creek Parkway, Suite 200, Bothell, WA 98011, USA.

All rights reserved. No part of this publication may be reproduced without prior written permission from Allied Telesyn.

Allied Telesyn International, Corp. reserves the right to make changes in specifications and other information contained in this document without prior written notice. The information provided herein is subject to change without notice. In no event shall Allied Telesyn be liable for any incidental, special, indirect, or consequential damages whatsoever, including but not limited to lost profits, arising out of or related to this manual or the information contained herein, even if Allied Telesyn has been advised of, known, or should have known, the possibility of such damages.

All trademarks are the property of their respective owners.

# Contents

---

Models Covered By This Reference .....	4
Why You Should Read This Reference .....	5
Where To Find More Information .....	5
Hardware Description .....	6
Rapier Switch Models .....	8
Rapier G6 .....	8
Rapier G6F-LX/SC .....	8
Rapier G6F-SX/SC .....	9
Rapier G6F-SX/MT-RJ .....	9
Rapier 8/8MT .....	9
Rapier 8/8SC .....	10
Rapier 16F-FX/MT-RJ .....	10
Rapier 16Fi-FX/MT-RJ .....	10
Rapier 16F-FX/SC .....	11
Rapier 16Fi-FX/SC .....	11
Rapier 24 .....	12
Rapier 24i .....	13
Rapier 48 .....	13
Rapier 48i .....	13
Online Documentation .....	14
Accessing the CD-ROM and Online Documentation .....	14
AT-TFTP Server .....	14
Switch Start-up .....	15
To Log In .....	15
To access help files .....	16
Start-up Procedures .....	17
Switch Interfaces .....	19
RS-232 Terminal Port .....	19
Switch RJ-45 Ports .....	20
Redundant Power Supply .....	22
Switch Cables and Loopback Plugs .....	23
Terminal and Modem Cables .....	23
Loopback Plugs for Testing Switch Interfaces .....	25
Test Facility .....	25
10/100 Ethernet LAN Port Tests .....	27
Other Interface Tests .....	27
Troubleshooting .....	27
LEDs and What They Mean .....	27
Expansion Options .....	36
Uplink Modules .....	36
Network Service Modules .....	36
Port Interface Cards (PICs) .....	37
PCI Accelerator Cards (PACs) .....	38
Port, Connector, and Cable Combinations .....	41
Using Windows Terminal and Windows Hyperterminal .....	42
Restricted Procedures .....	44
Diagnostics .....	44
Installing a PAC .....	46
Replacing Boot EPROMs .....	52
Troubleshooting EPROM Installation .....	54
Contacting Us .....	54

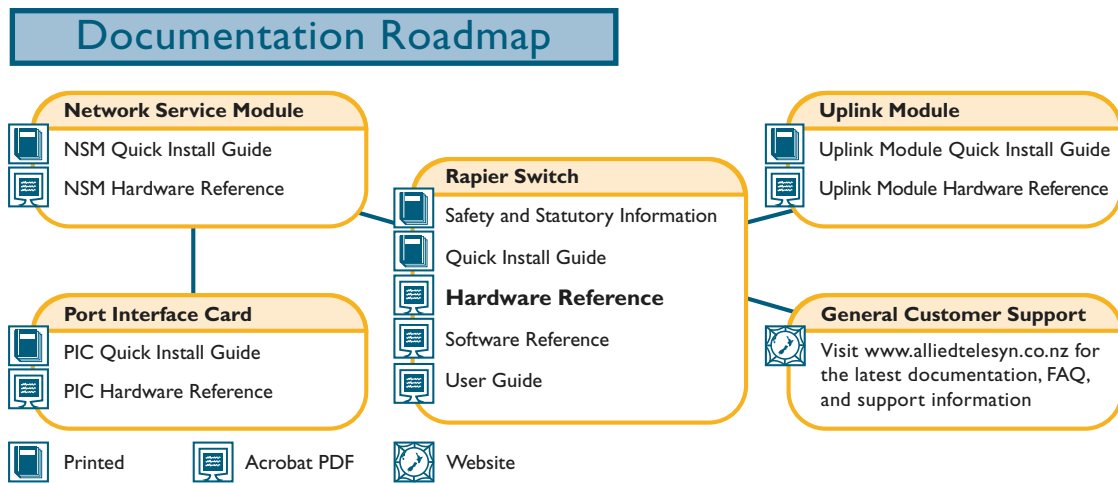

## Models Covered By This Reference

This Hardware Reference includes information on the following models:

- Rapier G6 6-port 100BASE-TX/1000BASE-T (RJ-45 connectors)
- Rapier G6F-LX/SC 6-port 1000BASE-LX (SC fibre connectors)
- Rapier G6F-SX/SC 6-port 1000BASE-SX (SC fibre connectors)
- Rapier G6F-SX/MT-RJ 6-port 1000BASE-SX (MT-RJ fibre connectors)
- Rapier 8/8MT 8-port 10BASE-T/100BASE-TX (RJ-45 connectors)  
plus 8-port 100BASE-FX (MT-RJ fibre connectors)
- Rapier 8/8SC 8-port 10BASE-T/100BASE-TX (RJ-45 connectors)  
plus 8-port 100BASE-FX (SC fibre connectors)
- Rapier 16F-FX/MT-RJ 16-port 100BASE-FX (MT-RJ fibre connectors)
- Rapier 16Fi-FX/MT-RJ 16-port 100BASE-FX (MT-RJ fibre connectors)
- Rapier 16F-FX/SC 16-port 100BASE-FX (SC fibre connectors)
- Rapier 16Fi-FX/SC 16-port 100BASE-FX (SC fibre connectors)
- Rapier 24 24-port 10BASE-T/100BASE-TX (RJ-45 connectors)
- Rapier 24i 24-port 10BASE-T/100BASE-TX (RJ-45 connectors)
- Rapier 48 48-port 10BASE-T/100BASE-TX (RJ-45 connectors)
- Rapier 48i 48-port 10BASE-T/100BASE-TX (RJ-45 connectors)

The latest Hardware Reference can be found at [www.alliedtelesyn.co.nz/support/rapier](http://www.alliedtelesyn.co.nz/support/rapier).

## Why You Should Read This Reference

---

This Reference has been developed to familiarise you with Rapier switches and their hardware features. The information found in this Reference will assist you with the process of installing and maintaining your Rapier Switch.

The Reference also introduces Uplink Module, Network Service Module (NSM) and Port Interface Card (PIC) expansion options. Detailed information on these options can be found in the *Uplink Module Hardware Reference*, the *Network Service Module Hardware Reference*, and the *Port Interface Card Hardware Reference*. These documents are included on the Rapier Switch Documentation and Tools CD-ROM bundled with your switch, or can be downloaded from [www.alliedtelesyn.co.nz/support/rapier](http://www.alliedtelesyn.co.nz/support/rapier).



---

*Keep this Reference (or its CD-ROM) in a safe place, you will need it if you purchase switch expansion options in the future.*

---



---

*This Reference does not cover software configuration or software installation procedures. For information on software, refer to the *Rapier Switch Software Reference*.*

---

## Where To Find More Information

---

The Documentation and Tools CD-ROM bundled with each Rapier Switch contains the complete Document Set for Rapier Switches and their expansion options, as well as tools for managing the switch. This includes:

- The *Rapier Switch Safety Booklet*, which provides safety and statutory information.
- The *Rapier Switch Quick Install Guide*, which outlines the procedure for installing switch units; and this *Rapier Switch Hardware Reference*.
- The *Rapier Switch Software Reference*, which provides detailed information on configuring the switch and its software.
- The *Network Service Module Quick Install Guide*, which outlines the procedure for installing an NSM; and the *Network Service Module Hardware Reference*, which provides detailed information on NSMs.
- The *Port Interface Card Quick Install Guide*, which outlines the procedure for installing PICs; and the *Port Interface Card Hardware Reference*, which provides detailed information on PICs.
- The *Uplink Module Quick Install Guide*, which outlines the procedure for installing an Uplink Module; and the *Uplink Module Hardware Reference*, which provides detailed information on Uplink Modules.
- AT-TFTP Server for Windows, for downloading software releases.
- Adobe Acrobat Reader, for viewing online documentation.
- Microsoft Internet Explorer.

These documents can also be downloaded from the Rapier Switch Support Site at [www.alliedtelesyn.co.nz/support/rapier](http://www.alliedtelesyn.co.nz/support/rapier).

## Hardware Description

---

This section provides an overview of the hardware features for the Rapier Switch series. Hardware descriptions for Uplink Modules, NSMs, and PICs can be found in their respective hardware references. These references can be found on the CD-ROM bundled with your switch, or can be downloaded from [www.alliedtelesyn.co.nz/support/rapier](http://www.alliedtelesyn.co.nz/support/rapier).

### Switch Overview

Rapier Switches combine wire-speed Layer 2 and 3 switching with full multiprotocol routing capabilities to deliver low-latency high-bandwidth traffic capabilities to the desktop. Ethernet, fast Ethernet and gigabit Ethernet connectivity with both copper and fibre optic interfaces make the Rapier Series a versatile and powerful switching solution.

### Dimensions

- Height = 66 mm (plus 5.5 mm if the rubber feet are used)
- Width = 440 mm (excluding rack-mounting brackets)
- Depth = 360 mm (including NSM face-plate)
- Weight = Not more than 7 kg, depending on model (excluding NSMs, PICs, and power cord)

### Mounting System

- 1.5U rack mounting

### Environmental Conditions

- Operating temperature range: 0 to 40° C (32 to 104° F)
- Storage temperature range: -25 to 70° C (-13 to 158° F)
- Relative humidity range: 5 to 95% non-condensing

### Regulatory Standards

- EMC: CISPR22 class A, FCC class A, and VCCI class I
- Immunity testing to EN50082 levels 2 (ESD), 3 (susceptibility), 4 (fast transients), 5 (power surge), and 6 (RF immunity)
- Safety: UL1950, CSA22.2, EN60950

### LEDs

- Ethernet port and System status LEDs
- For a complete list of LEDs and their functions, see “Fault Indicators and What They Mean” on page 24.

## Power Supply Unit

### AC models

- Universal 110/240 VAC 50/60 Hz input
- Redundant DC Power connection

### DC models

- 48 VDC (39-60 VDC is acceptable)
- 4 Amps
- Positive or negative earthing (grounding).

## Switching Core

Rapier 8/8MT, 8/8SC, 16F-FX/MT, 16F-FX/SC, 24, 48

- Application-Specific Integrated Circuit (ASIC) switch chip
- Non-blocking L2 and L3 IP Switching

Rapier G6, G6F/LX, G6F/SX, G6F/MT

- Gigabit ASIC switch chip
- Non-blocking L2 and L3 IP Switching

Rapier 16Fi-FX/MT, 16Fi-FX/SC, 24*i*, 48*i*

- Advanced ASIC switch chip
- Non-blocking L2 and L3 IP Switching

## Processing Core

- 200 MHz RISC Processor (250 MHz for Rapier 24*i* models with revision N or higher PCBs)
- 32 MBytes Synchronous DRAM
- 6 MBytes flash memory (16 MBytes for Rapier *i* models)
- 128 KBytes Non-volatile Storage (battery backed SRAM)

## Asynchronous Serial Port

- Up to 115 kbps
- Standard DB9 female RS-232 connector
- Hardware-flow control

## PCI Accelerator Card (PAC) Slot

(Not included on the Rapier 48, 48*i*, G6, or G6F.)

- For an optional 32-bit PCI based hardware Encryption and or Compression Card

## Uplink Module Bays

- 2 very high performance bays
- Support for gigabit Ethernet uplink modules (Rapier G6 and Rapier *i* switches support 10BASE-T/100BASE-TX in addition to 1000BASE-T)

### Network Service Module (NSM) Bay

(Not included on the Rapier 48, 48i, G6, G6F/SX, or G6F/LX.)

- Support for one 32-bit PCI based WAN module
- Modules will include hot swap capability with future software releases

## Rapier Switch Models

This section provides hardware descriptions for individual switch models.

### Rapier G6

(Figure 1 on page 8)

- 6-port 100BASE-TX/1000BASE-T (RJ-45 connectors)
- Two 10/100/1000BASE uplink bays
- Layer 3 Managed Switch

Figure 1: Front panel of the Rapier G6.

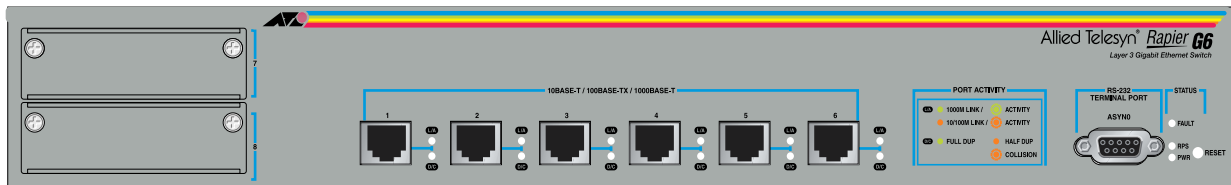

### Rapier G6F-LX/SC

(Figure 2 on page 8)

- 6-port 1000BASE-LX (SC fibre connectors)
- Two 10/100/1000BASE uplink bays
- Layer 3 Managed Switch

Figure 2: Front panel of the Rapier G6F/LX.

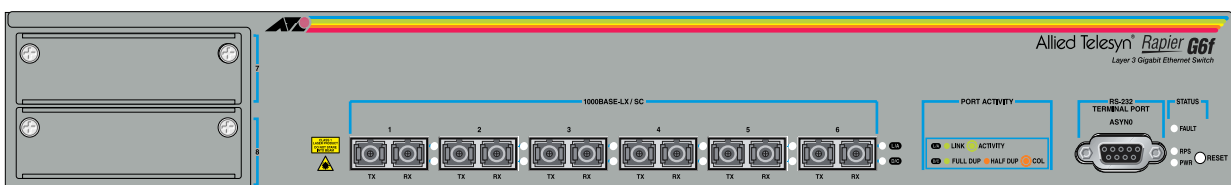

## Rapier G6F-SX/SC

(Figure 3 on page 9)

- 6-port 1000BASE-SX (SC fibre connectors)
- Two 10/100/1000BASE uplink bays
- Layer 3 Managed Switch

Figure 3: Front panel of the Rapier G6F/SX.

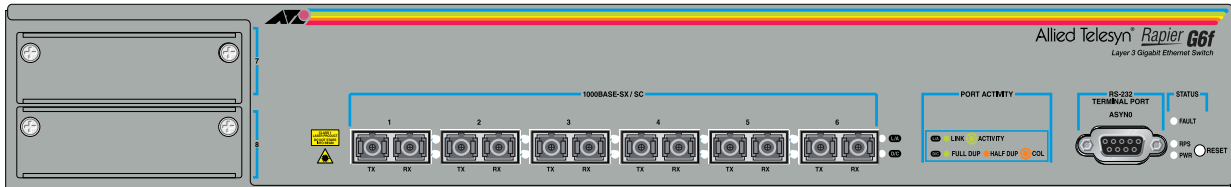

## Rapier G6F-SX/MT-RJ

(Figure 4 on page 9)

- 6-port 1000BASE-SX (MT-RJ fibre connectors)
- Two 10/100/1000BASE uplink bays
- Layer 3 Managed Switch

Figure 4: Front panel of the Rapier G6F/MT

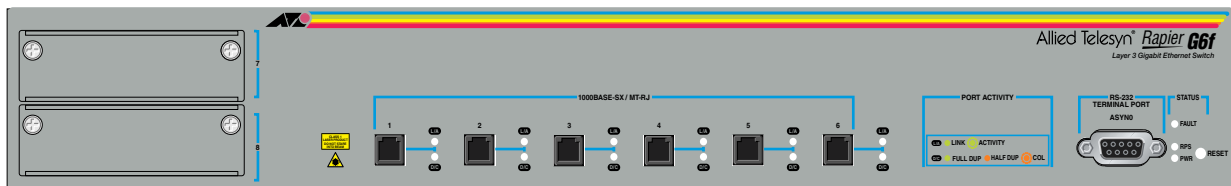

## Rapier 8/8MT

(Figure 5 on page 9)

- 8-port 10BASE-T/100BASE-TX (RJ-45 connectors)
- 8-port 100BASE-FX (MT-RJ fibre connectors)
- Two 1000BASE uplink bays
- One Network Service Module bay (with support for various WAN interface cards)
- One PCI Accelerator Card (PAC) Slot
- Layer 3 Managed Switch

Figure 5: Font panel of the Rapier 8/8MT.

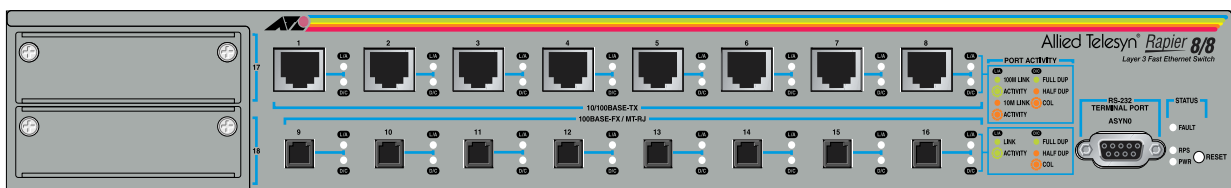

## Rapier 8/8SC

(Figure 6 on page 10)

- 8-port 10BASE-T/100BASE-TX (RJ-45 connectors)
- 8-port 100BASE-FX (SC fibre connectors)
- Two 1000BASE uplink bays
- One Network Service Module bay (with support for various WAN interface cards)
- One PCI Accelerator Card (PAC) Slot
- Layer 3 Managed Switch

Figure 6: Front panel of the Rapier 8/8SC.

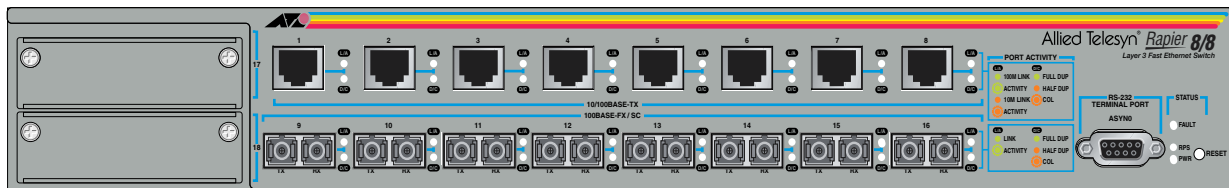

## Rapier 16F-FX/MT-RJ

(Figure 7 on page 10)

- 16-port 100BASE-FX (MT-RJ fibre connectors)
- Two 1000BASE uplink bays
- One Network Service Module bay (with support for various WAN interface cards)
- One PCI Accelerator Card (PAC) Slot
- Layer 3 Managed Switch

Figure 7 Front panel of the Rapier16F-FX/MT.

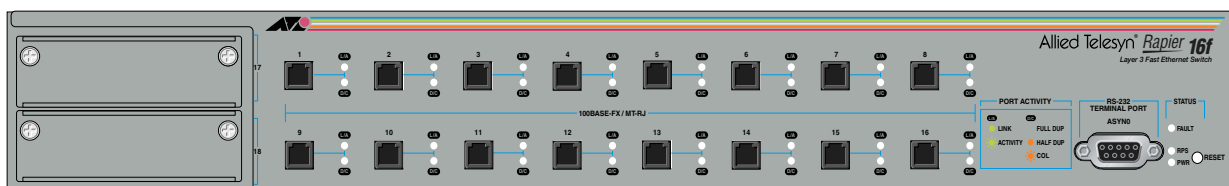

## Rapier 16Fi-FX/MT-RJ

(Figure 8 on page 11)

- 16-port 100BASE-FX (MT-RJ fibre connectors)
- Two 1000BASE uplink bays
- One Network Service Module bay (with support for various WAN interface cards)
- One PCI Accelerator Card (PAC) Slot
- Auto-negotiating Layer 3 Managed Switch
- Enhanced 5615 switching core

Figure 8: Front panel of the Rapier16Fi-FX/MT.

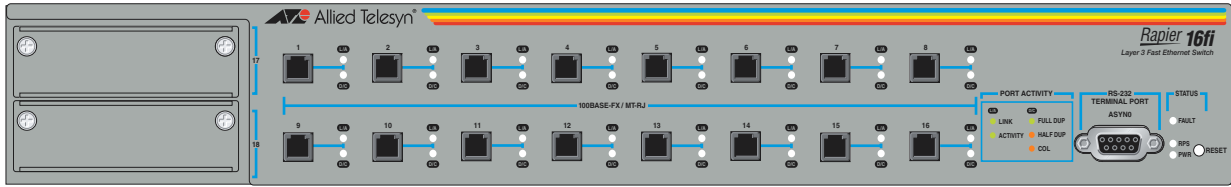

### Rapier 16F-FX/SC

(Figure 9 on page 11)

- 16-port 100BASE-FX (SC fibre connectors)
- Two 1000BASE uplink bays
- One Network Service Module bay (with support for various WAN interface cards)
- One PCI Accelerator Card (PAC) Slot
- Layer 3 Managed Switch

Figure 9: Front panel of the Rapier16F-FX/SC.

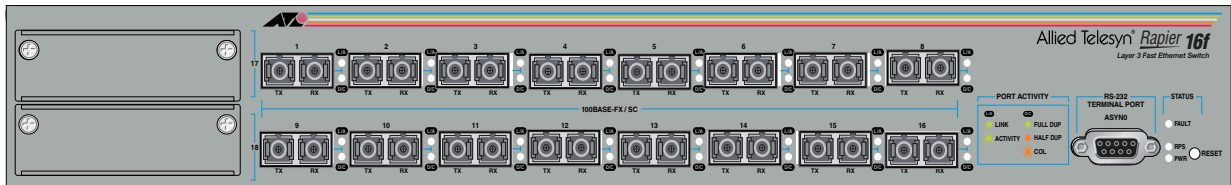

### Rapier 16Fi-FX/SC

(Figure 10 on page 11)

- 16-port 100BASE-FX (SC fibre connectors)
- Two 1000BASE uplink bays
- One Network Service Module bay (with support for various WAN interface cards)
- One PCI Accelerator Card (PAC) Slot
- Auto-negotiating Layer 3 Managed Switch
- Enhanced 5615 switching core

Figure 10: Front panel of the Rapier 16Fi-FX/SC

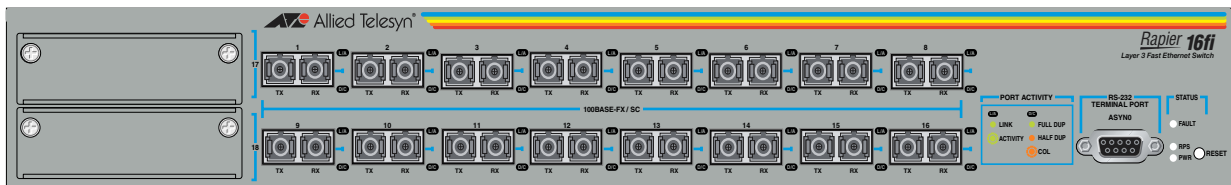



## Rapier 24i

(Figure 12 on page 13)

- 24-port 10BASE-T/100BASE-TX (RJ-45 connectors)
- Two 10/100/1000BASE uplink bays
- One Network Service Module bay (with support for various WAN interface cards)
- One PCI Accelerator Card (PAC) Slot
- Auto-negotiating Layer 3 Managed Switch
- Enhanced 5615 switching core

Figure 12: Front panel of the Rapier 24i.

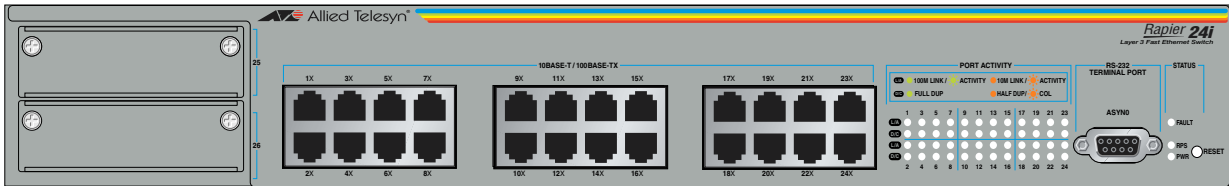

## Rapier 48

(Figure 13 on page 13)

- 48-port 10BASE-T/100BASE-TX (RJ-45 connectors)
- Two 1000BASE uplink bays
- Auto-negotiating Layer 3 Managed Switch

Figure 13: Front panel of the Rapier 48.

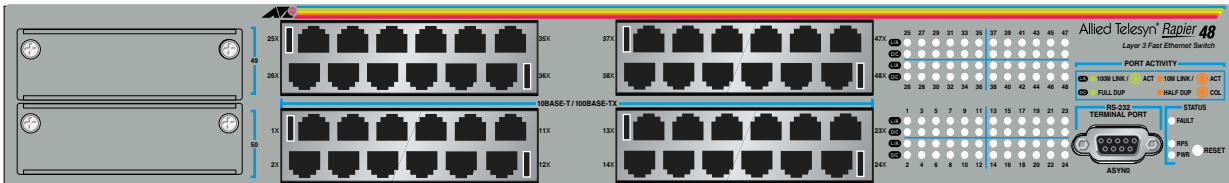

## Rapier 48i

(Figure 14 on page 13)

- 48-port 10BASE-T/100BASE-TX (RJ-45 connectors)
- Two 10/100/1000BASE uplink bays
- Auto-negotiating Layer 3 Managed Switch
- Enhanced 5615 switching core

Figure 14: Front panel of the Rapier 48i.

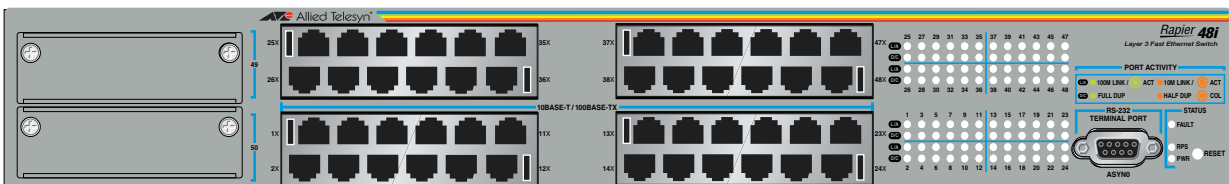

## Online Documentation

---

This section provides a step-by-step guide to accessing online documentation. Adobe Acrobat Reader must be installed to view online documentation.

### Accessing the CD-ROM and Online Documentation

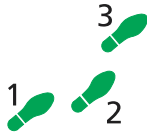

Follow these steps to access the CD-ROM and online documentation:

**1. Insert the Rapier Documentation and Tools CD-ROM in the CD-ROM drive.**

**2. If the Welcome screen does not appear.**

Select "Run" from the Start Menu (Windows 95, 98, 2000 or NT 4.0).

Type d:\start.exe (where d: is the CD-ROM drive letter) and click OK.

**3. To view a document.**

Click on the document title.

**4. To navigate around PDF documents.**

Use the toolbar buttons, keyboard shortcuts, or commands from the Document menu to page through the document.

Click on a bookmark, thumbnail or hypertext link to jump to a specific section or topic.

Use the Search command to search for keywords or phrases.

For more information about using the Adobe Acrobat Reader, select "Reader Guide" from the Help menu.

**5. To install any of the tools included on the CD-ROM.**

Click on a link in the Welcome screen.

## AT-TFTP Server

---

This section provides information on how to access and use AT-TFTP Server. AT-TFTP Server can be used to transfer configuration files as well as to download software patches and releases.

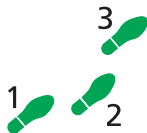

To use AT-TFTP Server, follow these steps:

**1. If AT-TFTP Server has not yet been installed.**

Install it now from the Rapier Switch Documentation and Tools CD-ROM.

Choose AT-TFTP Server from the Start > Programs > Allied Telesyn > AT-TFTP Server menu.

**2. To set preferences for the AT-TFTP Server.**

Select "Options" from the File menu to display the "Set Preferences" dialog box.

The "Default file transfer directory" field specifies the directory that AT-TFTP Server will read from or write to for file requests that do not include a directory specification.

To prevent unauthorised access to private directories, enter a path name in the "Restrict to directory" field. AT-TFTP Server will use only the specified directory, even if file requests contain references to other directories.

Select "Read only" to prevent files being written to the PC. To use the PC to archive scripts created using the switch's CREATE CONFIG command, select "Read Write".

Make any required changes and click "OK".

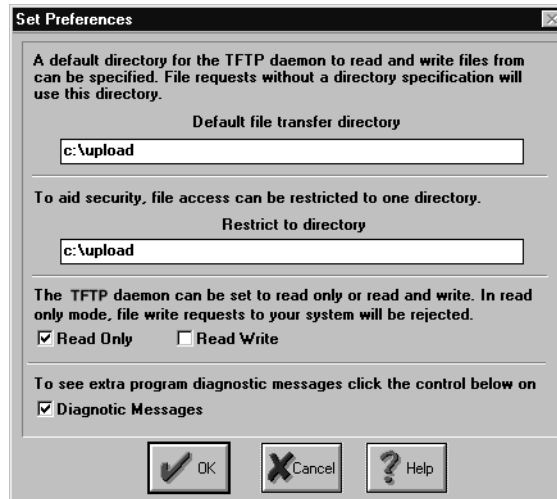

### 3. To load a file from AT-TFTP Server to the Switch.

On a terminal connected to the switch, type the command:

```
LOAD METHOD=TFTP FILE=filename SERVER=ipadd DEST=FLASH
```

where *filename* is the name of the file to download and *ipadd* is the IP address of the PC running AT-TFTP Server.

### 4. To save a TFTP Server log.

Select "Save As" from the File menu.

TFTP requests are logged to the AT-TFTP Server main window.

## Switch Start-up

This section outlines the log in and start-up procedures for your switch. Although the switch will perform basic switching operations without being configured, you will need to go through these log in and start-up procedures if you wish to configure the switch and access its full layer 3 switching capabilities.

### To Log In

Using the supplied RS-232 DB9 straight-through cable, connect your terminal or PC to the RS-232 Terminal Port on the switch's front panel.

Set the communication parameters on your terminal or terminal emulation program to:

- Baud rate: 9600
- Data bits: 8
- Parity: None
- Stop bits: 1
- Flow control: Hardware

See “Using Windows Terminal and Windows Hyperterminal” on page 37 for more information on configuring emulation software.

After the switch has booted, the log in prompt appears. If the log in prompt does not appear, press [Enter] two or three times.

When the switch boots for the first time it automatically creates an account with manager privileges. The account has the log in name “manager” and the password is “friend”.

At the log in prompt, enter the log in name and password.

```
Log in: manager
```

```
Password: friend
```

The switch’s command prompt appears and you can now configure the switch using the command line interface.



---

*Change the password as soon as possible. Leaving the manager account with the default password is a serious security risk. Make sure that you remember the new password as there is no way to retrieve it if it is lost.*

---

Use the following command to change the account password:

```
set password
```

See the *Rapier Switch Software Reference* for more information on configuring the switch.

## To access help files

Before help is used for the first time, the help files must be defined.

To define the files, enter:

```
set help=help-filename
```

where *help-filename* is the name of a help file stored in flash.

To see a list of files stored in flash, enter:

```
show file
```

Help files have an HLP extension.

To display a list of help topics, enter:

```
help
```

To display help on a specific topic, enter:

```
help topic
```

Alternatively, type a question mark (?) at the end of a partially completed command to see a list of valid options.

## Start-up Procedures

When the switch starts up following either a power cycle or an operator-initiated reboot (using the Reset button or RESTART command), a series of start-up messages is sent to the RS-232 Terminal Port (Figure 15 on page 17).

**Figure 15: Switch start-up messages.**

```
INFO: Self tests beginning.
INFO: RAM test beginning.
PASS: RAM test, 32768k bytes found.
INFO: BBR tests beginning.
PASS: BBR test, 128k bytes found.
INFO: Self tests complete
INFO: Downloading switch software.
Force EPROM download (Y) ?
INFO: Initial download succeeded
INFO: Executing configuration script <boot.cfg>
INFO: Switch startup complete

Manager >
```

After the self tests are complete, the manager is given the option of forcing a mandatory boot from the EPROM release. The message:

```
Force EPROM download (Y) ?
```

is displayed on the terminal connected to the RS-232 Terminal Port and the switch pauses. If a key is not pressed within a few seconds, the start-up process will continue and all steps in the sequence will be executed. Pressing selected keys on the terminal immediately after the “Force EPROM download” message is displayed will change the switch start-up process (Table 1 on page 17).

**Table 1: Switch start-up sequence keystrokes.**

Pressing key...	Forces the switch to...
[Y]	Load the EPROM release, with no patch.
[S]	Start with the default configuration. Any boot script is ignored.
[Ctrl/D]	Enter diagnostics mode.

During the start-up process the switch will generate four different types of messages. All messages are preceded by one of the words INFO, PASS, FAIL, or ERROR. The significance of these words is shown in Table 2 on page 17.

**Table 2: Switch start-up message classes.**

Message	Meaning
INFO	An action will be taken by the system.
PASS	A test has been completed successfully.
ERROR	An error message that a test has failed, but the system will continue to operate.
FAIL	An error message that a fatal error condition has caused the system to halt in an unrecoverable fashion.

The possible messages and their meanings are:

INFO: Self tests beginning.

The code loader tests are about to begin.

INFO: RAM test beginning.

The RAM tests are about to begin.

PASS: RAM test, 32768k bytes found.

The RAM test passed, and the indicated amount of memory was found and will be used in the switch.

ERROR: RAM test 5. Error address = 00345678.

A RAM test failed, at the given address. In the example, it was the fifth test run. The RAM test repeats until it passes, so a number of messages like this may appear. This fault means that the memory system is faulty. If the fault continues, contact your Authorised Allied Telesyn distributor or reseller immediately.

INFO: BBR tests beginning.

The BBR battery tests are about to begin.

PASS: BBR test. Battery OK.

The BBR battery tests passed.

ERROR: BBR Battery low.

The BBR battery test failed, indicating that the battery is running low. The BBR battery will need to be replaced. Contact your Authorised Allied Telesyn distributor or reseller.

PASS: BBR test, 256k bytes found.

The BBR size/location test passed, with the indicated amount of BBR found.

FAIL: BBR test. Error address = 12345678.

The BBR size/location test failed at the given location. The test at this location failed, indicating the end of memory, but a valid location was discovered in the 255 long words following this location. The BBR system will need to be replaced. Contact your Authorised Allied Telesyn distributor or reseller.

FAIL: BBR test, only 16k bytes found.

The BBR size/location test completed, but only the displayed amount of memory was found. This amount is less than the minimum required to run the switch software.

INFO: Self tests complete.

The start-up tests have finished.

INFO: Downloading switch software.

The process of downloading the switch software and vector table from ROM is about to begin.

ERROR: Code load retried.

FAIL: Code load failed.

The load of the code from ROM to RAM failed. The load is retried a number of times. Each time a failure occurs, the ERROR message is displayed. If the maximum number of attempts is reached, the FAIL message is displayed.

INFO: Initial download succeeded.

The start-up tests and download are complete, and the switch software is about to be started. If the default install is a compressed release, the release will now be decompressed. This may take a few seconds.

INFO: Downloading compressed release. This may take up to 1 minute...

```
INFO: Loading software into memory. This may take up to 1
      minute...
```

The main switch software is about to be loaded into RAM. If the release is a compressed release, the release will be decompressed.

```
INFO: Executing configuration script <script-name>
```

The configuration commands stored in <script-name> are being executed. If an error is found in the script, one or more ERROR messages will be displayed.

```
INFO: Switch startup complete.
```

The start-up process is complete and the switch will now perform basic switching operations. Further configuration will be necessary if you wish to access the switch's full layer 3 switching capabilities. See the Rapier Switch Software Reference for detailed information on configuring the switch.

## Switch Interfaces

This section provides pin assignments for the switch's RS-232 Terminal Port and RJ-45 ports, and the Redundant Power Supply (RPS) connector.

If you have installed a Port Interface Card (PIC), pin assignments for these can be found in the *Port Interface Card Hardware Reference* (which is included on the Documentation and Tools CD-ROM bundled with your switch, or can be downloaded from [www.alliedtelesyn.co.nz/support/rapier](http://www.alliedtelesyn.co.nz/support/rapier)).

### RS-232 Terminal Port

The RS-232 Terminal Port is used to connect the switch to a management device. For management purposes the switch's software can be accessed from a terminal, a PC running terminal emulation software, or from a remote location via a modem connection. You can also use the RS-232 Terminal Port to establish a network connection from a remote site using SLIP and a modem.

The switch's RS-232 Terminal Port has a DCE female socket. This allows the use of a straight-through cable when connecting the switch to a terminal or PC. Output from the SHOW ASYN command will, however, still have a DTE perspective. The internal DTE pin roles are listed in Table 3 on page 20.

See Terminal and Modem Cables on page 20 for more information on connection options for the RS-232 Terminal Port.

**Figure 16: RS-232 Terminal Port Pin Numbers.**

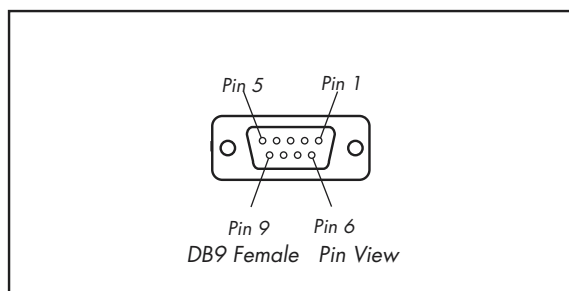

**Table 3: Internal DTE pin roles.**

Pin	Role
2	TXD
3	RXD
4	CD
5	GND
6	DTR
7	CTS
8	RTS

## Switch RJ-45 Ports



*Caution. Do not plug a phone jack into any RJ-45 port. Doing so could damage the switch. Use only twisted pair cables with RJ-45 connectors.*

For 10BASE-T/100BASE-TX connections, a twisted pair cable must be used. Each pair is identified by two different colours. For example, one wire might be red, and the other red with a white stripe. An RJ-45 connector must be fitted to both ends of the cable. Figure 17 on page 20 illustrates the pin layout for RJ-45 connectors.

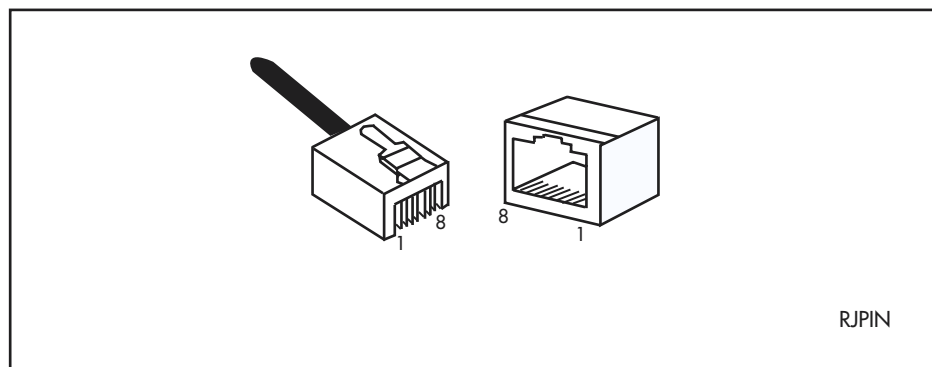
**Figure 17: RJ-45 Pin layout.**

With 10BASE-T/100BASE-TX cables, pins 1 and 2 are used for transmitting data, while pins 3 and 6 are used for receiving data. Table 4 on page 20 lists the RJ-45 Pin assignments.

**Table 4: RJ-45 Pin assignments.**

Pin Number	Assignment <sup>1</sup>
1	TX+
2	TX-
3	RX+
6	RX-

1. The "+" and "-" signs represent the polarity of the wires that make up each wire pair.

If a twisted pair cable is to join two ports and only one of the ports has an internal crossover, the two pairs must be straight through, as listed in Table 5 on page 21.

**Table 5: RJ-45 Pin assignments, straight through cable.**

End 1	End 2
1 (TX+)	1 (TX+)
2 (TX-)	2 (TX-)
3 (RX+)	3 (RX+)
6 (RX-)	6 (RX-)

If a twisted pair cable is used to join two ports and either both ports are labelled with an "X" or neither port is labelled with an "X", a crossover must be included in the wiring. Table 6 on page 21 lists the RJ-45 crossover wiring pin assignments.

**Table 6: RJ-45 Pin assignments, crossover cable.**

End 1	End 2
1 (TX+)	3 (TX+)
2 (TX-)	6 (TX-)
3 (RX+)	1 (RX+)
6 (RX-)	2 (RX-)

For 1000BASE-T RJ-45 cables, all four pairs are used and the cable is wired in a straight-through configuration. Table 7 on page 21 lists the pin assignments.

**Table 7: Pin assignments, 1000BASE-T RJ-45 cable .**

End 1	End 2
1 Pair 1+	1 Pair 1+
2 Pair 1-	2 Pair 1-
3 Pair 2+	3 Pair 2+
6 Pair 2-	6 Pair 2-
4 Pair 3+	4 Pair 3+
5 Pair 3-	5 Pair 3-
7 Pair 4+	7 Pair 4+
8 Pair 4-	8 Pair 4-

## Redundant Power Supply

AC models of Rapier Switches have a Redundant Power Supply (RPS) connector on their rear panel. Table 8 on page 22 lists the connector's pin numbers and pin functions.

**Table 8: RPS Connector Pin Numbers and Functions.**

Pin Number	Function
1	+12 VDC
2	Remote Sense (RS) +5 VDC
3	Remote Sense (RS) Ground
4	Remote Sense (RS) +3.3 VDC
5	Redundant Power Supply (RPS) Present
6	Ground (+3.3 VDC Return)
7	Ground (+5 VDC Return)
8	+5 VDC
9	Ground (+12 VDC Return)
10	+3.3 VDC
11	Ground (+3.3 VDC Return)
12	+3.3 VDC
13	Ground (+3.3 VDC Return)
14	+3.3 VDC
15	+5 VDC
16	Ground (+5 VDC Return)

Table 9 on page 22 illustrates the connector's pin layout.

**Table 9: RPS Connector's Pin Layout.**

16	15	14	13	12	11	10	9
8	7	6	5	4	3	2	1

Pin 16 is at the connector's top left, while pin 1 is at its lower right.

# Switch Cables and Loopback Plugs

This section describes how to make cables for connecting the switch's interfaces to networks, terminals, and printers. How to make loopback plugs for testing switch interfaces is also described.

Descriptions of cables and loopback plugs for PIC interfaces can be found in the *Port Interface Card Hardware Reference*.

## Terminal and Modem Cables

Figure 18 on page 23 shows how to wire cables to connect a standard VT100 compatible terminal, or a modem, to the switch's RS-232 Terminal Port.

**Figure 18: Pin wiring diagram for a standard DB9 male to female terminal cable.**

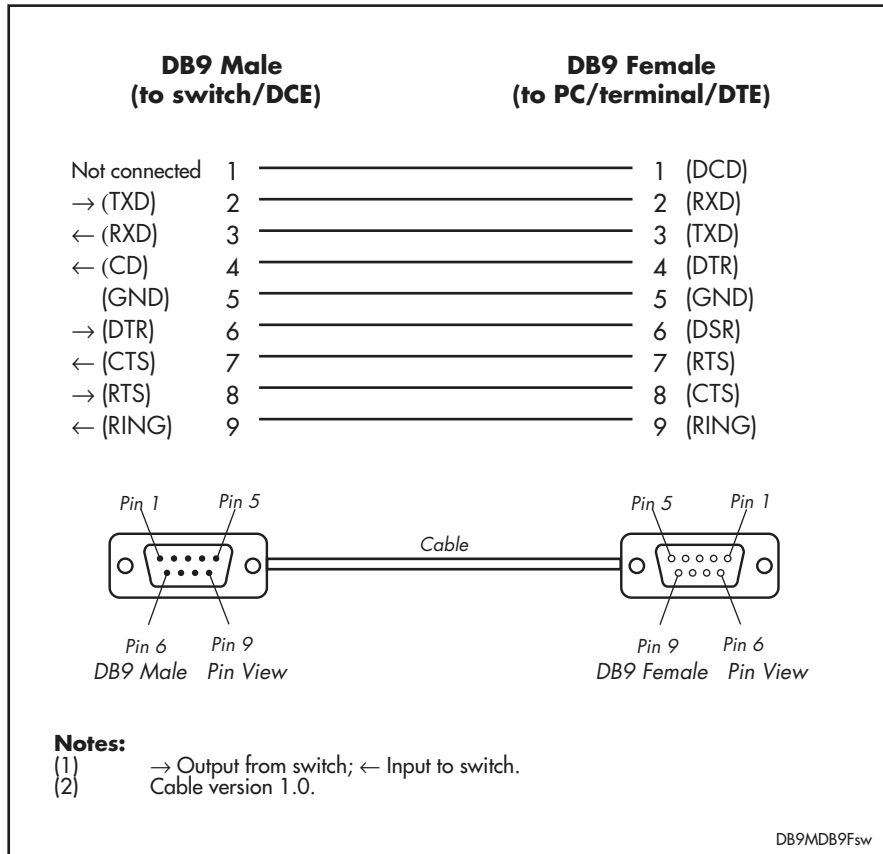

**Figure 19: Pin wiring diagram for a DCE RS-232 Terminal Port (DB9 female connector) male to male modem cable.**

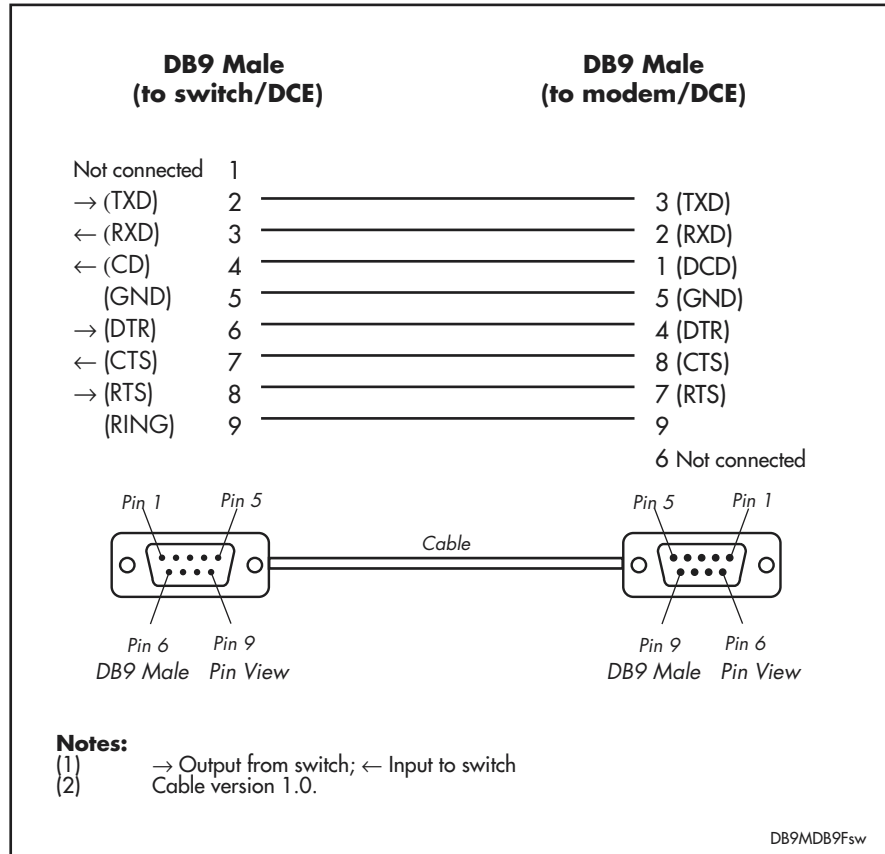

The switch’s RS-232 Terminal Port has a DCE female socket. This allows the use of a straight-through cable when connecting the switch to a terminal or PC. Output from the SHOW ASYN command will, however, still have a DTE perspective. The internal DTE pin roles are listed in Table 10 on page 24.

**Table 10: Internal DTE pin roles.**

Pin	Role
2	TXD
3	RXD
4	CD
5	GND
6	DTR
7	CTS
8	RTS

## Loopback Plugs for Testing Switch Interfaces

Loopback plugs are used in conjunction with the Test Facility software to test the physical interfaces on the switch and some PICs (see the “Test Facility” section beginning on page 22 of this Reference, and the *Test Facility* chapter of the *Rapier Switch Software Reference*). The purpose of a loopback plug is to connect the output pins on the interface to the input pins so that any data transmitted over the interface is looped back and received at the same interface.



*Gigabit copper interfaces cannot be looped back. Loopback plugs can only be used in conjunction with 10/100 Ethernet interfaces.*

On interfaces with control signals, these are also looped back. The data received on the interface is compared with the data transmitted to determine whether or not the interface is functioning correctly. In order to produce a comprehensive test report for the interface being tested, most tests performed by the Test Facility require a loopback plug to be inserted.

Some interfaces (e.g. synchronous ports) require a specially built external testing device (available from your Authorised Allied Telesyn distributor or reseller) to be used in conjunction with the Test Facility.

**Figure 20: Ethernet twisted pair (TP) loopback plug.**

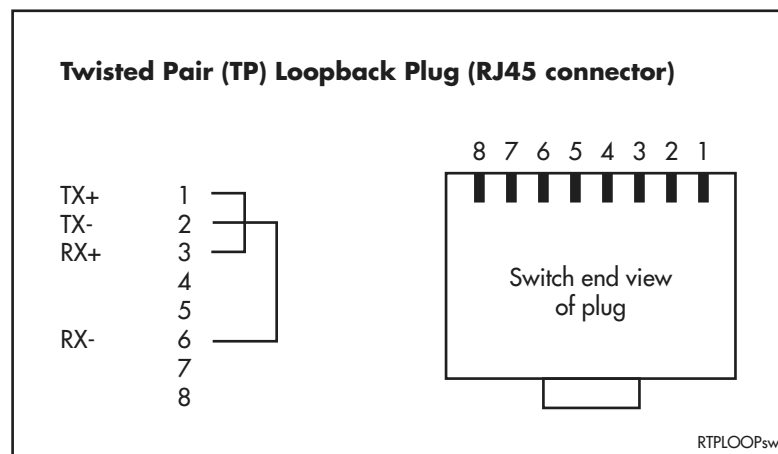

## Test Facility

This section introduces the Test Facility. The Test Facility is built into all Rapier Switch software. For detailed information on operating the Test Facility, see the *Test Facility* chapter of the *Rapier Switch Software Reference*.

The Test Facility is designed to test the switch’s physical interfaces. Testing should not be performed while the switch is operational as the presence of a loopback plug may cause feedback of network traffic. Also, any interfaces being tested are dedicated to the Test Facility. The Test Facility can be thought of as a specialised interface module like PPP or Frame Relay.



*The Test Facility will not test Ethernet interfaces on AT-AR026 PICs.*

Rapier Switches and their expansion options support a wide range of interface types, including Ethernet, asynchronous, synchronous, Basic Rate ISDN and Primary Rate ISDN. Each interface type (except Ethernet interfaces on the AT-AR026) can be tested independently using the Test Facility software. The following examples show how to test specific interfaces.

Test results are displayed with the command:

```
SHOW TEST
```

This produces a display similar that shown in Figure 21 on page 26.

**Figure 21: Example output from the SHOW TEST command.**

Board	ID	Bay	Board Name	Rev	Serial number	
Base	108		AT-RP24 Rapier 24	M1-1	6845425	
Uplink	88	1	AT-A35SX/SC-00	P1-0	14269019	
Interface	State	Result	Type	Duration (minutes)	Details Data( %OK )	Control
port1	no test	-	-	-	-	-
port2	no test	-	-	-	-	-
port3	no test	-	-	-	-	-
port4	no test	-	-	-	-	-
port5	no test	-	-	-	-	-
port6	no test	-	-	-	-	-
port7	no test	-	-	-	-	-
port8	no test	-	-	-	-	-
port9	no test	-	-	-	-	-
port10	no test	-	-	-	-	-
port11	no test	-	-	-	-	-
port12	no test	-	-	-	-	-
port13	no test	-	-	-	-	-
port14	no test	-	-	-	-	-
port15	no test	-	-	-	-	-
port16	no test	-	-	-	-	-
port17	no test	-	-	-	-	-
port18	no test	-	-	-	-	-
port19	no test	-	-	-	-	-
port20	no test	-	-	-	-	-
port21	no test	-	-	-	-	-
port22	no test	-	-	-	-	-
port23	no test	-	-	-	-	-
port24	no test	-	-	-	-	-
port26	no test	-	-	-	-	-
asyn0	no test	-	-	-	-	-

## 10/100 Ethernet LAN Port Tests

A loopback plug is required to run the first part of the Ethernet LAN test. See “Loopback Plugs for Testing Switch Interfaces” on page 22 for details of how to make a loopback plug. To start an Ethernet interface test, use the command:

```
ENABLE TEST INT=PORT $n$ 
```

where  $n$  is the Ethernet interface number. The test will run for 4 minutes. Use the SHOW TEST command to observe the test progress.

## Other Interface Tests

Refer to the *Test Facility* chapter of the *Rapier Switch Software Reference* for information on testing other interfaces.



---

*If a test fails, please contact your Authorised Allied Telesyn distributor or reseller.*

---

## Troubleshooting

This section provides information on how to detect and resolve problems with the Rapier Switch and its expansion options.

Other sources of useful troubleshooting information are:

- [www.alliedtelesyn.co.nz/support/rapier](http://www.alliedtelesyn.co.nz/support/rapier).
- The *Rapier Switch Software Reference*.

**Performing the following tasks will eliminate the most common faults.**

1. Make sure the power cord is securely connected.
2. Check that the power supply voltage is stable.
3. Check that the correct data cables are being used and that their connections are secure.
4. Make sure that other network devices are working properly.
5. Use the SHOW INSTALL command to check that the latest software release is loaded. See the *Rapier Switch Software Reference* for more information about obtaining the latest software release.
6. If the switch is malfunctioning, reboot it by pressing the recessed Reset button or entering the command RESTART REBOOT. Alternatively, power OFF and ON the switch by disconnecting and reconnecting the main power supply (including, if connected, the RPS power).

## LEDs and What They Mean

The following tables outline how the Switch, Uplink Module and PIC LEDs report faults and operational activities. Uplink Modules, NSMs, and PICs are expansion options and can be purchased separately. Contact an Authorised Allied Telesyn distributor or reseller, or visit [www.alliedtelesyn.co.nz](http://www.alliedtelesyn.co.nz) for more information on purchasing expansion options.

## Switch LEDs

These LEDs are on the front or rear panels of Rapier Switches.

**Table 11: System LEDs (Common to all Rapier and Rapier *i* Switch models).**

LED	State	Function
Power	Green	The switch is receiving power and the voltage is within the acceptable range
Fault	Red	The switch or management software is malfunctioning
	1 flash	A switch fan has failed. (The LEDs will not indicate an RPS fan failure.)
	3 flashes	If an RPS is connected, the switch's PSU (Power Supply Unit) has failed
	4 flashes	If RPS monitoring is enabled, the RPS PSU has failed
	5 flashes	If RPS monitoring is enabled, an RPS is not connected or is not operational
RPS <sup>1</sup> (Redundant Power Supply)	Green	An RPS is connected to the switch
In use <sup>2</sup> (Rear panel)	Green	An NSM is installed, is receiving power, and is operational. The NSM and its PICs are not ready to be hot swapped
	Off	No NSM is installed, or the NSM is not installed correctly (the switch unit has not recognised the NSM)
Swap <sup>2</sup> (Rear panel)	Green	The NSM and its PICs are ready to be hot swapped
	Off	The Hot Swap button must be pressed before the NSM or PICs can be hot swapped, or the software release does not support hot swapping <sup>3</sup>

1. DC models of the Rapier Switch do not have an RPS connector and the RPS LED will not function
2. Not included on the Rapier 48, G6, G6F-SX/SC, G6F-X/SC, or G6F-SX/MT-RJ.
3. Hot swapping is supported by Software Release 2.3.1 or later. AT-AR021 (S) BRI-S/T, AT-AR021 (U) BRI-U, and AT-AR023 SYN PICs can be hot swapped.

**Table 12: Switch Port LEDs (Rapier G6).**

LED	State	Function
L/A (Link/Activity)	Green	A 1000 Mbps link is open
	Amber	A 10 Mbps or 100 Mbps link is open
	Flashing Green	1000 Mbps activity is occurring
	Flashing Amber	10 Mbps or 100 Mbps activity is occurring
D/C (Duplex/Collision)	Green	The port is operating at full-duplex
	Amber	The port is operating at half-duplex
	Flashing Amber	Collisions are occurring on the line

**Table 13: Switch Port LEDs (Rapier G6F-LX/SC, G6F-SX/SC, and G6F-SX/MT-RJ).**

LED	State	Function
L/A (Link/Activity)	Green	A 1000 Mbps link is open
	Flashing Green	1000 Mbps activity is occurring
D/C (Duplex/Collision)	Green	The port is operating at full-duplex
	Amber	The port is operating at half-duplex
	Flashing Amber	Collisions are occurring on the line

**Table 14: Switch Port LEDs (Rapier 8/8SC, Rapier 8/8MT, Rapier 24 and 48, and Rapier 24i and 48i).**

LED	State	Function
L/A (Link/Activity)	Green	A 100 Mbps link is open
	Flashing Green	100 Mbps activity is occurring
	Amber	A 10 Mbps link is open
	Flashing Amber	10 Mbps activity is occurring
D/C (Duplex/Collision)	Green	The port is operating at full-duplex
	Amber	The port is operating at half-duplex
	Flashing Amber	Collisions are occurring on the line

**Table 15: Switch Port LEDs (Rapier 16F-FX/SC and 16Fi-FX/SC, and Rapier 16F-FX/MT-RJ and 16Fi-FX/MT-RJ).**

LED	State	Function
L/A (Link/Activity)	Green	A 100 Mbps link is open
	Flashing Green	100 Mbps activity is occurring
D/C (Duplex/Collision)	Green	The port is operating at full-duplex
	Amber	The port is operating at half-duplex
	Flashing Amber	Collisions are occurring on the line

### Uplink Module LEDs

The following tables may be helpful when diagnosing possible operational faults. These LEDs are located on the face-plate of the respective Uplink Module model. Uplink Modules are expansion options and must be purchased separately.

**Table 16: Uplink Module LEDs (AT-A35-SX/SC and AT-A35-LX/SC).**

LED	State	Function
Link	Green	The port is receiving light
	Off	No link is present
Activity	Flashing Amber	Frames are being transmitted or received through the port
	Off	No activity is occurring

**Table 17: Uplink Module LEDs (AT-A39-T/RJ-45).**

LED	State	Function
Full Dup/Half Dup/Col	Green	The port is operating at full-duplex
	Amber	The port is operating at half-duplex
	Flashing amber	Collisions are occurring
	Off	No link is present
Activity	Green	A 1000 Mbps link is open
	Flashing green	1000 Mbps activity is occurring
	Amber <sup>1</sup>	A 10/100 Mbps link is open
	Flashing Amber <sup>1</sup>	10/100 Mbps activity is occurring
	Off	No link is present

1. Early versions of the AT-A39/T operate at 1000 Mbps only. 10/100/1000 Mbps operation is available only if the AT-A39/T Uplink Module is installed in a Rapier G6, Rapier G6F or Rapier *i* model, otherwise operation is fixed at 1000 Mbps.

**Table: 18 AT-A40/SC, AT-A40/MT, AT-A41/SC and AT-A41/MT LEDs<sup>1</sup>.**

LED	State	Function
Activity/Link/Fault	Green	A link is open and the port is enabled
	Flashing green	100 Mbps activity is occurring
	Flashing amber (and lower LED is Off)	The link has failed at the remote end
	Off	No link is present
Full Dup/Half Dup/Col	Green	The port is operating at full-duplex
	Amber	The port is operating at half-duplex
	Flashing amber	Collisions are occurring
	Off	No link is present
Both LEDs	Alternate flashing of upper and lower LED, amber	The switch does not support this model of uplink module

1. AT-A40 and AT-A41 Uplink Modules can be installed in Rapier G6 and G6F switches and all Rapier *i* switches.

**Table: 19 AT-A42/GBIC LEDs .**

LED	State	Function
L/A Link/Activity	Green	A 1000 Mbps link is open
	Flashing green	1000 Mbps activity is occurring
	Flashing amber (and GBIC LED is Off)	A TX fault has occurred
	Off	No link is present
GBIC	Green	The switch has recognised the GBIC, the GBIC is a valid model
	Green (and L/A LED is flashing GREEN)	The port is operating at full-duplex
	Amber (and L/A LED is OFF)	The switch has not recognised the GBIC, the GBIC is not a valid model
	Amber (and L/A LED is flashing GREEN)	The port is operating at half-duplex
	Flashing amber (and L/A LED is flashing GREEN)	Collisions are occurring
	Off	No GBIC is installed, or a TX fault has occurred
Both LEDs	Slow alternate flashing of L/A and GBIC LED, amber	The switch has not recognised the GBIC, or the GBIC is not a valid model

## NSM LEDs

NSMs are expansion options and must be purchased separately. They can be used with all Rapier models except the Rapier 48, Rapier 48*i*, G6, G6F/SX, G6F/LX, and G6F/MT.

The AT-AR040 NSM unit has no independent LEDs. See Table 11 on page 28 for information about related LEDs found on the base-unit switch or router.

The LEDs in Table 20 are located on the face-plates of AT-AR041 and AT-AR042 NSMs.

**Table 20: AT-AR041 and AT-AR042 LEDs.**

LED	State	Function
Active	Green	Lit when the BRI has successfully completed the exchange of INFO 1 and INFO 2 signals, and INFO 3 and INFO 4 signals are present on the link. This means the ISDN interface is correctly connected to a working NT device.
	Off	No BRI activity is occurring.
Data	Amber	Pulses when HDLC packets are being exchanged between the switch or router and the ISDN switch over the B and D channels.
	Off	No data exchange is occurring.

The LEDs in Table 21 are located on the face-plate of AT-AR048 NSMs

**Table 21: AT-AR048 LEDs.**

LED	State	Function
Active	Green	Lit when the Line Interface Unit (LIU) is receiving a signal
Loop	Green	Lit when any loopback is active
LOS	Amber	Lit when the received signal is lost. This usually indicates a network disruption, such as a cable being disconnected or a device failure
LOF	Amber	Lit when the DS3 framer cannot extract valid frames from the received signal
AIS	Amber	Lit when an Alarm Indication Signal is detected
FERF	Amber	Lit when a Far End Receive Failure signal is detected. This indicates the far end is receiving an AIS, LOS, or LOF signal

## PIC LEDs

PICs are expansion options and must be purchased separately. They can only be used if an AT-AR040 NSM is installed in the switch. NSMs (and therefore PICs) can be used with all Rapier models except the Rapier 48, Rapier 48*i*, G6, G6F/SX, G6F/LX, and G6F/MT.

These LEDs are located on the face-plate of the respective PIC.

**Table 22: PIC LEDs (AT-AR020 PRI E1/T1).**

LED	Function
D Data	[ISDN mode only] Lit when HDLC packets are being exchanged between the switch and the ISDN switch over the D (signalling) channel.
B Data	Lit when HDLC packets are being exchanged between the switch and another end system device (normally another switch or router) over any of the B (data) channels.
Active	Lit whenever operational (i.e., no RAI or AIS) frames are being received from another source.
NT	[ISDN mode only] Lit when the PRI1 is operating in NT mode. This LED should not be lit during normal operation.

**Table 23: PIC LEDs (AT-AR021(S) BRI-S/T).**

LED	Function
B1, B2	For on-demand ISDN, lit when there is a call up over the respective B channel and flashing when data is being exchanged. For permanent circuits, lit when HDLC packets are being exchanged between the switch or router and another TE end system device (normally another switch or router) over the respective B (data) channel.
Active	Lit when the BRI has successfully completed the exchange of INFO 1 and INFO 2 signals, and INFO 3 and INFO 4 signals are present on the link. This means that the ISDN interface is correctly connected to a working NT device.
D	Lit when HDLC packets are being exchanged between the switch and the ISDN switch over the D (signalling) channel.

**Table 24: PIC LEDs (AT-AR021(U) BRI-U).**

LED	Function
B1, B2	Lit when HDLC packets are being exchanged between the switch and another TE end system device (normally another switch or router) over the respective B (data) channel. For ISDN, lit when there is a call up over the respective B channel and flashing when data is being exchanged.
Active	Lit when the U interface is in the <i>Activated</i> state (i.e., it is fully operational at layer 1).
D	Lit when HDLC packets are being exchanged between the switch and the ISDN switch over the D (signalling) channel.

**Table 25: PIC LEDs (AT-AR023 SYN).**

LED	Function
Tx	Lit when data is being transmitted over the synchronous interface.
Rx	Lit when data is being received over the synchronous interface.

**Table 26: AT-AR026 4ETH PIC LED functions (Two LEDs per port).**

LED	Function
Left	Lit when the port is operating at 100Mbps and full duplex.
Right	Lit when a link has been established. Flashing when data is being transmitted through the port.

**Table 27: AT-AR027 VoIP-FXS PIC LED functions.**

LED	State	Function
Off Hook/Ring	Off	The port is on-hook
	Green	The port is off-hook
	Flashing	An incoming call is present on the port
PIC Reg	Off	The PIC is not registered with a gatekeeper and external phone calls cannot be made
	Flashing	The PIC is registered with a gatekeeper or gatekeeper has been set to "None". External calls can only be made if the PIC is registered with a gatekeeper
PIC Error	Off	The PIC is okay
	Green	An internal error has occurred. Reset the PIC using the RESET VOIP command

The AT-AR024 ASYN4 PIC does not have LEDs.

## Some common problems and how to solve them

Link/Activity LED on any port is off

This can indicate:

- A loose data cable.
- The device at the other end of the connection is not working properly or is turned off.
- The data cable is not wired correctly.
- The network administrator has manually disabled the port through the software.
- The port's selected transmission mode does not match that of the attached device.

Perform the following steps in sequence:

1. Make sure the data cable connections are secure.
2. Make sure the device at the other end of the connection is switched on and working properly.
3. Check that the data cable is wired correctly.

4. If you can, log in and check the port status. See “To Log In” on page 12 for more information on how to log in.
5. If the port is Enabled, make sure the transmission speed matches that of the connected device (auto-negotiating, full or half-duplex).



---

*If the port is disabled, someone has used the software to manually disable it. You should find out why the port was disabled before enabling it.*

---

### Power LED is off

This can indicate:

- A loose power cord.
- A power supply failure.

Perform the following steps in sequence:

1. Check that the power cord connections are secure.
2. Check that all switches and circuit protection devices are in the ON position.
3. Ensure that the supply voltage is within the operational range (110/240 VAC 50/60 Hz for AC models, 39-60 VDC for DC models).

### Fault LED is on

This can indicate:

- There is a problem with the switch or RPS PSU.
- The switch or management software is malfunctioning.
- A hardware fault is preventing switch start-up.

Perform the following steps in sequence:

1. Check Table 11 on page 28 for descriptions and explanations of LED flashing sequences.
2. Reset the switch by pressing the recessed RESET button on the front panel.
3. If you were attempting to download software or manage the switch via the RS-232 terminal Port, check that connections between the Terminal Port and local terminal or PC are secure.

If you cannot access the switch's software because of a faulty RS-232 Terminal Port connection, you can still manage the switch via Telnet or SNMP until the problem is fixed.

4. Unplug the switch and then plug it in again. If present, you will also have to disconnect and reconnect the RPS unit.
5. Download the latest software release. See the *Rapier Switch Software Reference* for more information on how to obtain the latest software release.

## Expansion Options

---

This section provides an overview of the expansion options for Rapier Switches. The following expansion options were available when this Reference was written. See your Authorised Allied Telesyn distributor or reseller, or visit [www.alliedtelesyn.co.nz/support/rapier](http://www.alliedtelesyn.co.nz/support/rapier) to see if any new options are available.

### Uplink Modules

Uplink Modules increase switching capacity by providing a maximum of two extra ports and by allowing switches to be linked together in stacks. For the Rapier series, Uplink Modules with gigabit capacity are available.

Uplink Modules in the following list are the only modules that should be installed into Rapier Switches. Check with your Authorised Allied Telesyn distributor or reseller, or visit [www.alliedtelesyn.co.nz/support/rapier](http://www.alliedtelesyn.co.nz/support/rapier) to see if any new Uplink Module models are available.

Uplink Modules currently available include:

- AT-A35-SX/SC 1-port 1000BASE-SX (SC connector)
- AT-A35-LX/SC 1-port 1000BASE-LX (SC connector)
- AT-A39-T/RJ-45 1-port 1000BASE-T (RJ-45 copper connector)
- AT-A40/SC 1-port 100BASE-FX Multimode Fibre (SC connector)<sup>1</sup>
- AT-A40/MT 1-port 100BASE-FX Multimode Fibre (MT-RJ connector)<sup>1</sup>
- AT-A41/SC 1-port 100BASE-FX Singlemode Fibre (SC connector)<sup>1</sup>
- AT-A41/MT 1-port 100BASE-FX Singlemode Fibre (MT-RJ connector)<sup>1</sup>
- AT-A42/GBIC 1-port 1000BASE-X (GBIC slot)

1. AT-A40 and AT-A41 Uplink Modules can be installed in Rapier G6 and G6F switches and all Rapier *i* switches.



---

*For more information on Uplink Modules, contact your Authorised Allied Telesyn distributor or reseller, or see the Uplink Module Hardware Reference. This and other documentation can be found on the Rapier Switch Documentation and Tools CD-ROM bundled with your switch, or at [www.alliedtelesyn.co.nz/support/rapier](http://www.alliedtelesyn.co.nz/support/rapier).*

---

### Network Service Modules

The following Rapier switches include an NSM expansion bay:

- Rapier 24
- Rapier 24i
- Rapier 16F-FX/SC
- Rapier 16Fi-FX/SC
- Rapier 16F-FX/MT
- Rapier 16Fi-FX/MT
- Rapier 8/8SC
- Rapier 8/8MT

NSMs slot into a base-unit switch and either directly provide additional interfaces, or provide multiple slots where additional interfaces can be added.

Four NSMs are currently available:

- AT-AR040 (4 Port Interface Card (PIC) slots)
- AT-AR041 (8 BRI S/T WAN Ports)
- AT-AR042 (4 BRI S/T WAN Ports)
- AT-AR048 (1 unchannelised DS3 port)<sup>1</sup>

1. The AT-AR048 can only be used in Rapier 24i models whose serial number ends in J or higher (N or higher for maximum performance). A label with the serial number can be found on the underside of the switch.



---

*For more information on NSMs, contact your Authorised Allied Telesyn distributor or reseller, or see the Network Service Module Hardware Reference. This and other documentation can be found on the CD-ROM bundled with your switch, or at [www.alliedtelesyn.co.nz/support/rapier](http://www.alliedtelesyn.co.nz/support/rapier).*

---

## Port Interface Cards (PICs)

PICs provide a cost effective and flexible mechanism for adding new or additional WAN network interfaces to the switch. By adding or changing PICs, the switch's network interface capabilities can be upgraded without replacing the switch itself. A PIC can provide additional network interfaces, or can be replaced with a different PIC to provide alternative interface types.

An AT-AR040 NSM must be installed before PICs can be used with Rapier Switches.

The following PICs can be used in the AT-AR040 NSM when it is installed in a Rapier switch (with a maximum of two E1/T1/PRI cards):

- AT-AR020 PRI E1/T1
- AT-AR021 (S) BRI- S/T\*
- AT-AR021 (U) BRI-U\*
- AT-AR023 SYN\*
- AT-AR024 ASYN4
- AT-AR027 VoIP-FXS

\* These PICs can be hot swapped if the host Rapier is running Software Release 2.3.1 or later. See the *Port Interface Card Hardware Reference* for more information.



---

*AT-AR022 ETH PICs and AT-AR026 4ETH PICs are not recommended for use in the NSM PIC bays, as performance of these interfaces is likely to be reduced and packet loss may occur.*

---



---

*For more information on PICs, contact your Authorised Allied Telesyn distributor or reseller, or see the Port Interface Card Hardware Reference. This and other documentation can be found on the CD-ROM bundled with your switch, or at [www.alliedtelesyn.co.nz/support/rapier](http://www.alliedtelesyn.co.nz/support/rapier).*

---

## PCI Accelerator Cards (PACs)

PCI Accelerator Cards (PACs) provide additional processing features or performance, but do not add extra physical interfaces to the switch. A PAC can be installed in the dedicated PAC slot on all Rapier switches except the Rapier 48, Rapier 48i, Rapier G6, and Rapier G6F.



*PACs should only be installed by authorised service personnel. Unauthorised opening of the switch's lid may cause danger of injury from electric shock, damage to the switch, and invalidation of the product warranty.*

Two PACs are available:

- AT-AR060 EPAC, Encryption PAC.
- AT-AR061 ECPAC, Encryption/Compression PAC.

See "Restricted Procedures" on page 39 for more information on the PAC installation procedure.

### How PACs work

PACs provide Rapier switches with high performance hardware-based encryption and/or compression services. PACs have a DMA slave processor, which operates independently of the base system. This processor is responsible for the transfer of data between the base system and the PAC, and the control of local high speed encryption and compression data processing devices.

This architecture allows data encoding to be performed off-line without involving the base switch processor, thereby maximising PAC performance while at the same time minimising impact on the switch.

The PAC is a single card. Figure 22 on page 38 shows the layout of the board for an AT-AR061 ECPAC.

**Figure 22: Location of main components on the AT-AR061 ECPAC card.**

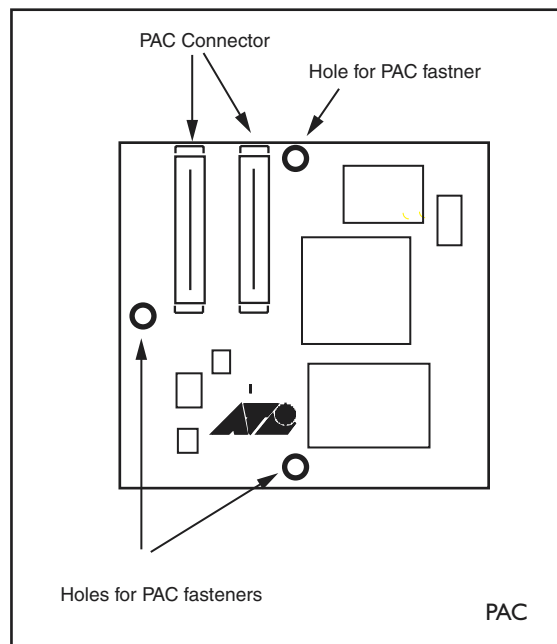

## Compression

PAC-based compression has the following features:

- Local 32-bit processor for high speed control and data transfer.
- Dedicated high performance 32-bit compression hardware.
- High compression ratio Lempel-Ziv algorithm in hardware.
- 2 MBytes of history memory.
- Support for up to 127 compression channels.

Compression and decompression operations are performed by a 32-bit data compression coprocessor specifically designed for high-performance Lempel-Ziv compression applications. The 2 MBytes of history memory allows up to 127 individual data links to use compression concurrently, enabling PACs to provide compression for complicated network architectures. Figure 23 on page 39 shows typical compression ratios achieved by a PAC for a representative set of file types.

**Figure 23: Typical hardware compression ratios by file type.**

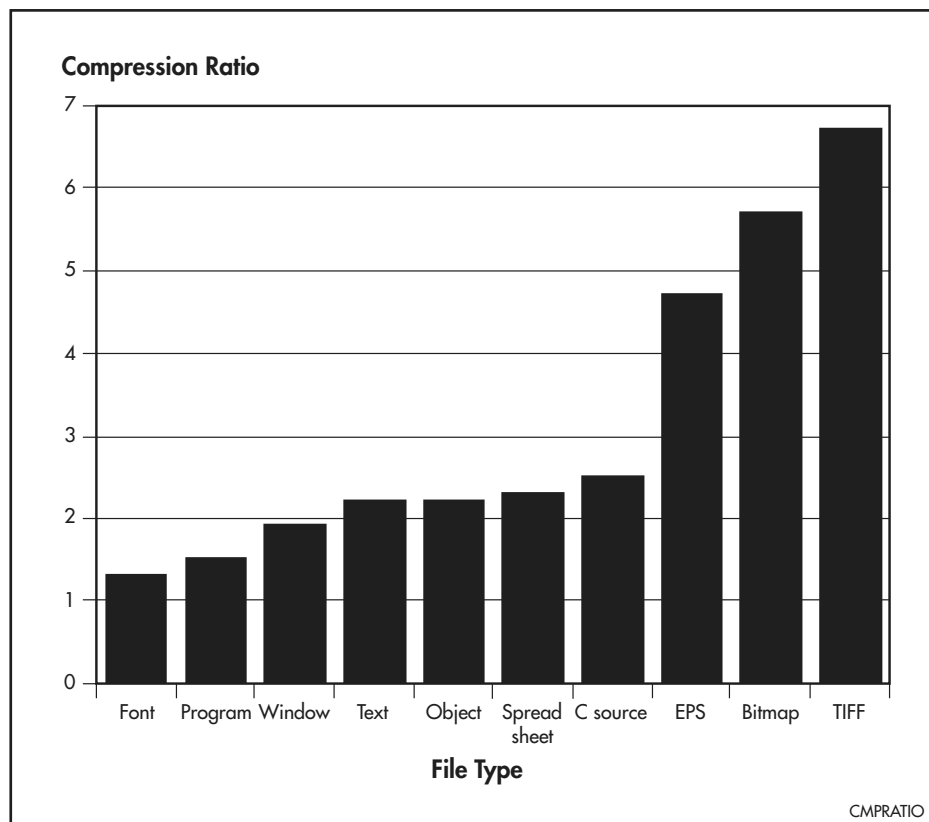

## Encryption

PAC-based encryption has the following features:

- Local 32-bit processor for high speed control and data transfer.
- Dedicated high performance 32-bit Data Encryption Standard – DES and Triple DES (3DES) – hardware.

PAC DES and triple DES encryption are based on a fast 32-bit device that complies with FIPS PUB 46, ISO DEA-1 and ANSI X3.92 standards.

## Dual Mode

Throughput of an encrypted link can be dramatically increased by using data compression. To support this, ECPACs support both encryption and compression, providing a dual mode that allows combined compression and encryption operations. So that the compression phase will have the best opportunity at finding non-random data, compression occurs before encryption, in the order:

compression → encryption →//→ decryption → decompression

Adding compression to an encrypted link increases line throughput. Once compression has been carried out there is less data requiring encryption, passing back to the base system, and transferring across the network, so less base system bus and network link bandwidth is required for a given amount of data. This results in the dual operation being very effective where encryption is required.

## Port, Connector, and Cable Combinations

This section provides cabling guidelines for each switch model.

**Table 28: Cable guidelines.**

Model	Port Type(s)	Connector Type(s)	Cable Type <sup>1</sup>	Maximum Cable Length
Rapier 8/8SC Rapier 8/8MT Rapier 24 Rapier 24i Rapier 48 Rapier 48i	10BASE-T/ 100BASE-TX	RJ-45	10BASE-T Category 3 or better 100BASE-TX Category 5 or better	100m (328ft) 100m (328ft)
Rapier 16F-FX/SC Rapier 16Fi-FX/SC Rapier 8/8/SC	100BASE-FX	SC	50/125 or 62.5/125 micron multimode fibre	Full-duplex 2km (6,600ft) Half-duplex 412m (1360ft)
Rapier 16F-FX/MT-RJ Rapier 16Fi-FX/MT-RJ Rapier 8/8MT	100BASE-FX	MT-RJ	50/125 or 62.5/125 micron multimode fibre	Full-duplex 2km (6,600ft) Half-duplex 412m (1360ft)
Rapier G6	1000BASE-T	RJ-45	CAT5	100 (328ft)
Rapier G6F-LX/SC	1000BASE-LX	SC	9/125 micron singlemode fibre 50/125 or 62.5/125 micron multimode fibre	3km (1.8mi) Increasing to 10km (6mi) if linking two 1000BASE-LX models 550m (1804ft) <sup>2</sup>
Rapier G6F-SX/SC	1000BASE-SX	SC	50/125 micron multimode fibre 62.5/125 micron multimode fibre	550m (1,804ft) <sup>2</sup> 275m (902ft) <sup>3</sup>
Rapier G6F-SX/MT-RJ	1000BASE-SX	MT-RJ	50/125 micron multimode fibre 62.5/125 micron multimode fibre	550m (1,804ft) <sup>2</sup> 275m (902ft) <sup>3</sup>

1. Refer to the IEEE 802.3 standards for further cable information

2. Assumes a fibre optic cable rating of 500 Mhz/Km. (Maximum cable length is 500m at a cable rating of 400 Mhz/Km.)

3. Assumes a fibre optic cable rating of 200 Mhz/Km. (Maximum cable length is 220m at a cable rating of 160 Mhz/Km.)

## Using Windows Terminal and Windows Hyperterminal

You can use a PC running terminal emulation software as the manager console, instead of a terminal. There are many terminal emulation applications available for PCs, but the most readily available are the Terminal and HyperTerminal applications included in Microsoft Windows 95, 98, 2000, and Windows NT 4.0. In standard Windows installations, HyperTerminal is located in the Start > Programs > Accessories menu.

The key to successful use of terminal emulation software with the switch is to configure the software and switch with matching communications parameters. The following procedures describe how to configure Windows Terminal and HyperTerminal for the default RS-232 Terminal Port settings on the switch, but the same principles apply to other terminal emulation programs.

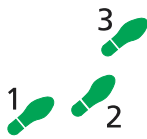

### To configure Windows HyperTerminal for Windows 95, 98, 2000, & NT 4.0.

#### 1. In Windows, select:

- Programs > Accessories > HyperTerminal.
- Double-click the Hypertrm.exe icon.

#### 2. In the Connection Description dialog box:

- Enter a name for the connection (e.g., Rapier 24)
- Select an icon from the scrolling list.
- Click "OK".

#### 3. In the Phone Number dialog box:

From the "Connect using:" drop-down list, select:

- "Direct to Com n" Where "COM n" is the COM port on the PC used to connect to the switch.
- Click "OK".



**4. In the COMn Properties dialog box, set:**

- Bits per second: 9600.
- Data bits: 8.
- Parity: None.
- Stop bits: 1.
- Flow control: Hardware.
- Click “OK”.

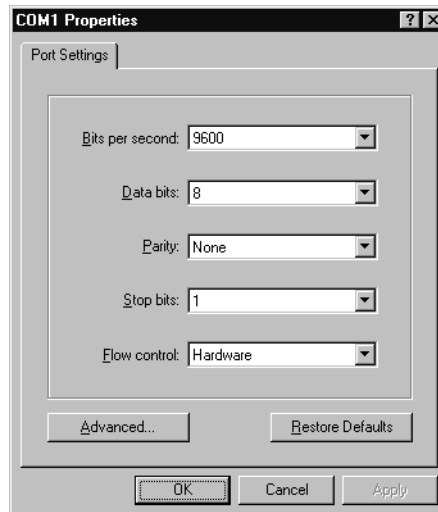
**5. From the File menu, select:**

- “Properties”

In the Connection Properties dialog box, click the Settings tab and set:

- “Function, arrow, and ctrl keys act as” to “Terminal keys”
- “Emulation” to VT100.



6. Click "ASCII Setup" to display the ASCII Setup dialog box. Uncheck:
- "Echo typed characters locally".
  - "Append line feeds to incoming line ends".
- Set other parameters as required.
- Click "OK" twice to close all dialog boxes.

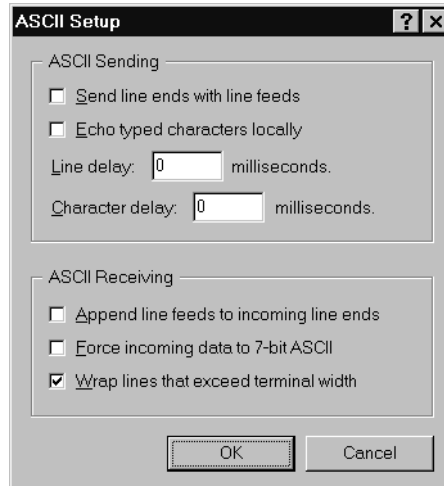

7. Save the current session. From the File menu, select:
- "Save".

This creates a connection icon with the name you assigned in the HyperTerminal group. To use the configuration:

- Double-click the connection icon in the HyperTerminal group.

When the HyperTerminal window appears, press:

- [Enter] a couple of times.

The switch's log in prompt will appear.

## Restricted Procedures

This section contains procedures that should only be performed by authorised service personnel. Unauthorised use of procedures in this section may cause danger of injury from electric shock, damage to the switch, and invalidation of the product warranty.

If you would like to know more about the procedures outlined in this section, please contact your authorised Allied Telesyn distributor or reseller.

## Diagnostics

The switch software includes a set of diagnostic programs. These programs perform basic level checks of all system components. They do not run in conjunction with the normal operating code, and require that the system be totally dedicated to their use. A detailed knowledge of the way the switch hardware functions is necessary if diagnostics is to be used effectively.



The switch will not perform switching operations if diagnostics are running.



Diagnostics will not perform checks on AT-AR026 PICs.



This section is not intended as a guide to the diagnostics software. Diagnostics are designed to be run by service personnel only. For more information, contact your Authorised Allied Telesyn distributor or reseller.

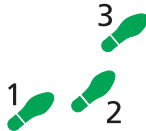

### To enable diagnostics mode:

#### 1. Connect a terminal to the RS-232 Terminal Port.

Using an RS-232 DB9 straight-through cable, connect a terminal to the RS-232 Terminal Port on the switch.

Set the terminal communication parameters to the following:

- Baud rate: 9600
- Data bits: 8
- Parity: None
- Stop bits: 1
- Flow control: Hardware

#### 2. Restart the switch.

Restart the switch, either by using a pen or pencil to operate the recessed reset button on the front panel, or by using the terminal to log in and enter the command:

```
RESTART REBOOT
```

See “To Log In” on page 12 for more information on how to log in.

#### 3. Enable diagnostics mode during start-up.

During the switch start-up process, at the prompt:

```
Force EPROM download (Y)?
```

press [Ctrl/D] on the terminal to enter diagnostics mode. A banner page will be displayed on the terminal (Figure 24 on page 45). This can be used to check that the terminal is correctly connected.

**Figure 24: Rapier Switch diagnostics banner page.**

```
* * * Diagnostic Mode * * *

version 16-Mar-98

Main Menu:
 0. Restart
 1. Full RAM test
 2. ROM checksum test
 3. Full FLASH test
 4. Totally Erase FLASH
 5. Battery backed RAM test
Enter selection ==>
```

To run a diagnostic program, enter the corresponding letter or number (or key). There are several sub-menus to cover all the available options. Table 28 on page 41 lists the control keys for diagnostic operations.

**Table 29: Basic commands for running the diagnostics.**

Key	Function
Q	Quits any running tests and displays the banner page.
S	Prints a summary of test results so far.

A reasonable understanding of the system's structure is needed to operate diagnostics and interpret the results.

To restore the switch to normal operation, use a pen or pencil to operate the recessed reset button on the front panel, or press "0" (zero) to restart.

## Installing a PAC

PACs can be installed in all Rapier switches except the Rapier 48, Rapier 48i, Rapier G6, and Rapier G6F.



*PACs should only be installed by authorised service personnel. Unauthorised opening of the switch's lid may cause danger of injury from electric shock, damage to the switch, and invalidation of the product warranty.*

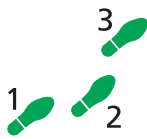

### Before installing a PAC:

1. **Check that you have the correct tools and equipment.**

You will need a medium-sized posidrive screwdriver.

2. **Avoid injury by working in a safe environment.**

The workspace should be free of hazards, and there should be sufficient room to lay out the switch, PAC, and tools.

3. **Unpack the PAC in an antistatic environment.**



*Do not attempt to install any hardware without observing correct antistatic procedures. Failure to do so may damage the switch or PAC. If you are unsure what the 'correct' procedures are, contact your authorised Allied Telesyn distributor or reseller.*

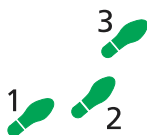

### To install a PAC:

1. **If fitted, disconnect the switch's redundant power supply.**

2. **Disconnect the mains power cord.**



*Before removing the switch's lid, the power cord and, if connected, RPS power cord should be disconnected to reduce risk of electrical shock.*

3. **Remove all interface cables.**

#### 4. Remove the switch's lid.

The switch may need to be removed from any rack mounting system before its lid can be removed.

Using a posidrive screwdriver, remove the 12 screws that secure the switch's lid. There are 5 screws located in countersunk holes on each side of the lid, and 2 screws at the rear.

#### 5. If not already installed, install the PAC pillars.

Each PAC is shipped with six pillars (three plastic and three metal). If installing the PAC in a Rapier 24, use the plastic pillars. If installing the PAC in any other model of Rapier, use the metal pillars.

Carefully screw the appropriate pillars into the three threaded pillar mounts on the switch's base board. The pillars should be firm but not overtight.

Figure 25 on page 47 shows the PAC pillar mounts on a Rapier base board.

**Figure 25: Location of PAC slot and pillar mounts on a Rapier base board.**

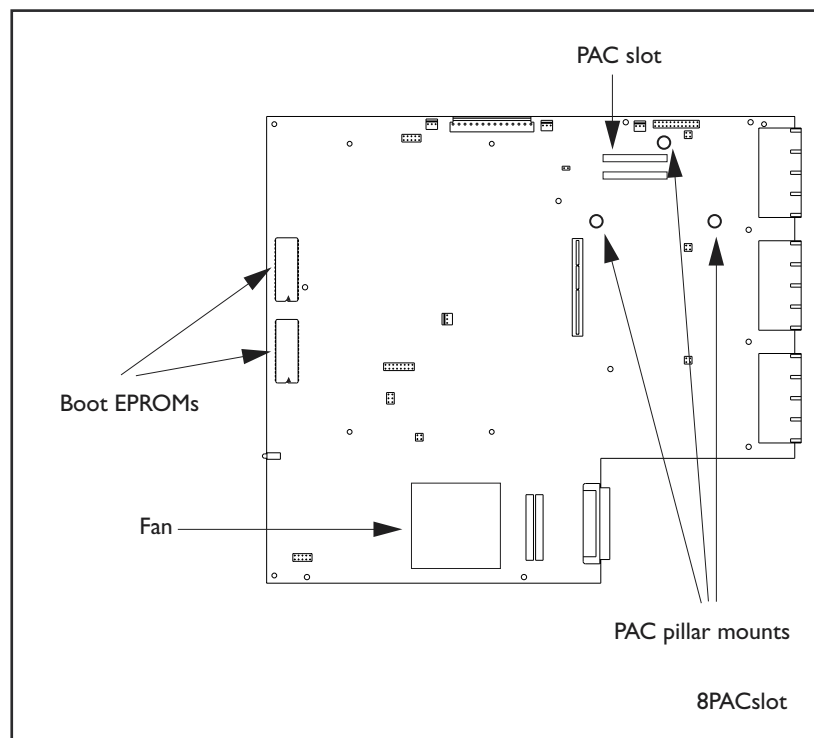

#### 6. Insert the PAC.

Position the PAC over the PAC slot on the switch base card, making sure that the support pillars located on the switch base card are aligned with the holes provided on the PAC. This ensures that the connector on the PAC is correctly aligned with the slot on the switch base card.

Press the connector firmly into place. Secure the PAC to its three pillars using the fasteners supplied.

Figure 25 on page 47 shows the PAC slot on a Rapier base board.

**7. Replace the switch's lid and the power cord.**

Secure the switch's lid. If you disconnected an RPS supply, reconnect it now.

**8. If you disconnected interface cables to install the PAC, reconnect them.**

The PAC is now ready to test.

**Testing a PAC**

There are several ways to check that the PAC is installed and operating correctly. First, check that the switch has recognised the card. Turn on the switch and enter the command:

```
SHOW SYSTEM
```

to display system information (Figure 26 on page 49).

The first part of the display shows details of the cards installed in the switch. There should be at least two entries, one for the switch base card and one for the PAC. Both the serial number and the part name should be displayed.

If there is no entry for the PAC then the switch's boot process has not correctly detected the PAC's presence. The most likely cause is that the PAC is not correctly plugged into the slot on the switch's base board. Repeat the installation process, paying particular attention to Step 6.

Use the SHOW SYSTEM command again, and if the display is still not correct, contact your authorised Allied Telesyn distributor or reseller.



---

*If you have any difficulty with the PAC at any time, contact your authorised Allied Telesyn distributor or reseller and quote the serial numbers of both the base card on the switch and the PAC. The serial numbers and revision details can be read using the SHOW SYSTEM command. It's a good idea to record this information for later reference.*

---

**Figure 26: Example output from the SHOW SYSTEM command for a Rapier switch with an AT-AR061 ECPAC installed.**

```

Switch System Status                               Time 00:23:04 Date
15-Jun-2001.
Board      ID  Bay Board Name                               Rev   Serial number
-----
Base       86      AT-RP24   Rapier 24                               M2-1  46690596
NSM 4PIC   87      AT-AR040-00 NSM 4PIC                               M3-3  6845206
PIC        38      1  AT-AR023-00 PIC Sync                       M1-1  8618528
PAC        153     AR061 ECPAC                               P1-16 6844578
-----
Memory -   DRAM : 32768 kB   FLASH : 6144 kB
-----
SysDescription
Allied Telesyn AT-RP24 version 2.2.2-00 18-May-2001
SysContact

SysLocation

SysName

SysDistName

SysUpTime
102398 ( 00:17:03 )
Software Version: 2.2.2-00 18-May-2001
Release Version : 2.2.2-00 18-May-2001
Release built   : Jun 15 2001 at 05:03:04
Patch Installed : NONE
Territory       : europe
Help File       : help.hlp

Main PSU        : On           Main Fan        : On
RPS Monitor     : Off

Boot configuration file: Not set
Current configuration: None
Security Mode   : Disabled

Warning (248283): No patches found.

```

Next, check the PAC's status using the command:

```
SHOW LOG
```

to display a log of PAC events. A typical display is shown in Figure 27 on page 50.

**Figure 27: Example output from the SHOW LOG command for a Rapier switch with an AT-AR061 ECPAC card installed.**

Date/Time	S	Mod	Type	SType	Message
15 00:05:50	4	ENCO	ENCO	PAC	7751 Found. Initialisation started
15 00:05:50	4	ENCO	ENCO	PAC	7751 Initialisation Successful
15 00:05:50	7	SYS	REST	NORM	Switch startup, ver 2.2.2-00, 18-May-2001, Clock
					Log: 00:04:40 on 15-Jun-2001
15 00:05:53	3	USER	USER	00011	manager login failed on port0
15 00:05:58	3	USER	USER	LON	manager login on port0
15 00:05:59	3	CH	MSG	WARN	No patches found



*If any PAC tests fail, check that the PAC is correctly installed in its slot and repeat the tests. Contact your authorised Allied Telesyn distributor or reseller if the PAC does not operate correctly.*

Once the PAC is operating, its functionality can be tested either by using the Test Facility software, which is built into the switch, or by configuring a module to use the PAC. For more information about configuring interfaces, see the “Compression and Encryption Services” chapter of your switch’s Software Reference.

### Using the Test Facility to Verify Operation

The built-in Test Facility software is the easiest way to verify a PAC’s operation.



*See the Test Facility chapter of your switch’s Software Reference for more information about the Test Facility.*

To run the Test Facility for a PAC, use the command:

```
ENABLE TEST INTERFACE=PAC
```

The test will run for 4 minutes. To view the results of the test at any time, use the command:

```
SHOW TEST
```

Figure 28 on page 51 shows a typical output. The status of the test will be shown in the right-hand column. For further information on the meanings of the other figures, see the “Test Facility” chapter of your switch’s Software Reference.

**Figure 28: Example output from the SHOW TEST command for a Rapier switch with an AT-AR061 ECPAC installed.**

Board	ID	Bay	Board Name	Rev	Serial number
-----					
--					
Base	86		AT-RP24 Rapier 24	M2-1	46690596
NSM 4PIC	87		AT-AR040-00 NSM 4PIC	M3-3	6845206
PIC	38	1	AT-AR023-00 PIC Sync	M1-1	8618528
PAC	153		AR061 ECPAC	P1-16	6844578
-----					
Interface	State	Result	Type	Duration (minutes)	Details Data( %OK )
-----					
Control					
port1	no test	-	-	-	-
port2	no test	-	-	-	-
port3	no test	-	-	-	-
port4	no test	-	-	-	-
port5	no test	-	-	-	-
port6	no test	-	-	-	-
port7	no test	-	-	-	-
port8	no test	-	-	-	-
port9	no test	-	-	-	-
port10	no test	-	-	-	-
port11	no test	-	-	-	-
port12	no test	-	-	-	-
port13	no test	-	-	-	-
port14	no test	-	-	-	-
port15	no test	-	-	-	-
port16	no test	-	-	-	-
port17	no test	-	-	-	-
port18	no test	-	-	-	-
port19	no test	-	-	-	-
port20	no test	-	-	-	-
port21	no test	-	-	-	-
port22	no test	-	-	-	-
port23	no test	-	-	-	-
port24	no test	-	-	-	-
syn0	no test	-	-	-	-
asyn0	no test	-	-	-	-
enco0	testing	wait 4 minutes	DES	< 1	good(100.0) -
enco1	testing	wait 4 minutes	STAC	< 1	good(100.0) -
-----					

If you are unsure about running the Test Facility, or have difficulty evaluating the results then contact your authorised Allied Telesyn distributor or reseller.

## Replacing Boot EPROMs

Rapier Switches have two 512 kByte boot EPROMs. The boot EPROMs contain bootstrap code, which loads the main code from a software release file in FLASH memory. In rare circumstances the boot EPROM(s) may need to be changed.



---

*Boot EPROMs should not need to be replaced, except in rare circumstances. Contact your Authorised Allied Telesyn distributor or reseller before replacing any boot EPROMs.*

---

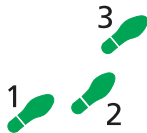

### To change the boot EPROMs:

**1. Check that you have the correct tools and equipment available.**

You will need a medium-sized posidrive screwdriver and an EPROM extraction tool (or a small flat-bladed screwdriver). In addition, adequate antistatic precautions must be used.



---

*EPROMs, like most electronic equipment, are highly sensitive to electrostatic damage. This can be particularly acute in the dry atmosphere normally associated with computer rooms and typical offices. Before commencing work, ensure that you have used an approved antistatic wrist strap to discharge any buildup of static electricity. Wear the strap at all times during the following procedure.*

---

**2. Avoid injury by working in a safe environment.**

The workspace should be free of hazards, and there should be sufficient room to lay out the switch, the EPROM, and the tools.

**3. Disconnect the mains power cord.**

**4. If fitted, disconnect the redundant power supply.**



---

*Do not take risks with mains or backup electricity. Do not attempt to remove the lid of the switch unless all power cords have been disconnected from the switch.*

---

**5. Remove the switch's lid.**

Using a posidrive screwdriver, remove the 12 screws that secure the switch's lid. There are 5 screws located in countersunk holes on each side of the lid, and 2 screws at the rear. The switch may need to be removed from any rack mounting system before its lid can be removed.

**6. Remove the existing boot EPROMs.**

The boot EPROM(s) should now be visible.

Figure 29 on page 53 shows the location of boot EPROMs on the CPU board.

Remove the boot EPROMs using the extraction tool. Alternatively, a small flat-bladed screwdriver can be used. If using a screwdriver, gently lever each end of a particular boot EPROM a few millimetres at a time until it comes free.

Figure 29: EPROM locations.

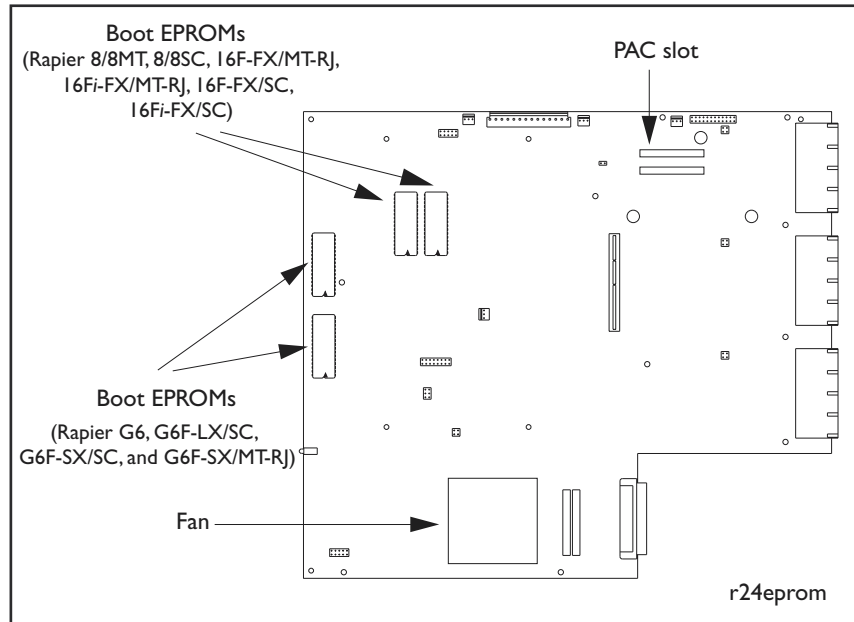

### 7. Insert the new boot EPROMs.

Insert the new boot EPROMs one at a time, using as a reference the location number printed on the CPU board (e.g., “0” and “1”) and Figure 29 on page 53. Check that the boot EPROMs are firmly seated.



*Install the boot EPROMs the correct way up! Failure to do so will almost certainly destroy them. The ‘top’ end of the EPROM has a notch. This should be positioned so that the notched end of the EPROM is orientated as shown in Figure 29 on page 53.*

### 8. Replace the switch’s lid and power cord.

Replace the lid and secure it with the 12 posidrive screws. Connect the power cord and (if disconnected in step 4) the RPS.

### 9. Check that the switch is operating correctly.

Check that the switch boots up correctly. Connect the switch’s RS-232 Terminal Port to a terminal (see page 20 for information on connection cables) and check the start-up messages. See “Switch Start-up” on page 12 for a list of start-up messages. Verify that the new software version is installed by typing the command:

```
SHOW INSTALL
```

which will produce a display like that shown in Figure 30 on page 54. The boot EPROM software release number is shown in the “Default” field. Check that it is correct.

**Figure 30: Example output from the SHOW INSTALL command.**

```

Install      Release                               Patch
-----
Temporary    -                                       -
Preferred    flash:load\86s-210.rez                -
Default      EPROM (86s-2.1.0)                     -
-----

Current install
-----
Preferred    flash:load\86s-210.rez                -
-----

Install history
-----
No Temporary install selected
Preferred install selected
Preferred release successfully installed
-----

```

## Troubleshooting EPROM Installation

If the switch fails to reboot or functions incorrectly, then the most likely cause is that there is a problem with the way the boot EPROMs were installed. Repeat the installation procedure, checking:

- That the boot EPROMs are in the correct locations and oriented correctly (using the relevant location diagram as a guide).
- For bent pins. These should be carefully straightened.

If the switch still fails to reboot, replace the new boot EPROMs with the original set and contact your Authorised Allied Telesyn distributor or reseller.

## Contacting Us

With locations covering all of the established markets in North America, Latin America and Europe, Allied Telesyn provides localized sales and technical support worldwide. To find our representative nearest you, visit Allied Telesyn on the web at: <http://www.alliedtelesyn.com>.